



MP KOVANIA[®]

VÝBER - KLUČKY A DOPLNKY NA DVERE

2024



MP KOVANIA[®]

KOVANIA NA DVERE, STAVBY A NÁBYTOK



Vstúpte do sveta MP KOVANIA, ktorý ponúka nekonečný výber kľúčiek, kovaní a doplnkov

Pod slovenskou značkou MP KOVANIA pôsobíme už viac ako 21 rokov v oblasti dverných kovaní a doplnkov na celom území Slovenskej republiky a od roku 2008 aj na území Českej republiky. Prevádzujeme veľkoobchodný a maloobchodný predaj so sieťou maloobchodných partnerov. V našom segmente si dlhodobo budujeme meno kvalitného a spoľahlivého partnera. Dbáme najmä na stabilitu, spoľahlivosť v poskytovaní produktov a služieb, na kvalitnú a ochotnú predajnú i popredajnú starostlivosť.

Pre ľahké kombinovanie a kompletné zladenie kovaní v interiéri ponúkame okrem kľúčiek od popredných európskych a ázijských výrobcov aj rozsiahly doplnkový sortiment ako mušle, madlá, závesy, zámky, iné doplnky na dvere a okná a ešte omnoho viac. Celé produktové portfólio si môžete prezrieť online v e-shope na www.mp-kovania.sk alebo v modernom showroome MP KOVANIA v Bratislave. Rozsiahle skladové zásoby nám umožňujú dodať väčšinu tovaru ihneď, resp. do 24 hodín od prijatia objednávky.

V tomto katalógu nájdete výber produktov z nášho širokého portfólia funkčných, štýlových, dizajnových, ale stále cenovo dostupných kľúčiek a doplnkov na dvere a okná pre akýkoľvek objekt. Spoznajte ponuku našich najpredávanejších značiek ako MP, TUPAI, APRILE, GRIFFWEK, FROSIO a ďalšie. Rozmanité materiály, tvary a povrchové úpravy nám umožňujú zabezpečiť individuálne riešenie pre každého zákazníka.

MP KOVANIA - to je nekonečný výber kľúčiek - stačí si vybrať tú správnu!



POMOCNÉ PRAVÍTKO

96
92
88
85

90

72

Typ otvoru a rozteč (vzdialenosť medzi osou kľučky a osou kľúča) sú vyrábané na objednávku podľa typu zámku.

Štandardná rozteč je 72 alebo 90 mm.
Na objednávku je možné vyraziť rozteč 85, 88, 92 alebo 96 mm.

Uvedená informácia platí len pre štítové kovania. Pri rozetovom kovaní sa neurčuje rozteč.

0

Rozteč

Vzdialenosť medzi osou kľučky a osou kľúča (BB, PZ a WC)

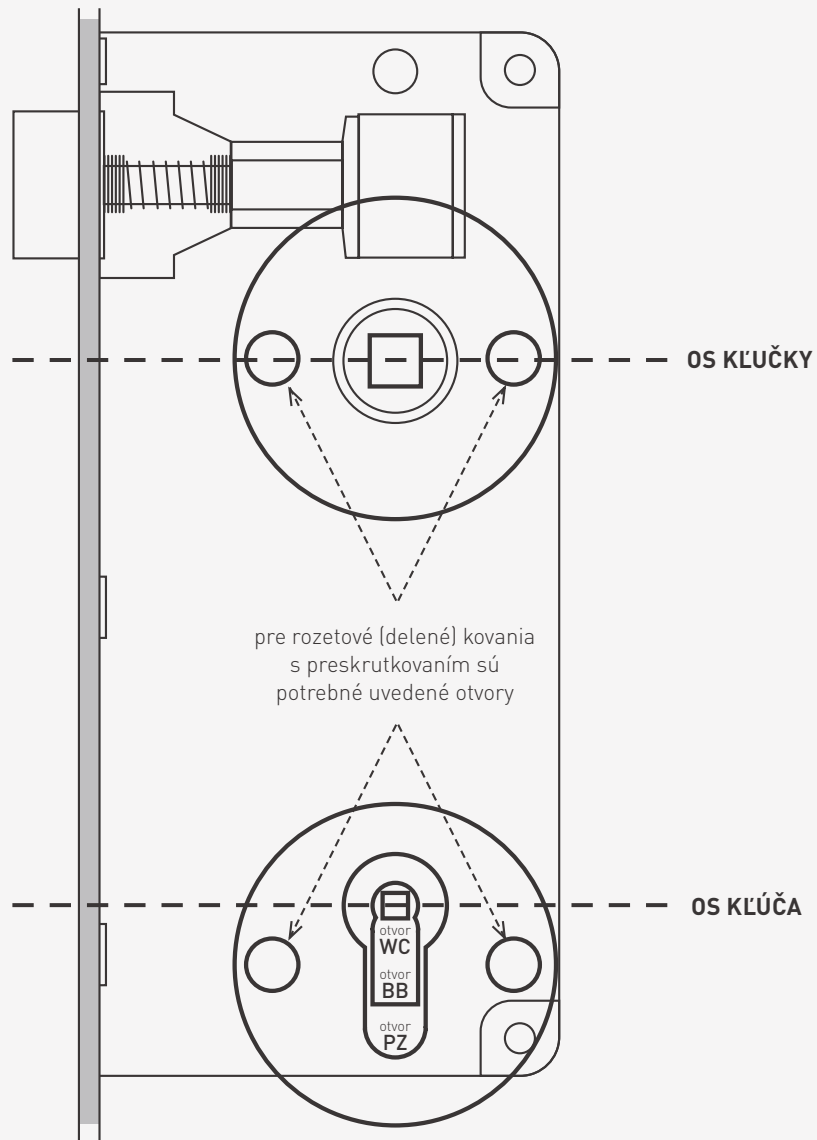

NIEKOĽKO RÁD PRED ZAKÚPENÍM KĽUČIEK

ŠTÍTOVÉ KĽUČKY

Pri objednávaní štítových kľučiek je potrebné vedieť vzdialenosť medzi osou kľučky a osou kľúča (rozteč). Štandardná vzdialenosť je 72 alebo 90 mm. Pre presné odmeranie vzdialenosti slúži pomocné pravítko zobrazené na predchádzajúcej strane. Štítové kľučky sú označené podľa tvaru skratkou SO (štít oválny), SH (štít hranatý), SOD (štít oválny dlhý) SOK (štít oválny krátky) a pre prípad úzkych štítov SHU (štít úzky hranatý).

UPOZORNENIE: Nakoľko otvory do štítových kľučiek sú vyrábané na objednávku, je nevyhnutné pri objednávaní uviesť správnu rozteč a typ otvorov. V opačnom prípade výmena kľučiek nemusí byť samozrejmosťou.

ROZETOVÉ KĽUČKY

Rozetové, čiže delené kľučky sú označované podľa tvaru skratkou R (okružla rozeta), HR (hraná rozeta), RT (obdĺžniková rozeta) alebo UOR (úzka oválna rozeta). Nakoľko sa väčšina rozetových kľučiek upevňuje preskrutkovaním cez celú hrúbku dverí v mieste zámku, je potrebné, aby boli v zámku na to určené otvory. Tie sú znázornené v nákrese na predchádzajúcej strane pri pomocnom pravítku.

TYPY OTVOROV



Skratka BB
označuje otvor
pre interiérový
kľúč (dózický)
v oválnom tvare



Skratka BBQ
označuje otvor
pre interiérový
kľúč (dózický)
v hranatom tvare



Skratka PZ
označuje otvor
pre cylindrickú
vločku (fabku)



Skratka WC
označuje WC sadu s kľúčom
(k WC sade je potrebný
záмок so spodným otvorom
na štvorhran s rozmerom
6 x 6 mm)

GULE

Pri kľučkách s guľou je potrebné uviesť, či ide o kľučku pravú (označujeme Re) alebo ľavú (označujeme Li). Štandardné prevedenie guľa - kľučka je dodávané s pevnou guľou.

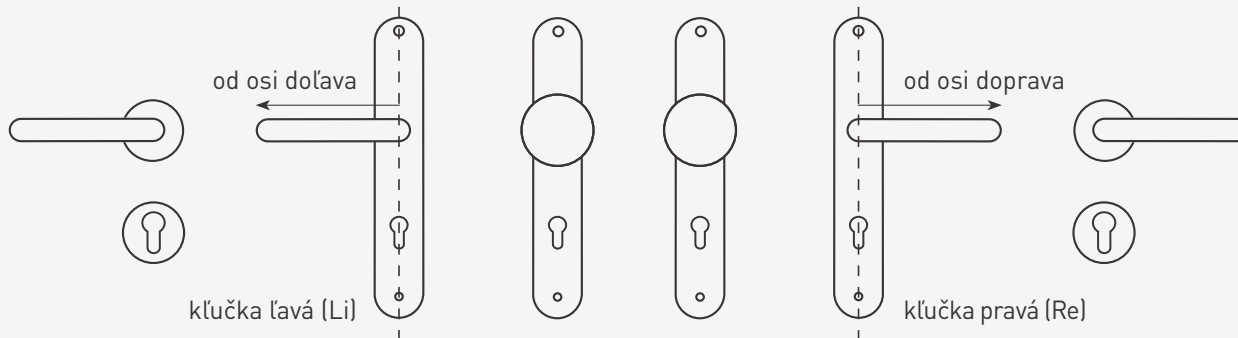

AKO SPRÁVNE OBJEDNÁVAŤ

Pre rýchle vybavenie objednávky je dôležité uviesť parametre špecifické pre rozetové a štítové kľučky.

Rozetové kľučky (delené)

- **názov modelu**, napr. MP - FAVORIT - R
- **povrch**, napr. NEM - nerez matná
- **typ otvoru** – BB, PZ alebo WC
- **prevedenie** – kľučka/kľučka
- **orientácia kľučky** – v prípade guľa/kľučka uviesť, či je kľučka ľavá Li alebo pravá Re
- **počet kusov**

Štítové kľučky

- **názov modelu**, napr. MP - Laura - SO
- **povrch**, napr. NIM - nikel matný
- **typ otvoru** – BB, PZ alebo WC
- **rozteč** napr. 72 mm
- **prevedenie** – kľučka/kľučka alebo guľa/kľučka
- **orientácia kľučky** – v prípade guľa/kľučka uviesť, či je kľučka ľavá Li alebo pravá Re
- **počet kusov**

Štandardne je kovanie dodávané so skrutkami a štvorhranom (8 x 8 mm) pre hrúbku dverí 40 mm. Pri hrubších dverách je potrebné uviesť ich presný rozmer v objednávke.

Pre expresné vybavenie vašej objednávky odporúčame navštíviť náš e-shop www.mp-kovania.sk a realizovať objednávku pohodlne online.

POVRCHOVÉ ÚPRAVY

Pri produktoch ponúkame širokú škálu povrchových úprav, pričom sú použité najmodernejšie technológie a materiály, ktoré zaručujú dlhú životnosť a odolnosť povrchu. Napriek tomu nie každá povrchová úprava je vhodná do každého prostredia. Pri jednotlivých povrchových úpravách sme vyznačili vhodnosť použitia symbolom:



Nízka záťaž

Vhodné do interiérov s nízkou frekvenciou pohybu ľudí, napr. byty, rodinné domy a pod.



Stredná záťaž

Vhodné do interiérov so zvýšenou frekvenciou pohybu ľudí, napr. ubytovne, penzióny, hotely, kancelárie a pod.



Vysoká záťaž

Vhodné do interiérov s vysokou frekvenciou pohybu ľudí, napr. administratívne priestory, nemocnice, predajne, čerpacie stanice, nákupné centrá a pod. Taktiež do exteriérov a v niektorých prípadoch aj do prostredia so zvýšenou vlhkosťou.

! **UPOZORENIE:** Povrchové úpravy skutočných produktov nemusia byť totožné s grafikou uvedenou v katalógu.

POVRCHOVÉ ÚPRAVY



BIM - BIELA MATNÁ
BIL - BIELA LESKLÁ



ZLL - ZLATÁ LESKLÁ



GRM - GRAFIT MATNÝ



CHL - CHRÓM LESKLÝ



ZLM.NAT - ZLATÁ MATNÁ



HNM - HNEDÁ MATNÁ



CHM - CHRÓM MATNÝ
STM - STRIEBORNÁ MATNÁ



ZLM - ZLATÁ MATNÁ



SIA - SIVÁ ANTIK
STA.T - STRIEBORNÁ ANTIK
TMAVÁ



NEM - NEREZ MATNÁ



BRM - BRONZ MATNÝ



CIM - ČIERNA MATNÁ
CIA - ČIERNA ANTIK



NIM - NIKEL MATNÝ



BRA - BRONZ ANTIK

PVD ZIRCONIUM

PVD ZIRCONIUM je špeciálna technológia výroby dekoratívnych povrchov s vynikajúcou odolnosťou voči opotrebeniu a poškrabaniu. Je farebne stála, čoho dôkazom je aj garantovaná 30-ročná záruka.



ZLL.PVD - ZLATÁ LESKLÁ
PVD



MEM.PVD - MEĎ MATNÁ
PVD



CIM.PVD - ČIERNA MATNÁ
PVD

BICOLOR



NIM/CHL - NIKEL MATNÝ/
CHRÓM LESKLÝ



NEM/NEL - NEREZ MATNÁ/
NEREZ LESKLÁ



GRM/CHL - GRAFIT MATNÝ/
CHRÓM LESKLÝ



CIM/CHL - ČIERNA MATNÁ/
CHRÓM LESKLÝ

PRAKTICKÉ INFORMÁCIE

Balenie tovaru

Balenie obsahuje dverné kovanie, doplnky, návod na montáž, potrebné skrutky, imbusové kľúče, prípadne šablónu na montáž kovania. Každý produkt je zabalený do ochranného obalu, ktorým je chránený voči poškodeniu pri manipulácii, resp. preprave.

Montáž

Montáž je veľmi dôležitá súčasť ovplyvňujúca funkčnosť výrobku. Z toho dôvodu je potrebné klásť zvýšený dôraz na jej správnosť. Pri kľúčkách je dôležité dôkladné, presné a priame zameranie otvorov. Otvory odporúčame vrátať až po dodaní tovaru, nakoľko údaje v katalógu sú informatívne. Neupravujte výrobky pri montáži a použite na montáž príslušné diely, ktoré sa nachádzajú v balení.

Pred inštaláciou kľučky je potrebné premazať mechaniku kovania univerzálnym mazivom, napr. PECOL P230.

Ošetrovanie

Na čistenie a ošetrovanie sa neodporúča používať agresívne chemikálie ani čistiace prostriedky. Kovanie je potrebné čistiť len mäkkou vlhkom handrou.

Po inštalácii odporúčame raz ročne premazať mechaniku kovania. Pri vydávaní neštandardných (písklavých) zvukov, alebo pri zasekávaní mechaniky, sa odporúča použiť univerzálne mazivo PECOL P230 – polosyntetický sprej, ktorý slúži na mazanie rôznych mechanických pohyblivých častí. Poskytuje ochranu proti korózii a je odolný voči vode, slanému a kyslému prostrediu.



REKLAMÁCIA A ZÁRUKA

Záruka a garancia kvality

Na produkty sa vzťahuje štandardná 2-ročná záruka, ktorá začína plynúť dátumom predaja uvedenom na pokladničnom doklade alebo faktúre. Na vybrané produkty v tomto katalógu je poskytovaná predĺžená záruka 5 rokov, ktorá je znázornená piktogramom.

Záruka sa nevzťahuje na poškodenie výrobku nesprávnym ošetrovaním, na opotrebovanie výrobku používaním, prípadne mechanickým poškodením (napr. kľúčmi, prstienkami a pod.), ani na výrobky, ktoré boli po zakúpení dodatočne upravované zákazníkom alebo jeho montážnikom, či umiestnené do nevhodného prostredia. Rovnako sa záruka nevzťahuje na znehodnotenie výrobku nekvalitnou montážou, nesprávnou manipuláciou, vlastnou prepravou a poškodenie prírodným živlom.

Pri dodržiavaní vyššie uvedených pokynov a upozornení je garantovaná dlhodobá životnosť výrobkov.

Výmena tovaru

Každý produkt je zabalený do ochranného obalu, ktorým je chránený voči poškodeniu pri manipulácii, resp. preprave. **Pri zistení vady alebo nedostatku, z ktorého vyplýva nárok na výmenu alebo reklamáciu produktu, je potrebné jednotlivé diely zabaliť tak, aby nedošlo k ich ďalšiemu poškodeniu** a doručiť ich na adresu MP KOVANIA.

CENY

Ceny v katalógu sú platné v čase vydania katalógu. Sú uvedené za kompletný výrobok, v prípade kľúčiek za set bez DPH v € alebo s 20% DPH v €. Prostredníctvom QR kódu, ktorý nájdete pri každom produkte, si rýchlo a jednoducho môžete overiť aktuálnu cenu, dostupnosť tovaru a ďalšie dôležité informácie.

Z dôvodu nestability cien materiálov na svetovom trhu si vyhradujeme právo na úpravu cien bez predošlého upozornenia.

Prepravné podmienky pre obchodných partnerov v rámci SR:

Pri odbere tovaru **na faktúru** v hodnote nižšej ako 100,00 € bez DPH po zľave bude k cene tovaru pripočítané prepravné a balné vo výške **5,00 € bez DPH**.

Pri odbere tovaru **na dobierku** v hodnote nižšej ako 100,00 € bez DPH po zľave bude k cene tovaru pripočítané prepravné a balné vo výške **6,50 € bez DPH**.

Pri odbere tovaru v hodnote nad **100,00 € bez DPH** po zľave je prepravné a balné **ZADARMO!** Prepravné mimo SR a za nadrozmerné zásielky je stanovené individuálne.

Kompletný sortiment s aktuálnymi cenami nájdete vždy na www.mp-kovania.sk.



Po načítaní QR kódu pri produkte budete presmerovaný **primo na vybraný produkt** v našom e-shope.





Príslušenstvo pre rôzne typy zámkov

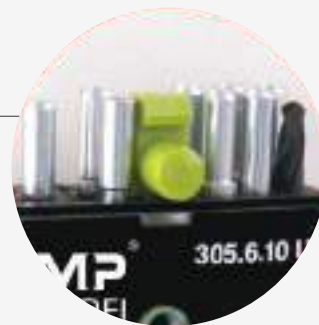

Otvory pre vŕtanie rozetových kľučiek



Otvory pre vŕtanie roziet

KVALITNE NAMONTOVANÁ KLÚČKA – ZÁRUKA DLHODOBEJ ŽIVOTNOSTI

Vzhľadom k dôležitosti správnej montáže kľučiek dávame do pozornosti **MP – PROFI Šablónu**. Umožňuje presne a kolmo vyvŕtať otvory, a preto sa odporúča používať pri montáži všetkých rozetových kľučiek s výstupkami. MP – PROFI Šablónu je možné nastaviť na rôzne rozteče zadlabávacích zámkov. Umožňuje rýchlo reagovať na rôzne montážne situácie, nakoľko obsahuje všetky potrebné nástavce pre montáž, vrátane vrtáku s priemerom 7 mm. Je dostupná k zakúpeniu alebo k zapožičaniu.

MP – PROFI Šablóna

- Rýchla a **jednoduchá** montáž kľučky
- Zaručená **presnosť** vŕtania
- Garancia **kolmého** vŕtania
- **Nastaviteľnosť** roztečí
- **Univerzálnosť použitia** pre BB, PZ a WC

	Cena v € bez DPH	Cena v € s DPH
MP – PROFI Šablóna	100,00	120,00
Zapožičanie na 1 deň	10,00	12,00

OBSAH - KĽUČKY

séria ALUMINIUM rozetové a štítové hliníkové kľučky	16 - 35
séria NEREZ rozetové a štítové nerezové kľučky	38 - 78
séria 3SM rozetové nerezové kľučky s 3 mm magnetickou rozetou	82 - 91
séria S6 rozetové kľučky s 6 mm rozetou	94 - 109
séria BICOLOR rozetové kľučky s kombinovanými povrchovými úpravami	112 - 125
séria KLASIK štítové a okenné kľučky	128 - 181
VÝBER KĽUČIEK Z EURÓPSKYCH ZNAČIEK TUPAI, GRIFFWERK, APRILE, FROSIO	184 - 259
séria OKENNÉ KOVANIA kľučky na okná a eurookná	262 - 287
séria BEZPEČNOSTNÉ KOVANIA bezpečnostné a spevnené kovania	290 - 305

OBSAH - DOPLNKY

DVERNÉ MADLÁ	308 - 323
MUŠLE NA POSUVNÉ DVERE, POSUVNÉ SYSTÉMY	324 - 372
ZÁVESY, ZÁMKY, ZARÁŽKY, STAVAČE, ZÁSTRČE	374 - 397
TESNIACE LIŠTY A DVERNÉ PRAHY	398 - 409
SAMOZATVÁRAČE	410 - 418
PANIKOVÉ KOVANIA	420 - 438
OKOPOVÉ PLECHY, VETRACIE MRIEŽKY, PRIEZORNÍKY, ČÍSLICE	440 - 453
CYLINDRICKÉ VLOŽKY A UZAMYKACIE SYSTÉMY	454 - 467
KOVANIA NA SKLO	468 - 475

ALUMINIUM

séria **Aluminium**

Rozetové a štítové hliníkové kľučky



ALUMINIUM

ROZETOVÉ A ŠTÍTOVÉ
HLINÍKOVÉ KLUČKY



VYSVETLIVKY



predĺžená záruka 3 / 5 rokov



obsahuje/ neobsahuje vratný
mechanizmus kľučky - pružinu



plastová rozeta



možnosť doobjednať skrutky
na preskrutkovanie cez dvere



súčasťou balenia je sada skrutiek
na preskrutkovanie cez dvere



súčasťou balenia sú samorezné skrutky
3 x 20 mm v príslušnom počte ku kovaniu



univerzálna montáž pravo-ľavé prevedenie



rozeta s výstupkami (zabraňuje
nežiadanému pohybu rozety na dverách)



rozteč - vzdialenosť medzi osou kľučky a osou
kľúča 72 alebo 90 mm

MATERIÁL: HLINÍK



STM STRIEBORNÁ MATNÁ



BIL BIELA LESKLÁ



NIM NIKEL MATNÝ

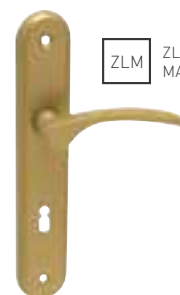

ZLM ZLATÁ MATNÁ



HNA HNEDÁ ANTIK

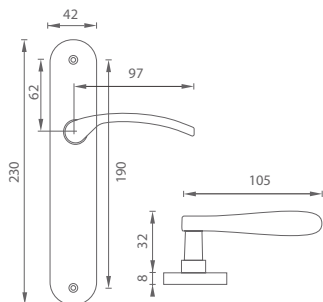

HNL HNEDÁ LESKLÁ



SIA SIVÁ ANTIK



CIM ČIERNA MATNÁ (N)



KE - LAURA - SO

	Cena za set v €	STM, BIL, CIM, ZLM, HNA, HNL, SIA		NIM	
		bez DPH	s DPH	bez DPH	s DPH
kl./kl. s BB otvorom pre kľúč		6,00	7,20	8,00	9,60
kl./kl. s PZ otvorom pre vložku		6,00	7,20	8,00	9,60
kl./kl. s WC kľúčom		7,00	8,40	9,00	10,80
guľa/kl. s PZ otvorom pre vložku		7,00	8,40	9,00	10,80



OVERTE CENU



STM STRIEBORNÁ
MATNÁ

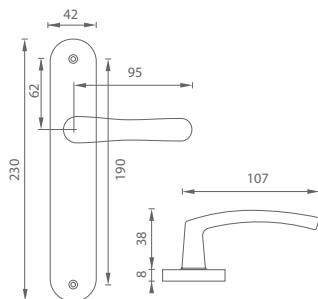

BIL BIELA
LESKLÁ



NIM NIKEL
MATNÝ

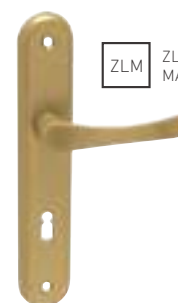

ZLM ZLATÁ
MATNÁ



HNA HNEDÁ
ANTIK



HNL HNEDÁ
LESKLÁ



KE - MICHAELA - SO

	Cena za set v €	STM, BIL, ZLM, HNA, HNL, SIA		NIM	
		bez DPH	s DPH	bez DPH	s DPH
kl./kl. s BB otvorom pre kľúč	6,00	7,20	8,00	9,60	
kl./kl. s PZ otvorom pre vložku	6,00	7,20	8,00	9,60	
kl./kl. s WC kľúčom	7,00	8,40	9,00	10,80	
guľa/kl. s PZ otvorom pre vložku	7,00	8,40	9,00	10,80	

OVERTE
CENU



MATERIÁL: HLINÍK

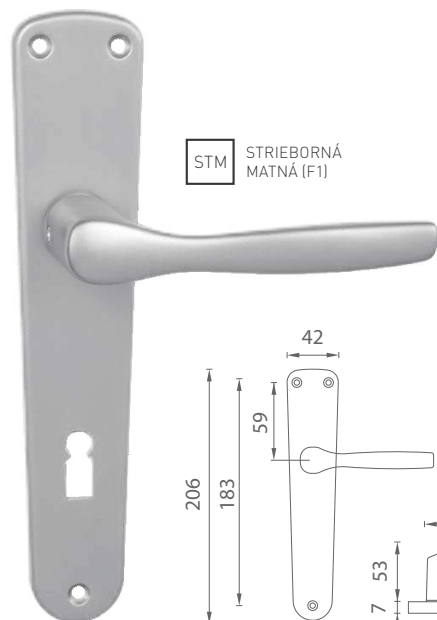

STM STRIEBORNÁ
MATNÁ (F1)

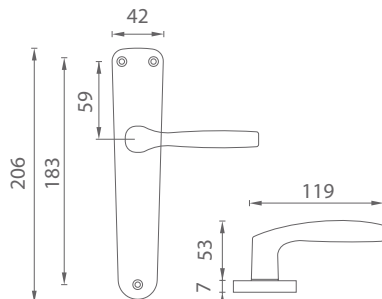

NIM NIKEL
MATNÝ (F8)

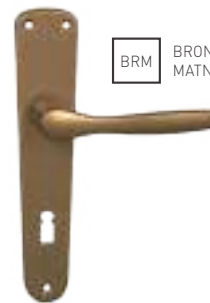





BRM BRONZ
MATNÝ (F4)



OVERTE
CENU

BA - LUXOR B - SO

	STM, BRM		NIM	
	bez DPH	s DPH	bez DPH	s DPH
kľ./kľ. bez otvoru	10,40	12,48	11,10	13,32
kľ./kľ. s BB otvorom pre kľúč 	10,40	12,48	11,10	13,32
kľ./kľ. s PZ otvorom pre vložku 	10,40	12,48	11,10	13,32
kľ./kľ. s WC kľúčom a ukazovateľom 	16,30	19,56	-	-
kľ./kľ. s WC kľúčom 	16,30	19,56	17,60	21,12
guľa/kľ. s PZ otvorom pre vložku 	17,20	20,64	18,55	22,26

3
ROKY ZÁRUKA



72
90
ROZTEČ



STM STRIEBORNÁ
MATNÁ (F1)



NIM NIKEL
MATNÝ (F8)





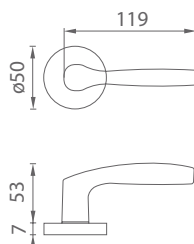

BRM BRONZ
MATNÝ (F4)



OVERTE
CENU

BA - LUXOR - R

Cena za set v €	STM, BRM		NIM	
	bez DPH	s DPH	bez DPH	s DPH
kľ./kľ. bez spodnej rozety	8,90	10,68	9,60	11,52
kľ./kľ. + rozety BB 	11,00	13,20	11,90	14,28
kľ./kľ. + rozety PZ 	11,00	13,20	11,90	14,28
kľ./kľ. + rozety WC s ukazovateľom 	16,30	19,56	17,50	21,00
kľ./kľ. + rozety WC 	18,70	22,44	20,10	24,12
guľa/kľ. + rozety PZ 	17,05	20,46	18,60	22,32

3
ROKY ZÁRUKA



PR



MATERIÁL: HLINÍK

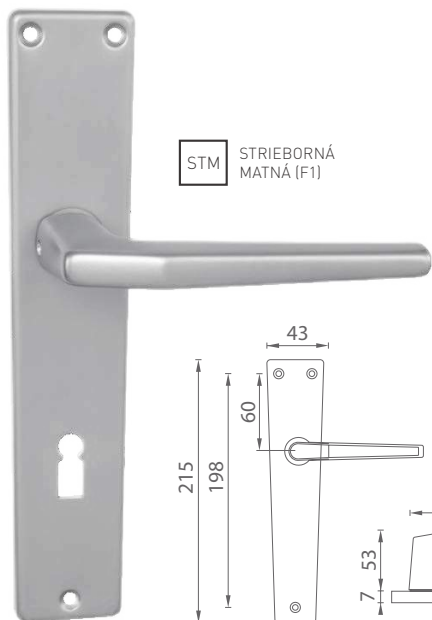

STM STRIEBORNÁ MATNÁ (F1)



NIM NIKEL MATNÝ (F8)







BRM BRONZ MATNÝ (F4)



OVERTE CENU

BA - LUCIA - SH

	Cena za set v €	STM, BRM		NIM	
		bez DPH	s DPH	bez DPH	s DPH
kľ./kľ. bez otvoru		10,60	12,72	11,40	13,68
kľ./kľ. s BB otvorom pre kľúč		10,60	12,72	11,40	13,68
kľ./kľ. s PZ otvorom pre vložku		10,60	12,72	11,40	13,68
kľ./kľ. s WC kľúčom a ukazovateľom		16,50	19,80	-	-
kľ./kľ. s WC kľúčom		16,50	19,80	17,90	21,48
guľa/kľ. s PZ otvorom pre vložku		17,30	20,76	18,70	22,44

3
BODY ZÁRUKA



72
90
ROZTEČ



STM STRIEBORNÁ
MATNÁ (F1)



NIM NIKEL
MATNÝ (F8)





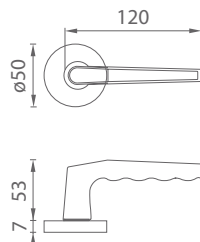

BRM BRONZ
MATNÝ (F4)



OVERTE
CENU

BA - LUCIA - R

Cena za set v €	STM, BRM		NIM	
	bez DPH	s DPH	bez DPH	s DPH
kľ./kľ. bez spodnej rozety	9,10	10,92	9,90	11,88
kľ./kľ. + rozety BB 	11,20	13,44	12,20	14,64
kľ./kľ. + rozety PZ 	11,20	13,44	12,20	14,64
kľ./kľ. + rozety WC s ukazovateľom 	16,50	19,80	17,80	21,36
kľ./kľ. + rozety WC 	18,90	22,68	20,40	24,48
guľa/kľ. + rozety PZ 	17,15	20,58	18,75	22,50

3
ROKY ZÁRUKA



PR



MATERIÁL: HLINÍK



STM STRIEBORNÁ MATNÁ (F1)



NIM NIKEL MATNÝ (F8)



BRM BRONZ MATNÝ (F4)

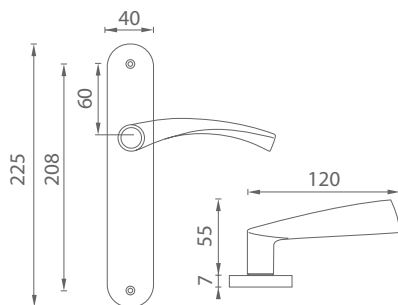

OVERTE CENU

BA - TORNADO - SO

	Cena za set v €	STM, BRM		NIM	
		bez DPH	s DPH	bez DPH	s DPH
kľ./kľ. bez otvoru		13,50	16,20	14,50	17,40
kľ./kľ. s BB otvorom pre kľúč		13,50	16,20	14,50	17,40
kľ./kľ. s PZ otvorom pre vložku		13,50	16,20	14,50	17,40
kľ./kľ. s WC kľúčom a ukazovateľom		19,30	23,16	-	-
kľ./kľ. s WC kľúčom		19,40	23,28	21,00	25,20
guľa/kľ. s PZ otvorom pre vložku		18,75	22,50	20,25	24,30

3
ROKY ZÁRUKA



72
90
ROZTEČ



STM STRIEBORNÁ
MATNÁ (F1)



NIM NIKEL
MATNÝ (F8)





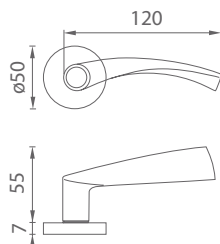







BRM BRONZ
MATNÝ (F4)



OVERTE
CENU

BA - TORNADO - R

	Cena za set v €	STM, BRM		NIM	
		bez DPH	s DPH	bez DPH	s DPH
kľ./kľ. bez spodnej rozety		11,80	14,16	12,80	15,36
kľ./kľ. + rozety BB	 	13,90	16,68	15,10	18,12
kľ./kľ. + rozety PZ	 	13,90	16,68	15,10	18,12
kľ./kľ. + rozety WC s ukazovateľom	 	19,20	23,04	20,70	24,84
kľ./kľ. + rozety WC	 	21,60	25,92	23,30	27,96
guľa/kľ. + rozety PZ	 	18,50	22,20	20,20	24,24

3
ROKY ZÁRUKA



PR



MATERIÁL: HLINÍK

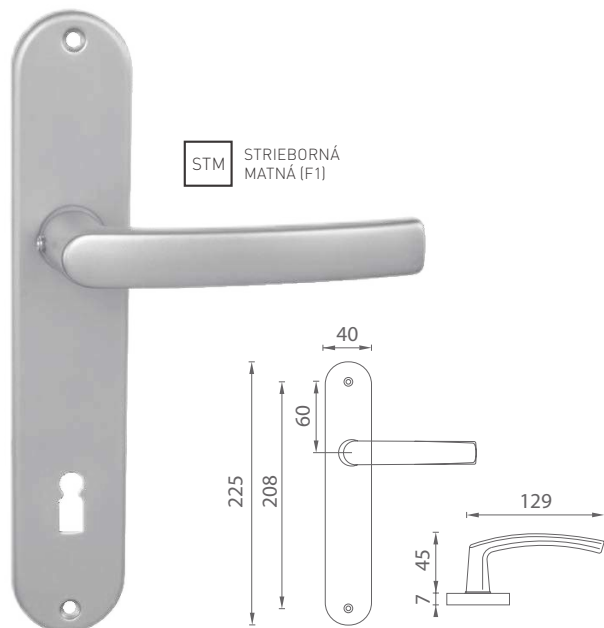

STM STRIEBORNÁ MATNÁ (F1)



NIM NIKEL MATNÝ (F8)

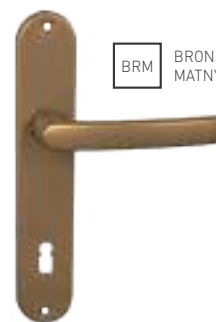





BRM BRONZ MATNÝ (F4)



OVERTE CENU

BA - MIRA - SO

	Cena za set v €	STM, BRM		NIM	
		bez DPH	s DPH	bez DPH	s DPH
kľ./kľ. bez otvoru		11,60	13,92	12,30	14,76
kľ./kľ. s BB otvorom pre kľúč 		11,60	13,92	12,30	14,76
kľ./kľ. s PZ otvorom pre vložku 		11,60	13,92	12,30	14,76
kľ./kľ. s WC kľúčom a ukazovateľom 		17,40	20,88	-	-
kľ./kľ. s WC kľúčom 		17,50	21,00	18,80	22,56
guľa/kľ. s PZ otvorom pre vložku 		17,80	21,36	19,15	22,98

3
ROZTEČ



72
90
ROZTEČ



STM STRIEBORNÁ
MATNÁ (F1)



NIM NIKEL
MATNÝ (F8)

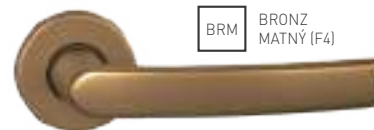



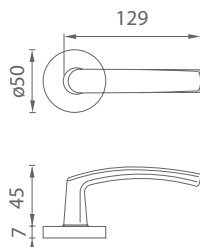







BRM BRONZ
MATNÝ (F4)



OVERTE
CENU

BA - MIRA - R

	Cena za set v €	STM, BRM		NIM	
		bez DPH	s DPH	bez DPH	s DPH
kľ./kľ. bez spodnej rozety		9,90	11,88	10,60	12,72
kľ./kľ. + rozety BB	 	12,00	14,40	12,90	15,48
kľ./kľ. + rozety PZ	 	12,00	14,40	12,90	15,48
kľ./kľ. + rozety WC s ukazovateľom	 	17,30	20,76	18,50	22,20
kľ./kľ. + rozety WC	 	19,70	23,64	21,10	25,32
guľa/kľ. + rozety PZ	 	17,55	21,06	19,10	22,92

3
BODY ZÁRUKA



PR



MATERIÁL: HLINÍK

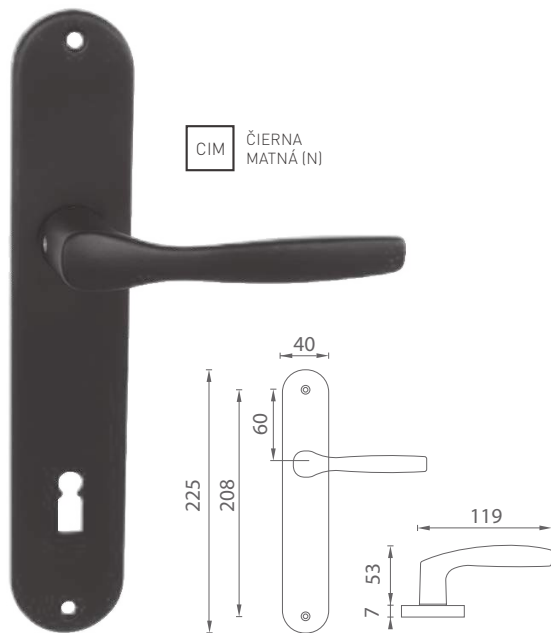

CIM ČIERNA MATNÁ (N)

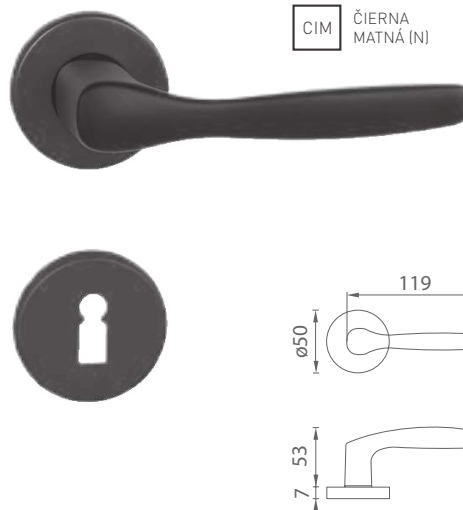

CIM ČIERNA MATNÁ (N)



BA - LUXOR - SO

	Cena za set v €	bez DPH	s DPH
kľ./kľ. bez otvoru		14,80	17,76
kľ./kľ. s BB otvorom pre kľúč		14,80	17,76
kľ./kľ. s PZ otvorom pre vložku		14,80	17,76
kľ./kľ. s WC kľúčom		22,90	27,48
guľa/kľ. s PZ otvorom pre vložku		21,90	26,28

OVERTE CENU

3 ROKY ZÁRUKA



72 90 ROZTEC

BA - LUXOR - R

	Cena za set v €	bez DPH	s DPH
kľ./kľ. bez spodnej rozety		12,30	14,76
kľ./kľ. + rozety BB		16,00	19,20
kľ./kľ. + rozety PZ		16,00	19,20
kľ./kľ. + rozety WC s ukazovateľom		23,30	27,96
kľ./kľ. + rozety WC		25,50	30,60
guľa/kľ. + rozety PZ		21,00	25,20

3 ROKY ZÁRUKA



PR





MATERIÁL: HLINÍK

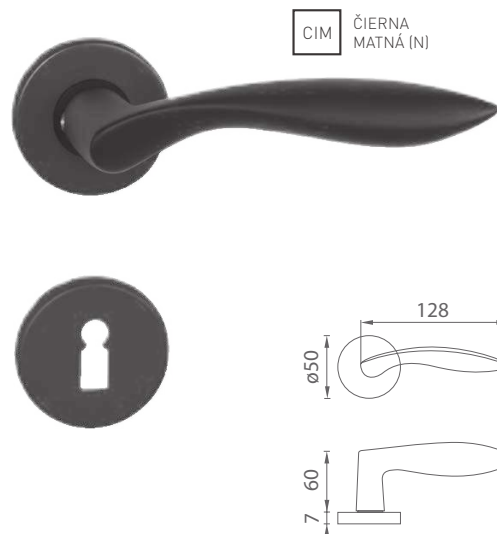
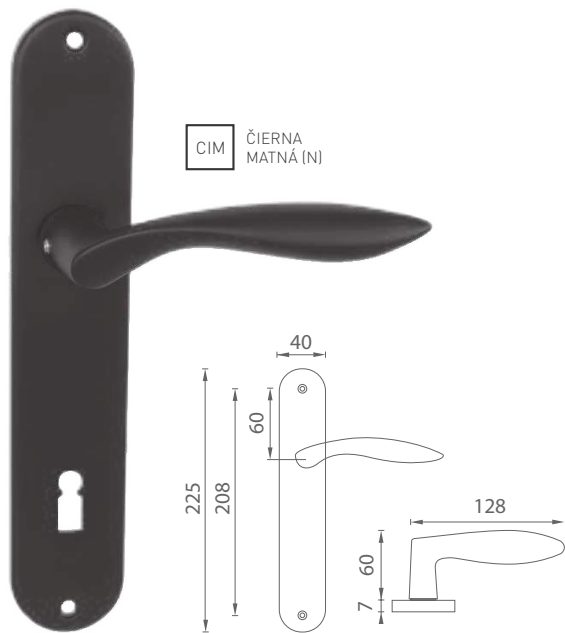

BA - CLAUDIA - SO

	Cena za set v €	bez DPH	s DPH
kľ./kľ. bez otvoru		19,20	23,04
kľ./kľ. s BB otvorom pre kľúč		19,20	23,04
kľ./kľ. s PZ otvorom pre vložku		19,20	23,04
kľ./kľ. s WC kľúčom		27,30	32,76
guľa/kľ. s PZ otvorom pre vložku		24,10	28,92

OVERTE CENU

3
ROKY ZÁRUKA



72
90
ROZTEC

BA - CLAUDIA - R

	Cena za set v €	bez DPH	s DPH
kľ./kľ. bez spodnej rozety		16,70	20,04
kľ./kľ. + rozety BB		20,40	24,48
kľ./kľ. + rozety PZ		20,40	24,48
kľ./kľ. + rozety WC s ukazovateľom		27,70	33,24
kľ./kľ. + rozety WC		29,90	35,88
guľa/kľ. + rozety PZ		24,55	29,46

3
ROKY ZÁRUKA



PR



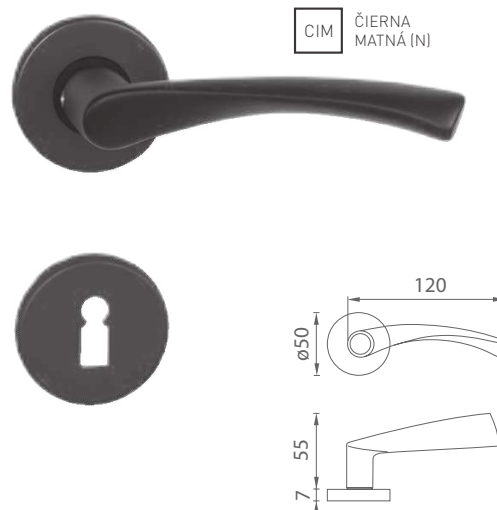
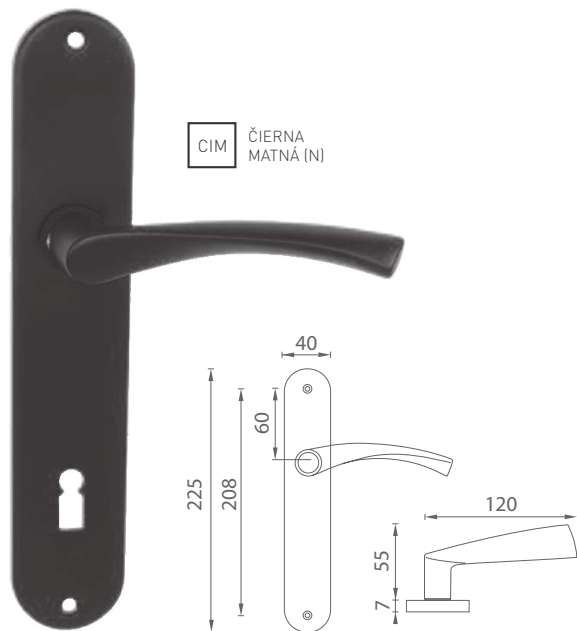

OVERTE
CENU

BA - TORNADO - SO

	Cena za set v €	bez DPH	s DPH
kľ./kľ. bez otvoru		18,00	21,60
kľ./kľ. s BB otvorom pre kľúč		18,00	21,60
kľ./kľ. s PZ otvorom pre vložku		18,00	21,60
kľ./kľ. s WC kľúčom		26,10	31,32
guľa/kľ. s PZ otvorom pre vložku		23,50	28,20

3
ROKY ZÁRUKA



72
90
ROZTEC

BA - TORNADO - R

	Cena za set v €	bez DPH	s DPH
kľ./kľ. bez spodnej rozety		15,50	18,60
kľ./kľ. + rozety BB		19,20	23,04
kľ./kľ. + rozety PZ		19,20	23,04
kľ./kľ. + rozety WC s ukazovateľom		26,50	31,80
kľ./kľ. + rozety WC		28,70	34,44
guľa/kľ. + rozety PZ		23,95	28,74

3
ROKY ZÁRUKA



PR



MATERIÁL: HLINÍK

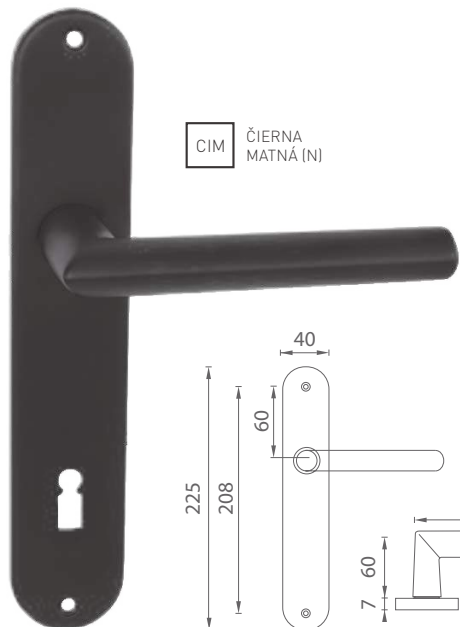

CIM ČIERNA MATNÁ (N)

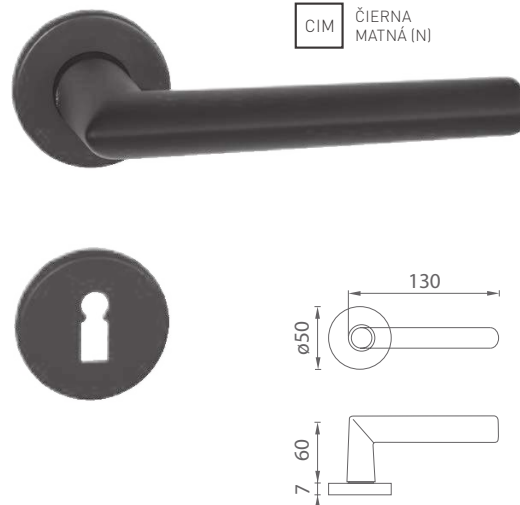

CIM ČIERNA MATNÁ (N)



OVERTE CENU

BA - NEVADA - SO

	Cena za set v €	bez DPH	s DPH
kľ./kľ. bez otvoru		17,30	20,76
kľ./kľ. s BB otvorom pre kľúč		17,30	20,76
kľ./kľ. s PZ otvorom pre vložku		17,30	20,76
kľ./kľ. s WC kľúčom		25,40	30,48
guľa/kľ. s PZ otvorom pre vložku		23,15	27,78

3
ROKY ZÁRUKA



72
90
ROZTEC

BA - NEVADA - R

	Cena za set v €	bez DPH	s DPH
kľ./kľ. bez spodnej rozety		14,80	17,76
kľ./kľ. + rozety BB		18,50	22,20
kľ./kľ. + rozety PZ		18,50	22,20
kľ./kľ. + rozety WC s ukazovateľom		25,80	30,96
kľ./kľ. + rozety WC		28,00	33,60
guľa/kľ. + rozety PZ		23,60	28,32

3
ROKY ZÁRUKA



PR



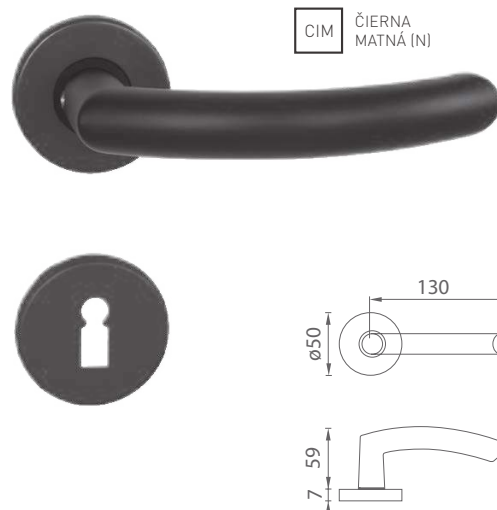
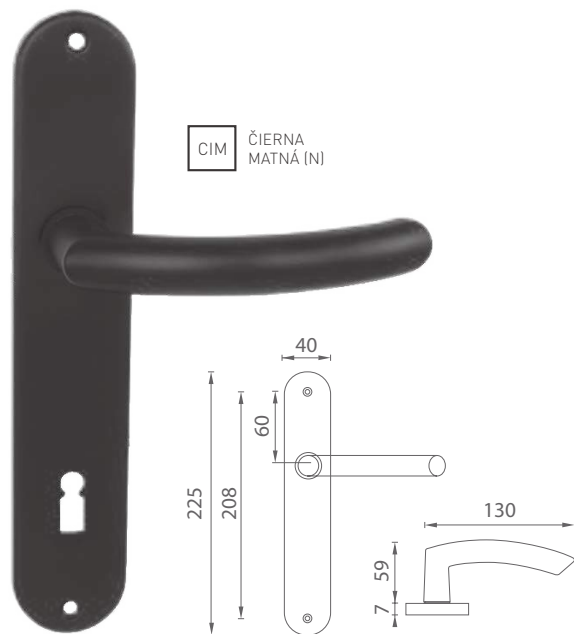

OVERTE
CENU

BA - NERO - SO

	Cena za set v €	bez DPH	s DPH
kľ./kľ. bez otvoru		17,30	20,76
kľ./kľ. s BB otvorom pre kľúč		17,30	20,76
kľ./kľ. s PZ otvorom pre vložku		17,30	20,76
kľ./kľ. s WC kľúčom		25,40	30,48
guľa/kľ. s PZ otvorom pre vložku		21,65	25,98

3
ROKY ZÁRUKA



72
90
ROZTEC

BA - NERO - R

	Cena za set v €	bez DPH	s DPH
kľ./kľ. bez spodnej rozety		14,80	17,76
kľ./kľ. + rozety BB		18,50	22,20
kľ./kľ. + rozety PZ		18,50	22,20
kľ./kľ. + rozety WC s ukazovateľom		25,80	30,96
kľ./kľ. + rozety WC		28,00	33,60
guľa/kľ. + rozety PZ		23,60	28,32

3
ROKY ZÁRUKA



PR



MATERIÁL: HLINÍK

MATERIÁL: TVRDENÝ POLYAMID



GRM GRAFIT
MATNÝ (MP67)

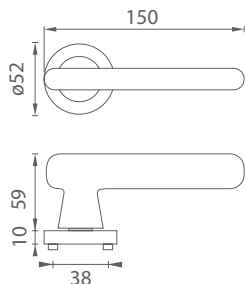

i Tvrdený polyamid - farebne stály materiál s mimoriadnou odolnosťou.



CIM ČIERNA
MATNÁ (MP54)

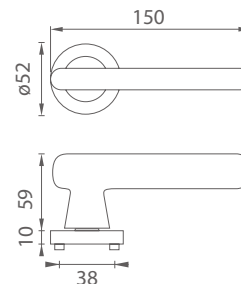

i Tvrdený polyamid - farebne stály materiál s mimoriadnou odolnosťou.



CE - CASTA - R

	Cena za set v €	bez DPH	s DPH
kľ./kľ. bez spodnej rozety		23,50	28,20
kľ./kľ. + rozety BB		27,50	33,00
kľ./kľ. + rozety PZ		27,50	33,00
kľ./kľ. + rozety WC		31,50	37,80

OVERTE
CENU

5
MATERIÁL



CE - CASTA - R

	Cena za set v €	bez DPH	s DPH
kľ./kľ. bez spodnej rozety		23,50	28,20
kľ./kľ. + rozety BB		27,50	33,00
kľ./kľ. + rozety PZ		27,50	33,00
kľ./kľ. + rozety WC		31,50	37,80

5
MATERIÁL



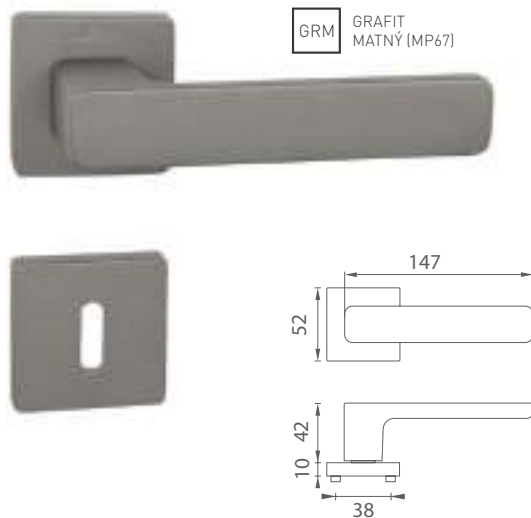

GRM GRAFIT
MATNÝ (MP67)

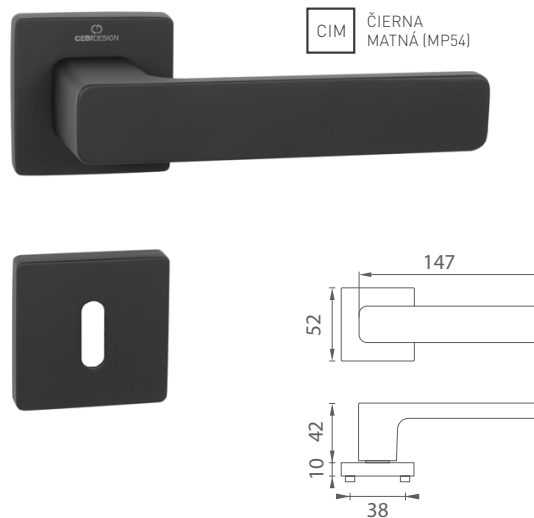

CIM ČIERNA
MATNÁ (MP54)

i Tvrdený polyamid - farebne stály materiál s mimoriadnou odolnosťou.

i Tvrdený polyamid - farebne stály materiál s mimoriadnou odolnosťou.



CE - FLAT - HR

	Cena za set v €	bez DPH	s DPH
kľ./kľ. bez spodnej rozety		23,50	28,20
kľ./kľ. + rozety BB		27,50	33,00
kľ./kľ. + rozety PZ		27,50	33,00
kľ./kľ. + rozety WC		31,50	37,80



OVERTE
CENU

CE - FLAT - HR

	Cena za set v €	bez DPH	s DPH
kľ./kľ. bez spodnej rozety		23,50	28,20
kľ./kľ. + rozety BB		27,50	33,00
kľ./kľ. + rozety PZ		27,50	33,00
kľ./kľ. + rozety WC		31,50	37,80



MATERIÁL: TVRDENÝ POLYAMID

MPK®

KLUČKY NA DVERE

séria **NEREZ**

Rozetové a štítové nerezové kľučky



MPK[®]

NEREZ

ROZETOVÉ A ŠTÍTOVÉ
NEREZOVÉ KLUČKY

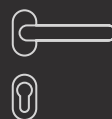
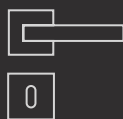

KONŠTRUKCIA KĽUČIEK



VYSVETLIVKY

5
ROKOV ZÁRUKA

predĺžená záruka 5 rokov



súčasťou balenia je sada skrutiek na preskrutkovanie cez dvere

TR 3
100 tis.

TR 4
200 tis.

trieda záťaže - počet cyklov v tisícoch



obsahuje vratný mechanizmus kľučky - pružinu



súčasťou balenia sú samorezné skrutky 3 x 20 mm v príslušnom počte ku kovaníu

72
ROZTEČ

rozteč - vzdialenosť medzi osou kľučky a osou kľúča (možnosť vyraziť len rozteč 72 mm)



rozeta s výstupkami (zabraňuje nežiadanému pohybu rozety na dverách)



pre protipožiarne a dymotesné dvere

72
90
ROZTEČ

rozteč - vzdialenosť medzi osou kľučky a osou kľúča je štandardne 72 alebo 90 mm (na objednávku možnosť vyraziť rozmery 85, 88, 92 alebo 96 mm)

KR

kovová rozeta

MATERIÁL: NEREZ

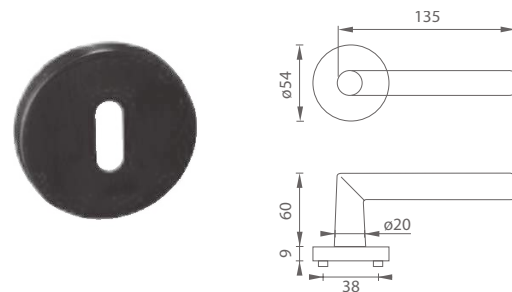
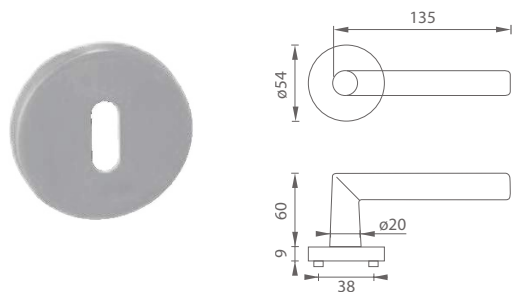
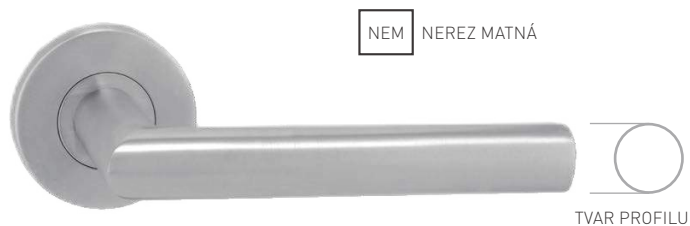

i Kľučka na eurookno na strane 268



OVERTE CENU

MP - FAVORIT - R

	Cena za set v €	bez DPH	s DPH
kľ./kľ. bez spodnej rozety		12,50	15,00
kľ./kľ. + rozety BB		15,00	18,00
kľ./kľ. + rozety PZ		15,00	18,00
kľ./kľ. + rozety WC		22,50	27,00
kľ./kľ. + rozety WC s ukazovateľom		22,50	27,00
guľa/kľ. + rozety PZ		22,00	26,40

5
ROZETOVÝ



TR 4
200 tis.

MP - FAVORIT - R

	Cena za set v €	bez DPH	s DPH
kľ./kľ. bez spodnej rozety		15,00	18,00
kľ./kľ. + rozety BB		18,50	22,20
kľ./kľ. + rozety PZ		18,50	22,20
kľ./kľ. + rozety WC		27,50	33,00
guľa/kľ. + rozety PZ		28,50	34,20

5
ROZETOVÝ



TR 4
200 tis.



NEM NEREZ MATNÁ

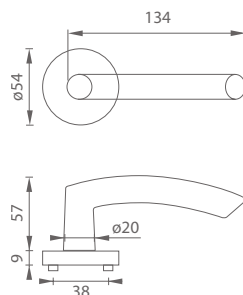

NEM NEREZ MATNÁ

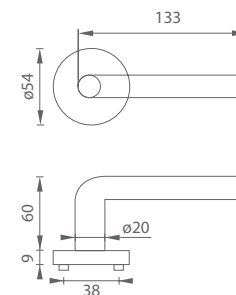

OVERTE
CENU

MP - NERO - R

	Cena za set v €	bez DPH	s DPH
kľ./kľ. bez spodnej rozety		12,50	15,00
kľ./kľ. + rozety BB		15,00	18,00
kľ./kľ. + rozety PZ		15,00	18,00
kľ./kľ. + rozety WC		22,50	27,00
kľ./kľ. + rozety WC s ukazovateľom		22,50	27,00
guľa/kľ. + rozety PZ		22,00	26,40

5
ROZETKY



TR 4
200 tis.

MP - MONA - R

	Cena za set v €	bez DPH	s DPH
kľ./kľ. bez spodnej rozety		12,50	15,00
kľ./kľ. + rozety BB		15,00	18,00
kľ./kľ. + rozety PZ		15,00	18,00
kľ./kľ. + rozety WC		22,50	27,00
kľ./kľ. + rozety WC s ukazovateľom		22,50	27,00
guľa/kľ. + rozety PZ		22,00	26,40

5
ROZETKY



TR 4
200 tis.

MATERIÁL: NEREZ

MATERIÁL: NEREZ



NEM NEREZ MATNÁ

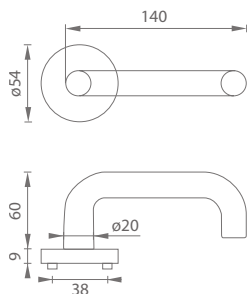

NEM NEREZ MATNÁ

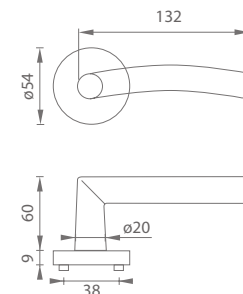

OVERTE
CENU

MP - COSLAN - R

	Cena za set v €	bez DPH	s DPH
kľ./kľ. bez spodnej rozety		12,50	15,00
kľ./kľ. + rozety BB		15,00	18,00
kľ./kľ. + rozety PZ		15,00	18,00
kľ./kľ. + rozety WC		22,50	27,00
kľ./kľ. + rozety WC s ukazovateľom		22,50	27,00
guľa/kľ. + rozety PZ		22,00	26,40

5

MPK KOVANIA



KR



TR 4

200 tis.

MP - SWING - R

	Cena za set v €	bez DPH	s DPH
kľ./kľ. bez spodnej rozety		12,50	15,00
kľ./kľ. + rozety BB		15,00	18,00
kľ./kľ. + rozety PZ		15,00	18,00
kľ./kľ. + rozety WC		22,50	27,00
kľ./kľ. + rozety WC s ukazovateľom		22,50	27,00
guľa/kľ. + rozety PZ		22,00	26,40

5

MPK KOVANIA



KR



TR 4

200 tis.

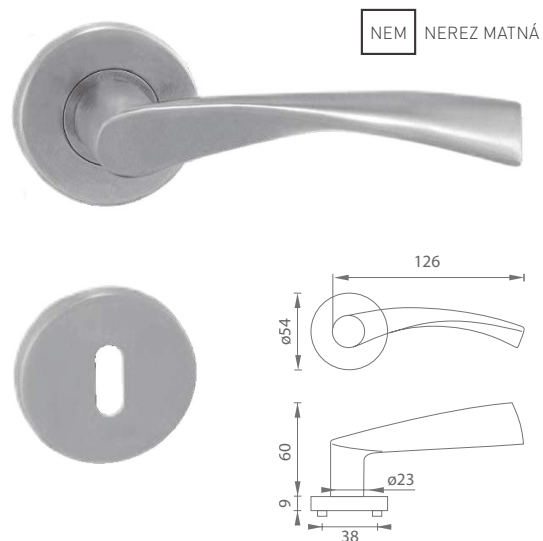

NEM NEREZ MATNÁ

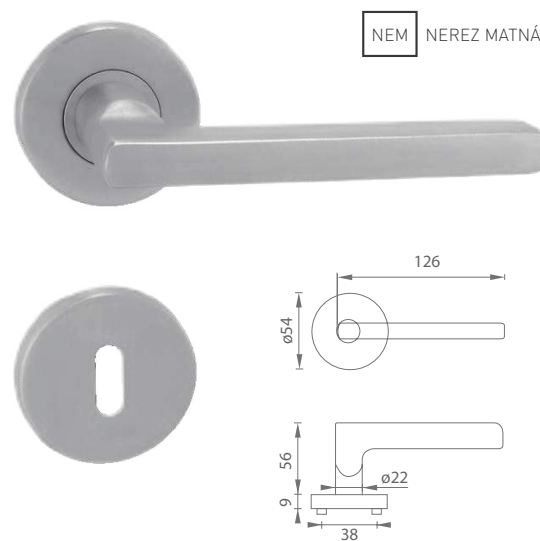

NEM NEREZ MATNÁ



OVERTE
CENU

MP - TORNADO - R

	Cena za set v €	bez DPH	s DPH
kľ./kľ. bez spodnej rozety		18,00	21,60
kľ./kľ. + rozety BB		20,50	24,60
kľ./kľ. + rozety PZ		20,50	24,60
kľ./kľ. + rozety WC		28,00	33,60
kľ./kľ. + rozety WC s ukazovateľom		28,00	33,60
guľa/kľ. + rozety PZ		24,50	29,40

5
ROZETKY



KR



TR 4
200 tis.

MP - DANIELA - R

	Cena za set v €	bez DPH	s DPH
kľ./kľ. bez spodnej rozety		18,00	21,60
kľ./kľ. + rozety BB		20,50	24,60
kľ./kľ. + rozety PZ		20,50	24,60
kľ./kľ. + rozety WC		28,00	33,60
kľ./kľ. + rozety WC s ukazovateľom		28,00	33,60
guľa/kľ. + rozety PZ		24,50	29,40

5
ROZETKY



KR



TR 4
200 tis.

MATERIÁL: NEREZ

MATERIÁL: NEREZ



NEM NEREZ MATNÁ

TVAR PROFILU

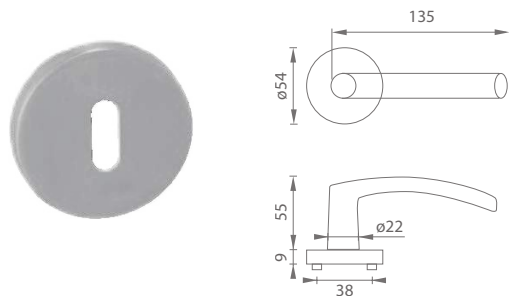

CIM ČIERNA MATNÁ (EB)

TVAR PROFILU

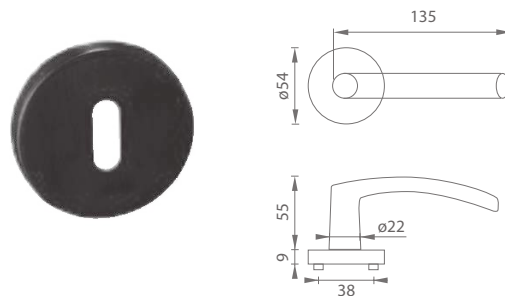

MP - ESSO - R

	Cena za set v €	bez DPH	s DPH
kľ./kľ. bez spodnej rozety		14,50	17,40
kľ./kľ. + rozety BB		17,00	20,40
kľ./kľ. + rozety PZ		17,00	20,40
kľ./kľ. + rozety WC		24,50	29,40
kľ./kľ. + rozety WC s ukazovateľom		24,50	29,40
guľa/kľ. + rozety PZ		23,00	27,60

OVERTE CENU

5



KR



TR 4

200 tis.

MP - ESSO - R

	Cena za set v €	bez DPH	s DPH
kľ./kľ. bez spodnej rozety		20,00	24,00
kľ./kľ. + rozety BB		23,50	28,20
kľ./kľ. + rozety PZ		23,50	28,20
kľ./kľ. + rozety WC		32,50	39,00
guľa/kľ. + rozety PZ		31,00	37,20

5



KR



TR 4

200 tis.





R BB

NEM NEREZ MATNÁ



R BB

CIM ČIERNÁ MATNÁ (EB)



R PZ



R WC



R PZ



R ZÁSLEPKA



R WC S UKAZOVATEĽOM



R WC

Farby v ukazovateli



R BB

R PZ

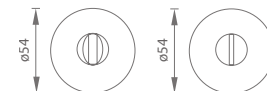

R WC

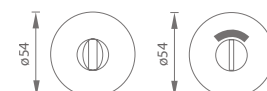

R WC S UKAZOVATEĽOM

MATERIÁL: NEREZ



MP - ROZETA - R

	Cena za pár v €	bez DPH	s DPH
rozety R bez otvoru - záslepka		2,50	3,00
rozety R BB		2,50	3,00
rozety R PZ		2,50	3,00
rozety R WC		10,00	12,00
rozety R WC s ukazovateľom		10,00	12,00

OVERTE CENU



MP - ROZETA - R

	Cena za pár v €	bez DPH	s DPH
rozety R BB		3,50	4,20
rozety R PZ		3,50	4,20
rozety R WC		12,50	15,00





NEM NEREZ MATNÁ

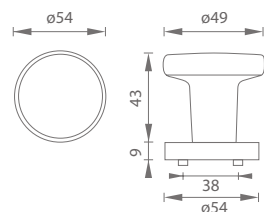

i Guľa použitá pri kľučkách na okrúhlej rozete (R) v prevedení guľa/kľučka



CIM ČIERNA MATNÁ (EB)

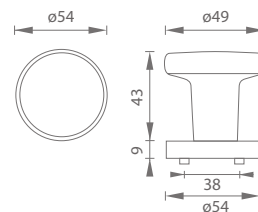

i Guľa použitá pri kľučkách na okrúhlej rozete (R) v prevedení guľa/kľučka



MP - GUĽA PEVNÁ - R

	Cena za kus v €	bez DPH	s DPH
guľa pevná - R (okrúhla rozeta)		13,00	15,60



OVERTE
CENU

MP - GUĽA PEVNÁ - R

	Cena za kus v €	bez DPH	s DPH
guľa pevná - R (okrúhla rozeta)		17,50	21,00



MATERIÁL: NEREZ

MATERIÁL: NEREZ

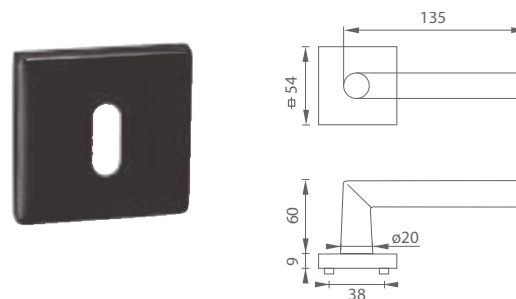
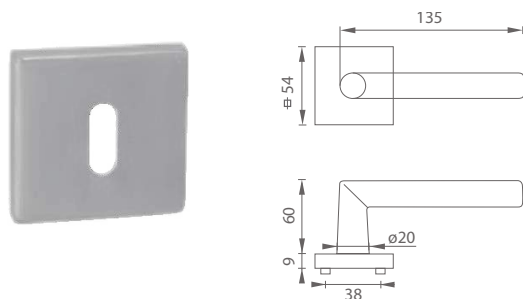
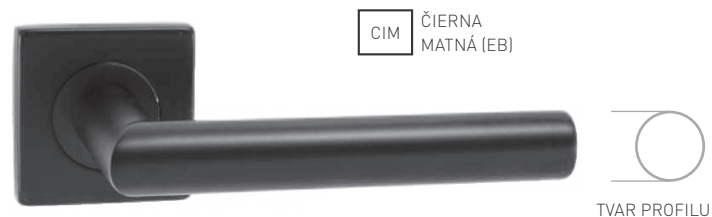
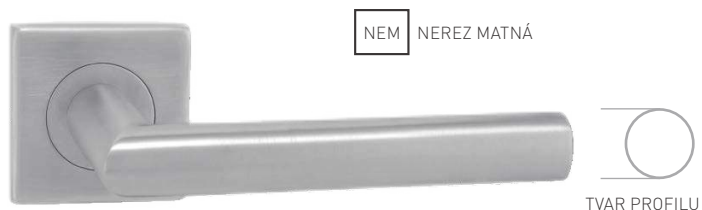

i Kľučka na eurookno na strane 268



MP - FAVORIT - HR

	Cena za set v €	bez DPH	s DPH
kľ./kľ. bez spodnej rozety		14,00	16,80
kľ./kľ. + rozety BB		17,00	20,40
kľ./kľ. + rozety PZ		17,00	20,40
kľ./kľ. + rozety WC		24,50	29,40
kľ./kľ. + rozety WC s ukazovateľom		24,50	29,40
guľa/kľ. + rozety PZ		24,50	29,40

OVERTE CENU

5
ROKOV GARANCIA



KR



TR 4
200 tis.

MP - FAVORIT - HR

	Cena za set v €	bez DPH	s DPH
kľ./kľ. bez spodnej rozety		20,00	24,00
kľ./kľ. + rozety BB		24,00	28,80
kľ./kľ. + rozety PZ		24,00	28,80
kľ./kľ. + rozety WC		33,00	39,60
guľa/kľ. + rozety PZ		33,00	39,60

5
ROKOV GARANCIA



KR



TR 4
200 tis.

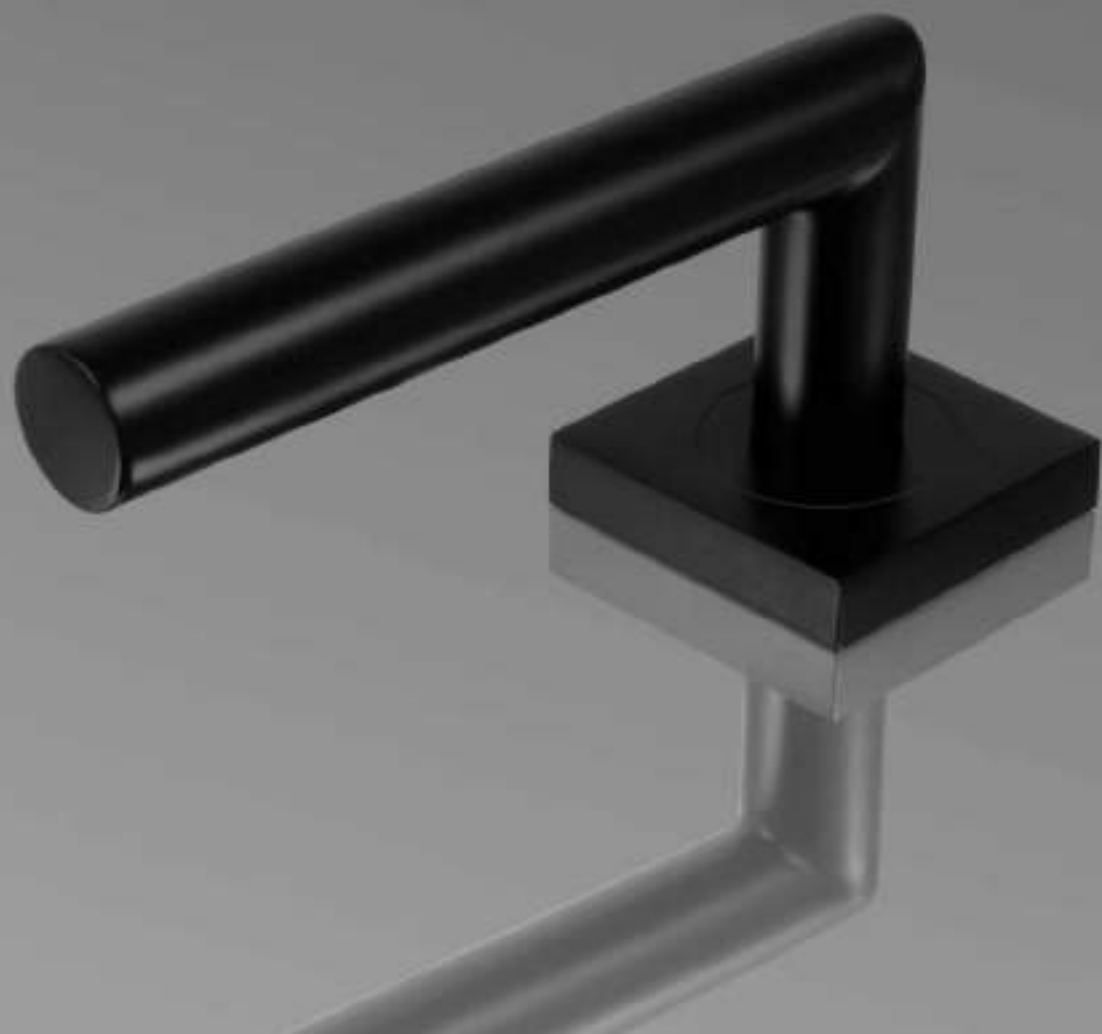

MATERIÁL: NEREZ



NEM NEREZ MATNÁ

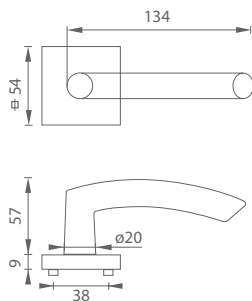

NEM NEREZ MATNÁ

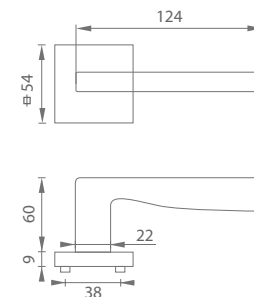

OVERTE
CENU

MP - NERO - HR

	Cena za set v €	bez DPH	s DPH
kľ./kľ. bez spodnej rozety		14,00	16,80
kľ./kľ. + rozety BB		17,00	20,40
kľ./kľ. + rozety PZ		17,00	20,40
kľ./kľ. + rozety WC		24,50	29,40
kľ./kľ. + rozety WC s ukazovateľom		24,50	29,40
guľa/kľ. + rozety PZ		24,50	29,40

5



KR



TR 4

200 tis.

MP - MODERNA - HR

	Cena za set v €	bez DPH	s DPH
kľ./kľ. bez spodnej rozety		20,00	24,00
kľ./kľ. + rozety BB		23,00	27,60
kľ./kľ. + rozety PZ		23,00	27,60
kľ./kľ. + rozety WC		30,50	36,60
kľ./kľ. + rozety WC s ukazovateľom		30,50	36,60
madlo/kľ. + rozety PZ		29,00	34,80

5



KR



TR 4

200 tis.



NEM NEREZ MATNÁ

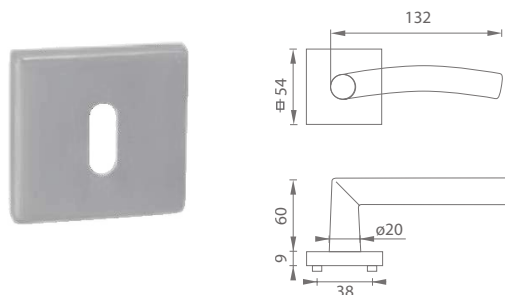

NEM NEREZ MATNÁ

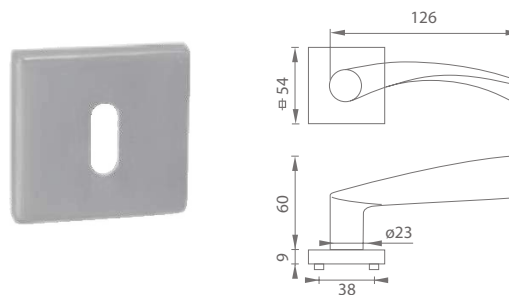

OVERTE
CENU

MP - SWING - HR

	Cena za set v €	bez DPH	s DPH
kľ./kľ. bez spodnej rozety		14,00	16,80
kľ./kľ. + rozety BB		17,00	20,40
kľ./kľ. + rozety PZ		17,00	20,40
kľ./kľ. + rozety WC		24,50	29,40
kľ./kľ. + rozety WC s ukazovateľom		24,50	29,40
guľa/kľ. + rozety PZ		24,50	29,40

5



MP - TORNADO - HR

	Cena za set v €	bez DPH	s DPH
kľ./kľ. bez spodnej rozety		20,00	24,00
kľ./kľ. + rozety BB		23,00	27,60
kľ./kľ. + rozety PZ		23,00	27,60
kľ./kľ. + rozety WC		30,50	36,60
kľ./kľ. + rozety WC s ukazovateľom		30,50	36,60
guľa/kľ. + rozety PZ		27,50	33,00

5



MATERIÁL: NEREZ

MATERIÁL: NEREZ

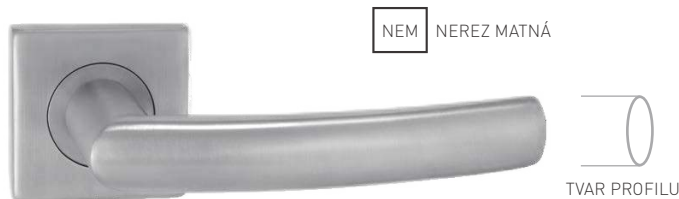

NEM NEREZ MATNÁ

TVAR PROFILU

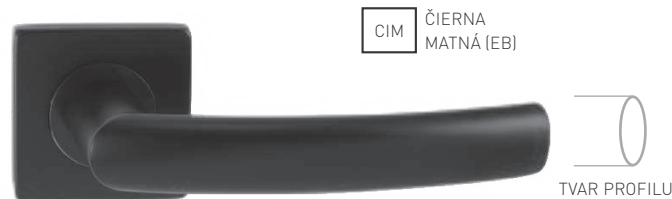
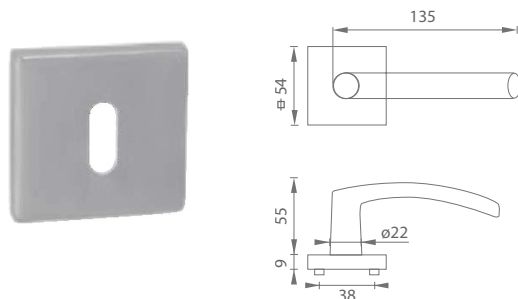

CIM ČIERNA MATNÁ (EB)

TVAR PROFILU

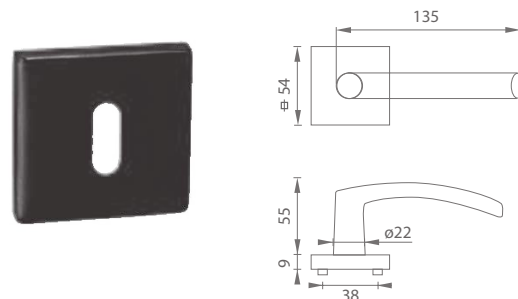

OVERTE
CENU

MP - ESSO - HR

	Cena za set v €	bez DPH	s DPH
kľ./kľ. bez spodnej rozety		18,00	21,60
kľ./kľ. + rozety BB		21,00	25,20
kľ./kľ. + rozety PZ		21,00	25,20
kľ./kľ. + rozety WC		28,50	34,20
kľ./kľ. + rozety WC s ukazovateľom		28,50	34,20
guľa/kľ. + rozety PZ		26,50	31,80

5
ROZETKY



TR 4
200 tis.

MP - ESSO - HR

	Cena za set v €	bez DPH	s DPH
kľ./kľ. bez spodnej rozety		22,00	26,40
kľ./kľ. + rozety BB		26,00	31,20
kľ./kľ. + rozety PZ		26,00	31,20
kľ./kľ. + rozety WC		35,00	42,00
guľa/kľ. + rozety PZ		34,00	40,80

5
ROZETKY



TR 4
200 tis.

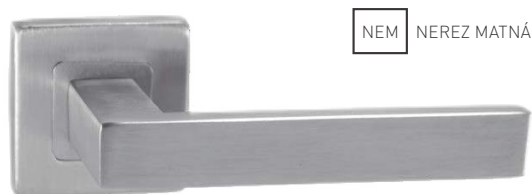

NEM NEREZ MATNÁ

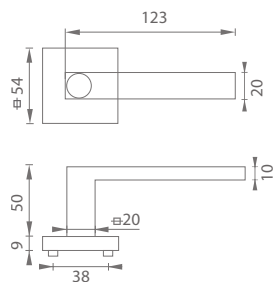

CIM ČIERNA MATNÁ (EB)

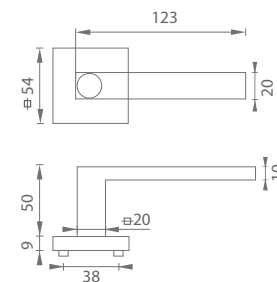

i Okenné kľučky na strane 269



OVERTE
CENU

MP - QUADRA - HR

	Cena za set v €	bez DPH	s DPH
kľ./kľ. bez spodnej rozety		20,00	24,00
kľ./kľ. + rozety BB		23,00	27,60
kľ./kľ. + rozety PZ		23,00	27,60
kľ./kľ. + rozety WC		30,50	36,60
kľ./kľ. + rozety WC s ukazovateľom		30,50	36,60
madlo/kľ. + rozety PZ		29,00	34,80

5



MP - QUADRA - HR

	Cena za set v €	bez DPH	s DPH
kľ./kľ. bez spodnej rozety		25,00	30,00
kľ./kľ. + rozety BB		29,00	34,80
kľ./kľ. + rozety PZ		29,00	34,80
kľ./kľ. + rozety WC		38,00	45,60
madlo/kľ. + rozety PZ		36,50	43,80

5



MATERIÁL: NEREZ

MATERIÁL: NEREZ



NEM NEREZ MATNÁ

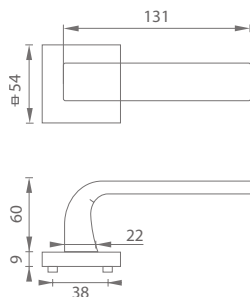

CIM ČIERNÁ MATNÁ (EB)

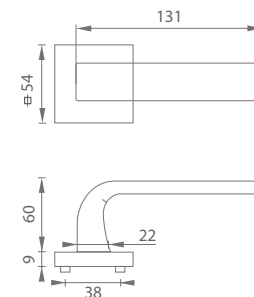

MP - SUNNY - HR

	Cena za set v €	bez DPH	s DPH
kľ./kľ. bez spodnej rozety		20,00	24,00
kľ./kľ. + rozety BB		23,00	27,60
kľ./kľ. + rozety PZ		23,00	27,60
kľ./kľ. + rozety WC		30,50	36,60
kľ./kľ. + rozety WC s ukazovateľom		30,50	36,60
madlo/kľ. + rozety PZ		29,00	34,80

5
ROZETKY



KR



TR 4
200 tis.

**OVERTE
CENU**

MP - SUNNY - HR

	Cena za set v €	bez DPH	s DPH
kľ./kľ. bez spodnej rozety		25,00	30,00
kľ./kľ. + rozety BB		29,00	34,80
kľ./kľ. + rozety PZ		29,00	34,80
kľ./kľ. + rozety WC		38,00	45,60
madlo/kľ. + rozety PZ		36,50	43,80

5
ROZETKY



KR



TR 4
200 tis.



NEM NEREZ MATNÁ

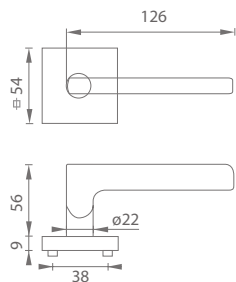

CIM ČIERNA MATNÁ (EB)

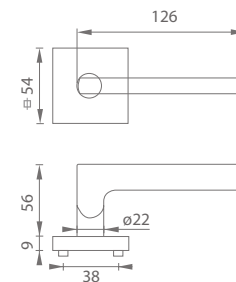

OVERTE
CENU

MP - DANIELA - HR

	Cena za set v €	bez DPH	s DPH
kľ./kľ. bez spodnej rozety		20,00	24,00
kľ./kľ. + rozety BB		23,00	27,60
kľ./kľ. + rozety PZ		23,00	27,60
kľ./kľ. + rozety WC		30,50	36,60
kľ./kľ. + rozety WC s ukazovateľom		30,50	36,60
guľa/kľ. + rozety PZ		27,50	33,00

5
ROZETKY



KR



TR 4
200 tis.

MP - DANIELA - HR

	Cena za set v €	bez DPH	s DPH
kľ./kľ. bez spodnej rozety		26,00	31,20
kľ./kľ. + rozety BB		30,00	36,00
kľ./kľ. + rozety PZ		30,00	36,00
kľ./kľ. + rozety WC		39,00	46,80
guľa/kľ. + rozety PZ		36,00	43,20

5
ROZETKY



KR



TR 4
200 tis.



NEM NEREZ MATNÁ

HR BB



HR PZ



HR WC



HR ZÁSLEPKA



HR WC S UKAZOVATELOM

Farby v ukazovateli



CIM ČIERNÁ MATNÁ (EB)

HR BB



HR PZ



HR WC

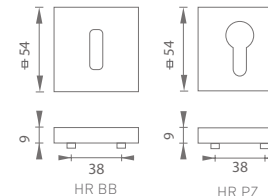

HR BB

HR PZ

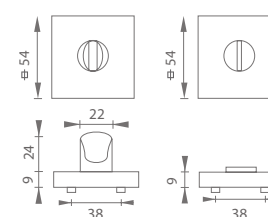

HR WC

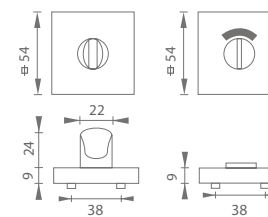

HR WC S UKAZOVATELOM

MATERIÁL: NEREZ



MP - ROZETA - HR

	Cena za pár v €	bez DPH	s DPH
rozety HR bez otvoru - záslepka		3,00	3,60
rozety HR BB		3,00	3,60
rozety HR PZ		3,00	3,60
rozety HR WC		10,50	12,60
rozety HR WC s ukazovateľom		10,50	12,60

OVERTE CENU



MP - ROZETA - HR

	Cena za pár v €	bez DPH	s DPH
rozety HR BB		4,00	4,80
rozety HR PZ		4,00	4,80
rozety HR WC		13,00	15,60





NEM NEREZ MATNÁ

CIM ČIERNÁ MATNÁ (EB)

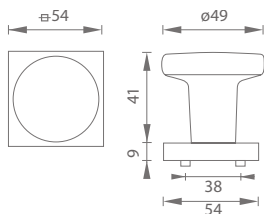

i Guľa použitá pri kľučkách na hranatej rozete (HR) v prevedení guľa/kľučka



NEM NEREZ MATNÁ

CIM ČIERNÁ MATNÁ (EB)

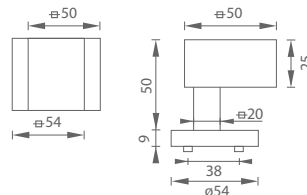

i Madlo použité pri kľučkách QUADRA - HR v prevedení madlo/kľučka



MP - GULA PEVNÁ - HR

	Cena za kus v €	bez DPH	s DPH
guľa pevná - HR (hranatá rozeta) NEM	14,50		17,40
guľa pevná - HR (hranatá rozeta) CIM	19,00		22,80

ÖVERTE
CENU



MP - MADLO PEVNÉ VYOSENÉ - HR

	Cena za kus v €	bez DPH	s DPH
madlo pevné - HR (hranatá rozeta) - NEM	16,00		19,20
madlo pevné - HR (hranatá rozeta) - CIM	20,00		24,00



MATERIÁL: NEREZ

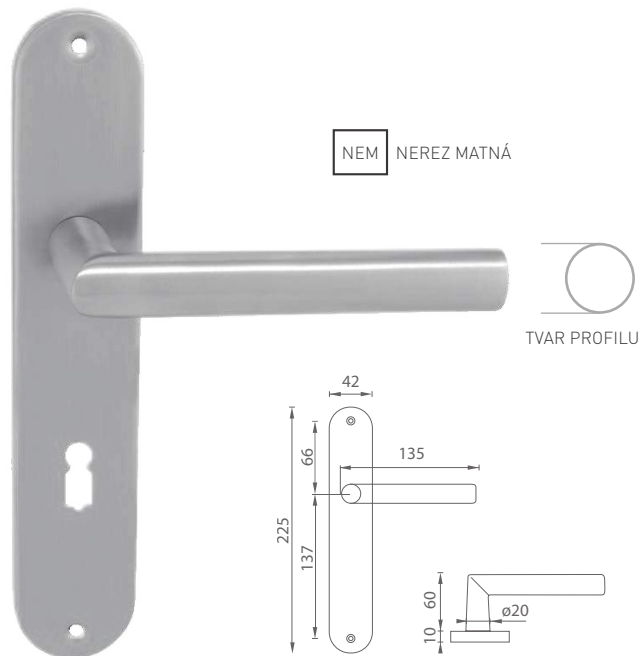

NEM NEREZ MATNÁ

TVAR PROFILU

i Otvor a rozteč vyrážame na objednávku podľa typu zámku

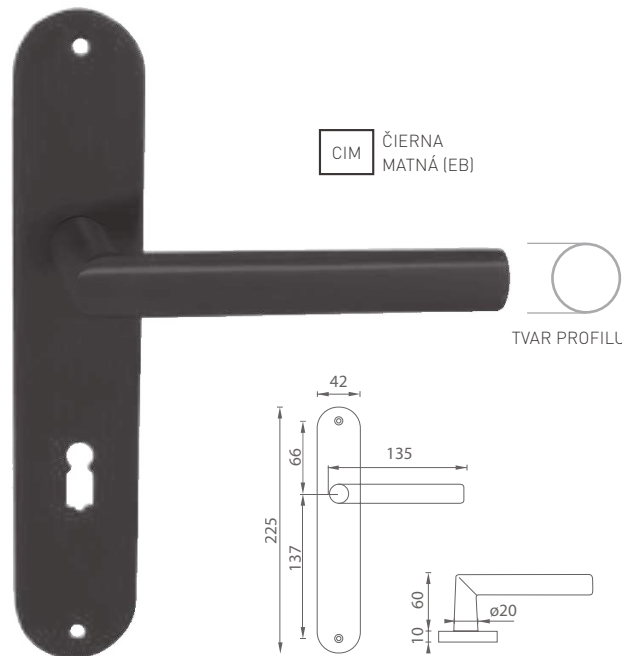

CIM ČIERNA MATNÁ (EB)

TVAR PROFILU

i Otvor a rozteč vyrážame na objednávku podľa typu zámku



OVERTE CENU

MP - FAVORIT - SO

	Cena za set v €	bez DPH	s DPH
kľ./kľ. bez otvoru		20,00	24,00
kľ./kľ. s BB otvorom pre kľúč		20,00	24,00
kľ./kľ. s PZ otvorom pre vložku		20,00	24,00
kľ./kľ. s WC kľúčom		28,00	33,60
guľa/kľ. s PZ otvorom pre vložku		27,00	32,40

5
ROKOV ZÁRUKA



72
90
ROZTEČ



TR 3

100 tis.

MP - FAVORIT - SO

	Cena za set v €	bez DPH	s DPH
kľ./kľ. bez otvoru		24,00	28,80
kľ./kľ. s BB otvorom pre kľúč		24,00	28,80
kľ./kľ. s PZ otvorom pre vložku		24,00	28,80
kľ./kľ. s WC kľúčom		33,00	39,60
guľa/kľ. s PZ otvorom pre vložku		32,00	38,40

5
ROKOV ZÁRUKA



72
90
ROZTEČ



TR 3

100 tis.

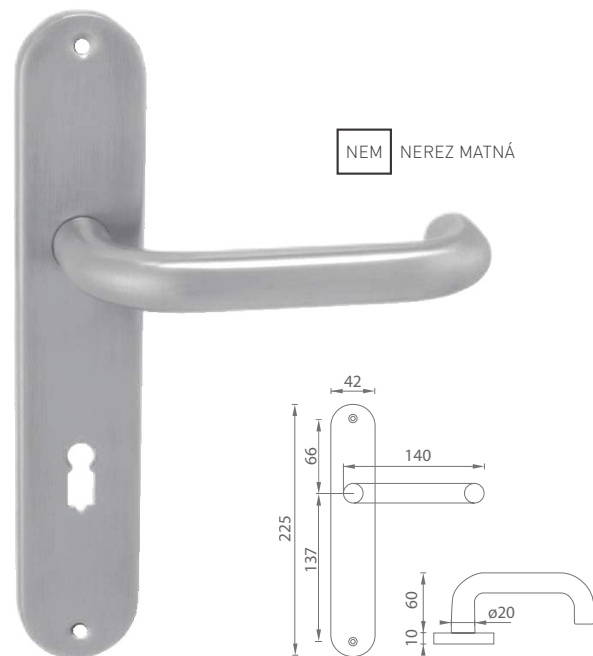

NEM NEREZ MATNÁ

i Otvor a rozteč vyrážame na objednávku podľa typu zámku

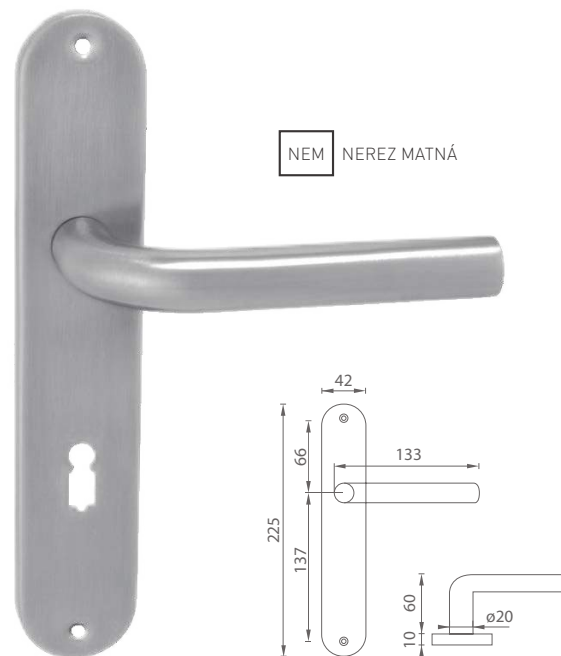

NEM NEREZ MATNÁ

i Otvor a rozteč vyrážame na objednávku podľa typu zámku

MATERIÁL: NEREZ



OVERTE
CENU

MP - COSLAN - SO

	Cena za set v €	bez DPH	s DPH
kľ./kľ. bez otvoru		20,00	24,00
kľ./kľ. s BB otvorom pre kľúč		20,00	24,00
kľ./kľ. s PZ otvorom pre vložku		20,00	24,00
kľ./kľ. s WC kľúčom		28,00	33,60
guľa/kľ. s PZ otvorom pre vložku		27,00	32,40

5
ROKOV ZÁRUKA



72
90
ROZTEČ



TR 3

100 tis.

MP - MONA - SO

	Cena za set v €	bez DPH	s DPH
kľ./kľ. bez otvoru		20,00	24,00
kľ./kľ. s BB otvorom pre kľúč		20,00	24,00
kľ./kľ. s PZ otvorom pre vložku		20,00	24,00
kľ./kľ. s WC kľúčom		28,00	33,60
guľa/kľ. s PZ otvorom pre vložku		27,00	32,40

5
ROKOV ZÁRUKA



72
90
ROZTEČ



TR 3

100 tis.

MATERIÁL: NEREZ

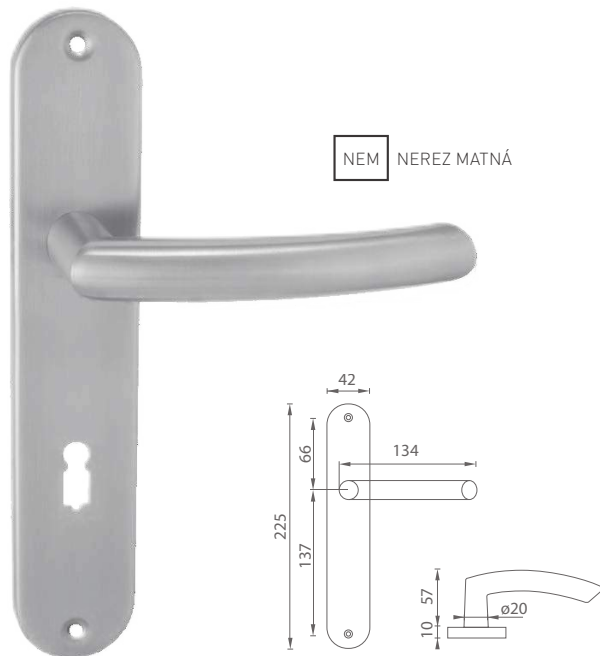

NEM NEREZ MATNÁ

i Otvor a rozteč vyrážame na objednávku podľa typu zámku

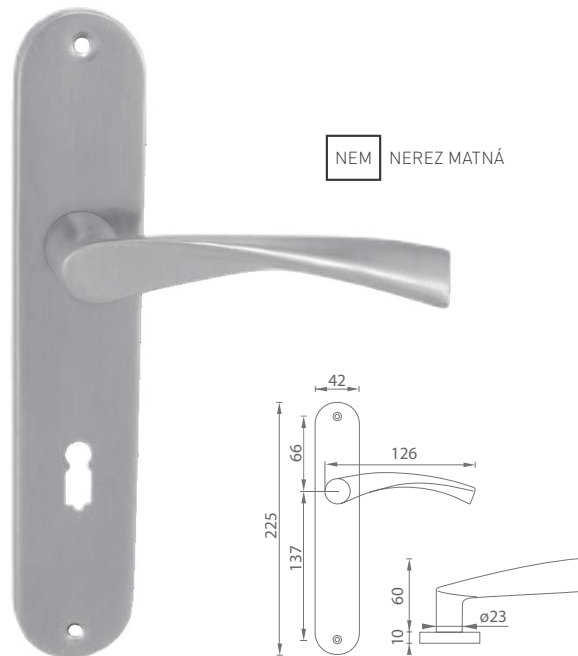

NEM NEREZ MATNÁ

i Otvor a rozteč vyrážame na objednávku podľa typu zámku



MP - NERO - SO

	Cena za set v €	bez DPH	s DPH
kľ./kľ. bez otvoru		20,00	24,00
kľ./kľ. s BB otvorom pre kľúč		20,00	24,00
kľ./kľ. s PZ otvorom pre vložku		20,00	24,00
kľ./kľ. s WC kľúčom		28,00	33,60
guľa/kľ. s PZ otvorom pre vložku		27,00	32,40

OVERTE CENU

5
ROKOV ZÁRUKA



TR 3
100 tis.

MP - TORNADO - SO

	Cena za set v €	bez DPH	s DPH
kľ./kľ. bez otvoru		25,00	30,00
kľ./kľ. s BB otvorom pre kľúč		25,00	30,00
kľ./kľ. s PZ otvorom pre vložku		25,00	30,00
kľ./kľ. s WC kľúčom		33,00	39,60
guľa/kľ. s PZ otvorom pre vložku		29,50	35,40

5
ROKOV ZÁRUKA



TR 3
100 tis.

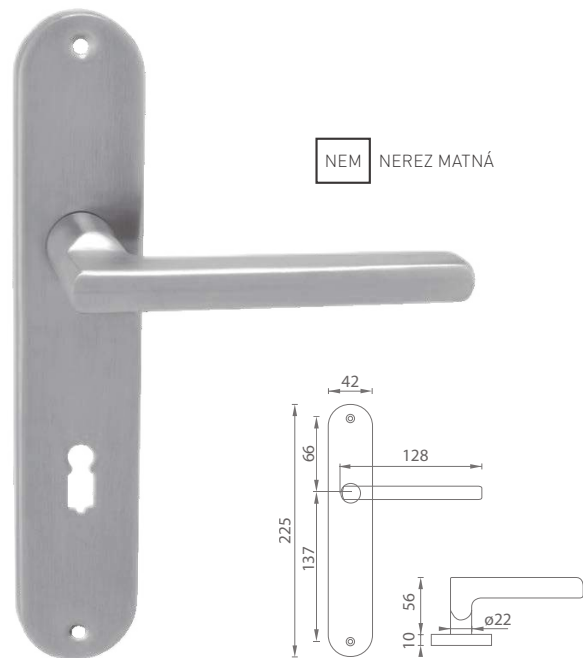

NEM NEREZ MATNÁ

i Otvor a rozteč vyrážame na objednávku podľa typu zámku

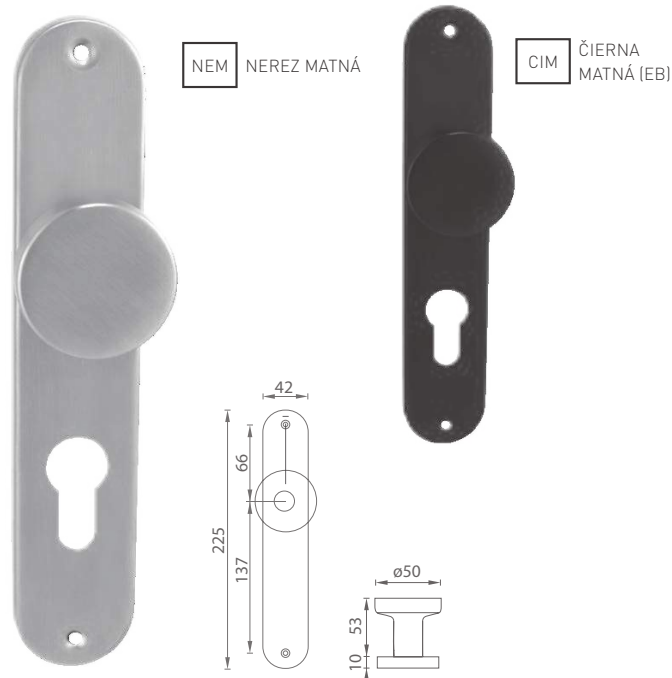

NEM NEREZ MATNÁ

CIM ČIERNÁ MATNÁ (EB)

i Guľa použitá pri kľúčoch na oválnom štíte (SO) v prevedení guľa/kľučka

MATERIÁL: NEREZ



OVERTE
CENU

MP - DANIELA - SO

	Cena za set v €	bez DPH	s DPH
kľ./kľ. bez otvoru		25,00	30,00
kľ./kľ. s BB otvorom pre kľúč		25,00	30,00
kľ./kľ. s PZ otvorom pre vložku		25,00	30,00
kľ./kľ. s WC kľúčom		33,00	39,60
guľa/kľ. s PZ otvorom pre vložku		29,50	35,40

5
ROKOV ZÁRUKA



72
90
ROZTEČ



TR 3
100 tis.

MP - GUĽA PEVNÁ - SO

	Cena za kus v €	bez DPH	s DPH
guľa na ovál. štíte bez otvoru NEM		17,00	20,40
guľa na ovál. štíte s PZ otvorom NEM		17,00	20,40
guľa na ovál. štíte bez otvoru CIM		20,00	24,00
guľa na ovál. štíte s PZ otvorom CIM		20,00	24,00

5
ROKOV ZÁRUKA



72
90
ROZTEČ



TR 3
100 tis.

MATERIÁL: NEREZ

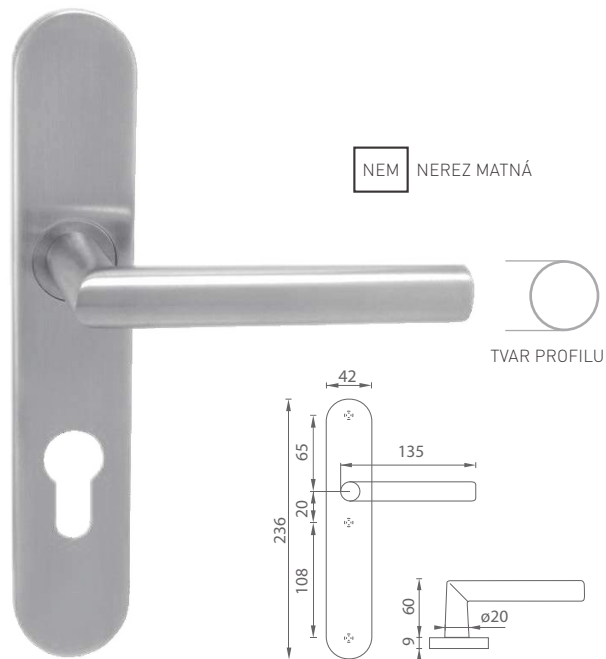

- i** Spevnené štíty majú prekryté skrutky
- i** Otvor a rozteč vyrážame na objednávku podľa typu zámku

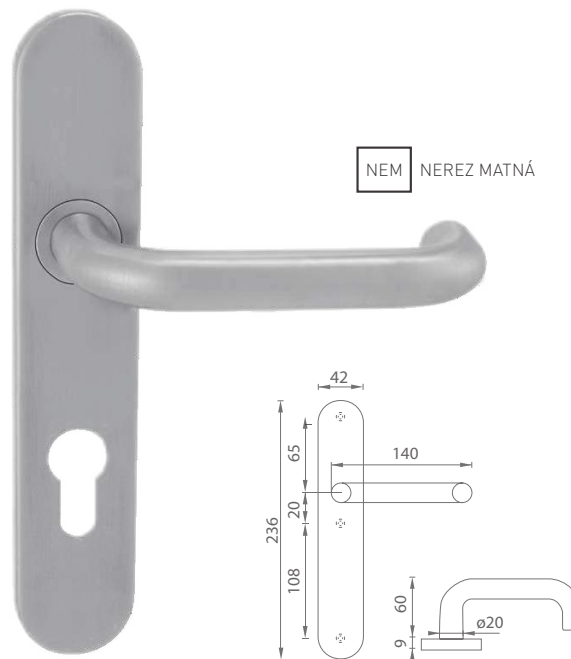

- i** Spevnené štíty majú prekryté skrutky
- i** Otvor a rozteč vyrážame na objednávku podľa typu zámku



MP - FAVORIT ŠPECIÁL - SO

	Cena za set v €	bez DPH	s DPH
kľ./kľ. bez otvoru		25,00	30,00
kľ./kľ. s BB otvorom pre kľúč		25,00	30,00
kľ./kľ. s PZ otvorom pre vložku		25,00	30,00
kľ./kľ. s WC kľúčom		33,00	39,60
guľa/kľ. s PZ otvorom pre vložku		32,50	39,00

OVERTE CENU

5
ROKOV ZÁRUKA



72
90
ROZTEČ



TR 3
100 tis.

MP - COSLAN ŠPECIÁL - SO

	Cena za set v €	bez DPH	s DPH
kľ./kľ. bez otvoru		25,00	30,00
kľ./kľ. s BB otvorom pre kľúč		25,00	30,00
kľ./kľ. s PZ otvorom pre vložku		25,00	30,00
kľ./kľ. s WC kľúčom		33,00	39,60
guľa/kľ. s PZ otvorom pre vložku		32,50	39,00

5
ROKOV ZÁRUKA



72
90
ROZTEČ



TR 3
100 tis.



NEM NEREZ MATNÁ

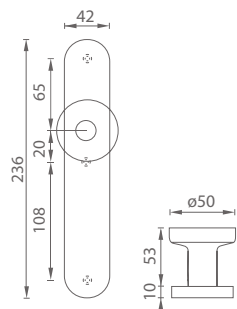

- i** Spevnené štíty majú prekryté skrutky
- i** Otvor a rozteč vyrážame na objednávku podľa typu zámku





KONŠTRUKCIA ŠTÍTOV
ŠPECIÁL

MATERIÁL: NEREZ



MP - GULA PEVNÁ ŠPECIÁL - SO

	Cena za kus v €	
	bez DPH	s DPH
guľa bez otvoru	20,00	24,00
guľa s PZ otvorom pre vložku  	20,00	24,00

5
ROKOV ZÁRUKA



72
90
ROZTEČ



TR 3
100 tis.

OVERTE
CENU

MATERIÁL: NEREZ

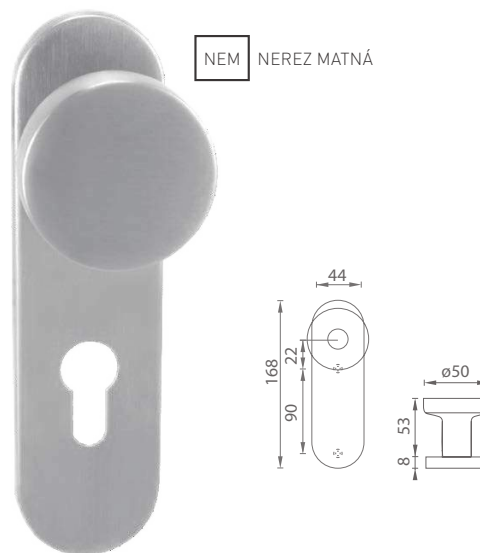
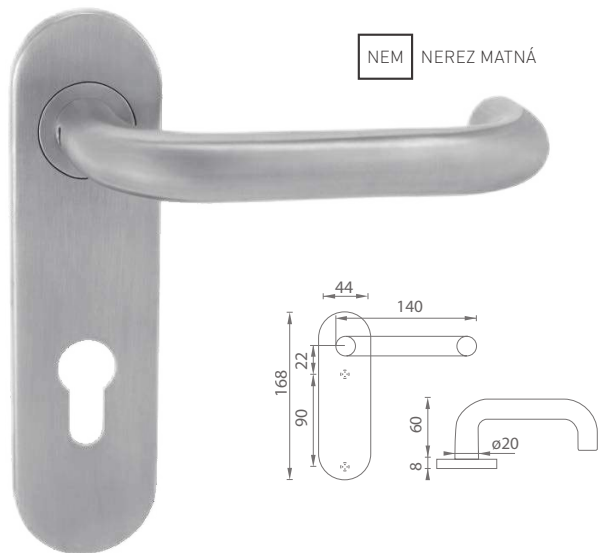





i Dostupné len v rozteči 72 mm

- i** Spevnené štíty majú prekryté skrutky
- i** Dostupné len v rozteči 72 mm



MP - COSLAN ŠPECIÁL - SOK

	Cena za kus v €	bez DPH	s DPH
kl./kl. bez otvoru		25,00	30,00
kl./kl. s PZ otvorom pre vložku	 	25,00	30,00
guľa/kl. s PZ otvorom pre vložku	 	31,00	37,20

OVERTE
CENU

5
ROKOV ZÁRUKA





72
ROZTEČ



TR 3
100 tis.

MP - GUĽA PEVNÁ ŠPECIÁL - SOK

	Cena za kus v €	bez DPH	s DPH
kl./kl. bez otvoru		20,00	24,00
guľa s PZ otvorom pre vložku	 	20,00	24,00

5
ROKOV ZÁRUKA



72
ROZTEČ



TR 3
100 tis.

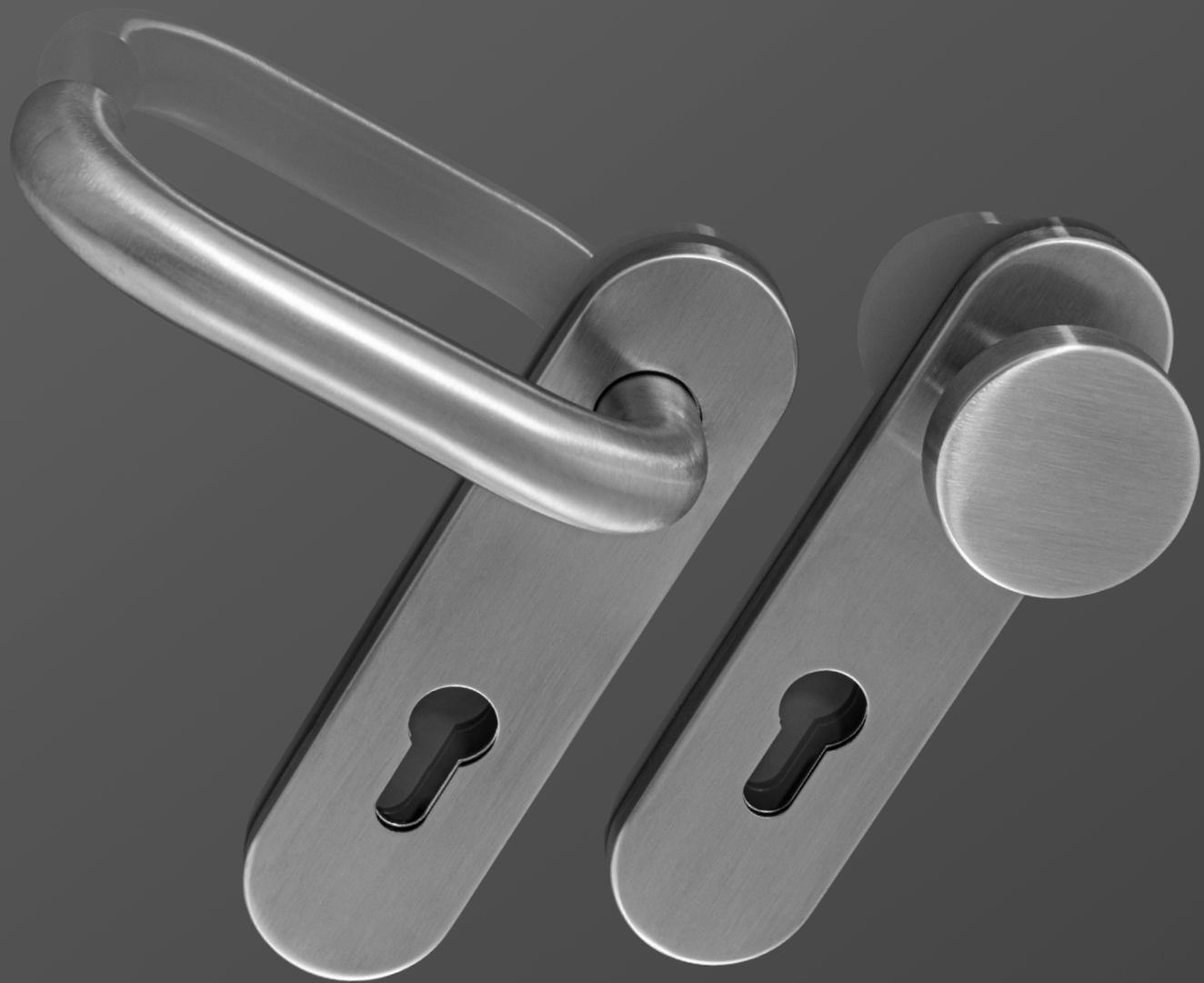

MATERIÁL: NEREZ

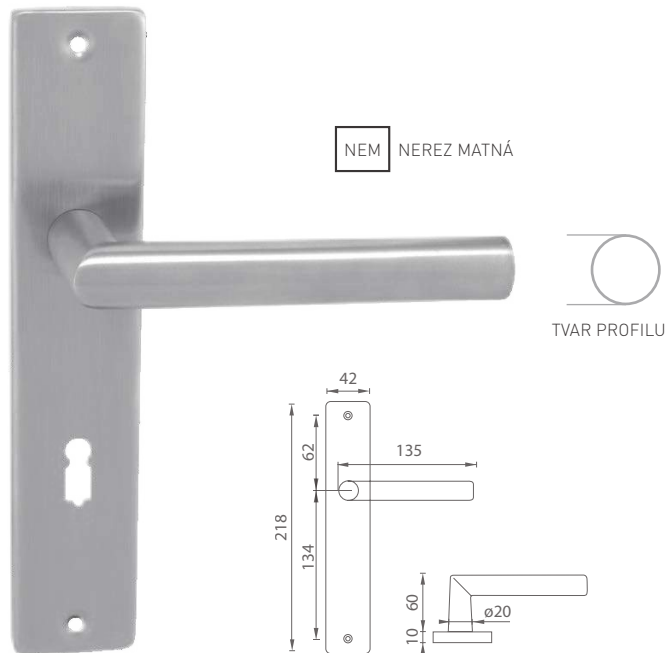

NEM NEREZ MATNÁ



i Otvor a rozteč vyrábame na objednávku podľa typu zámku

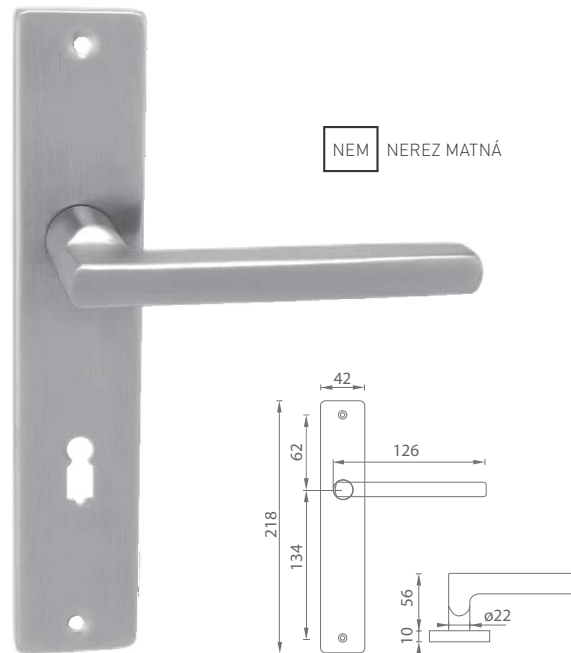

NEM NEREZ MATNÁ

i Otvor a rozteč vyrábame na objednávku podľa typu zámku



MP - FAVORIT - SH

	Cena za set v €	bez DPH	s DPH
kľ./kľ. bez otvoru		20,00	24,00
kľ./kľ. s BB otvorom pre kľúč		20,00	24,00
kľ./kľ. s PZ otvorom pre vložku		20,00	24,00
kľ./kľ. s WC kľúčom		28,00	33,60
guľa/kľ. s PZ otvorom pre vložku		27,00	32,40

OVERTE CENU

5
ROKOV ZÁRUKA



72
90
ROZTEČ



TR 3
100 tis.

MP - DANIELA - SH

	Cena za set v €	bez DPH	s DPH
kľ./kľ. bez otvoru		23,00	27,60
kľ./kľ. s BB otvorom pre kľúč		23,00	27,60
kľ./kľ. s PZ otvorom pre vložku		23,00	27,60
kľ./kľ. s WC kľúčom		31,00	37,20
guľa/kľ. s PZ otvorom pre vložku		28,50	34,20

5
ROKOV ZÁRUKA



72
90
ROZTEČ



TR 3
100 tis.

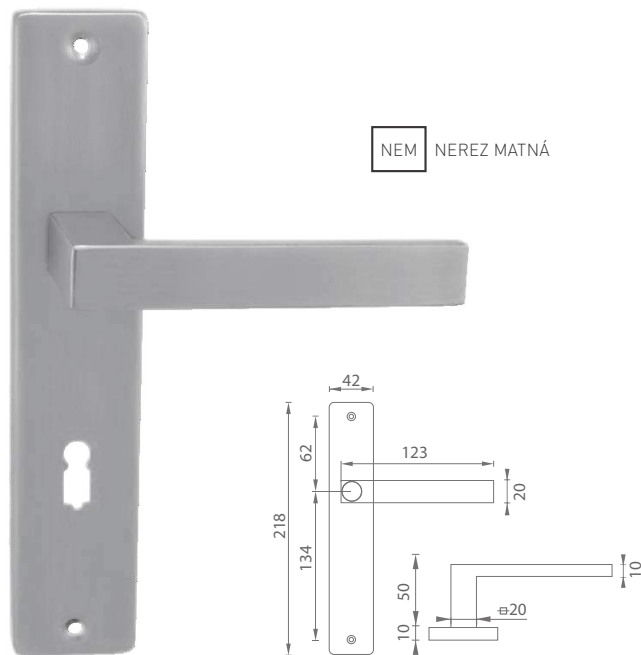

NEM NEREZ MATNÁ

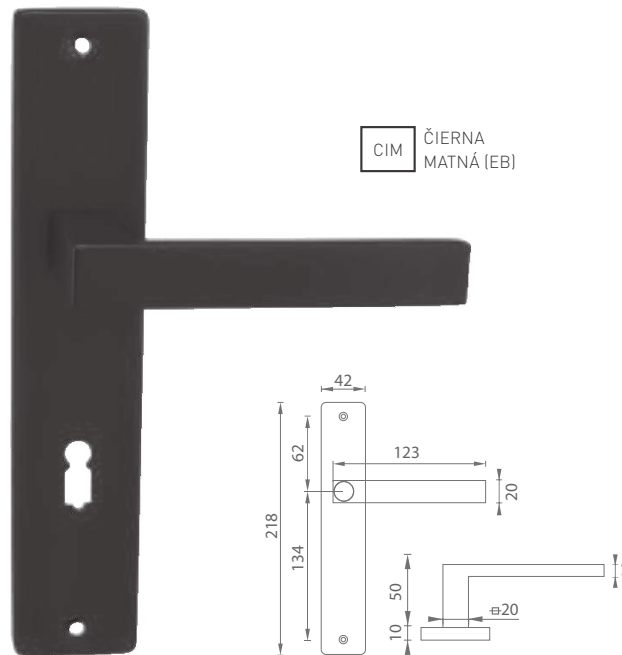

CIM ČIERNÁ MATNÁ (EB)

i Otvor a rozteč vyrážame na objednávku podľa typu zámku

i Otvor a rozteč vyrážame na objednávku podľa typu zámku

MATERIÁL: NEREZ



OVERTE
CENU

MP - QUADRA - SH

	Cena za set v €	bez DPH	s DPH
kľ./kľ. bez otvoru		23,00	27,60
kľ./kľ. s BB otvorom pre kľúč		23,00	27,60
kľ./kľ. s PZ otvorom pre vložku		23,00	27,60
kľ./kľ. s WC kľúčom		31,00	37,20
guľa/kľ. + rozety PZ		30,50	36,60
madlo/kľ. s PZ otvorom pre vložku		30,50	36,60

5
ROKOV ZÁRUKA



72
90
ROZTEČ



TR 3

100 tis.

MP - QUADRA - SH

	Cena za set v €	bez DPH	s DPH
kľ./kľ. bez otvoru		27,00	32,40
kľ./kľ. s BB otvorom pre kľúč		27,00	32,40
kľ./kľ. s PZ otvorom pre vložku		27,00	32,40
kľ./kľ. s WC kľúčom		36,00	43,20
madlo/kľ. s PZ otvorom pre vložku		35,50	42,60

5
ROKOV ZÁRUKA



72
90
ROZTEČ



TR 3

100 tis.

MATERIÁL: NEREZ



NEM NEREZ MATNÁ

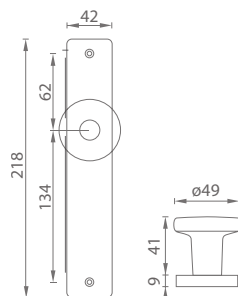

i Guľa použitá pri kľúčkoch na hranatom štíte (SH) v prevedení guľa/kľučka



NEM NEREZ MATNÁ

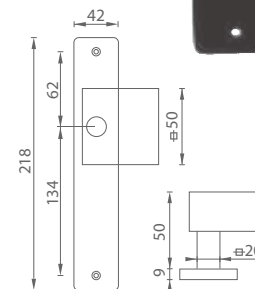



i Madlo použité pri kľúčkoch QUADRA - SH v prevedení madlo/kľučka



CIM ČIERNAMATNÁ (EB)



MP - GULĀ PEVNĀ - SH

	Cena za kus v €	bez DPH	s DPH
guľa na hranatom štíte bez otvoru	17,00	17,00	20,40
guľa na hran. štíte s PZ otvorom  	17,00	17,00	20,40

OVERTE CENU

5
ROKOV ZÁRUKA







72
90
ROZETEC



TR 3
100 tis.

MP - MADLO PEVNĀ VYOSENĀ - SH

	Cena za kus v €	bez DPH	s DPH
madlo na hran. štíte bez otvoru NEM	19,00	19,00	22,80
madlo na hran. štíte s PZ otvorom NEM  	19,00	19,00	22,80
madlo na hran. štíte bez otvoru CIM	22,00	22,00	26,40
madlo na hran. štíte s PZ otvorom CIM  	22,00	22,00	26,40

5
ROKOV ZÁRUKA



72
90
ROZETEC



TR 3
100 tis.



MATERIÁL: NEREZ

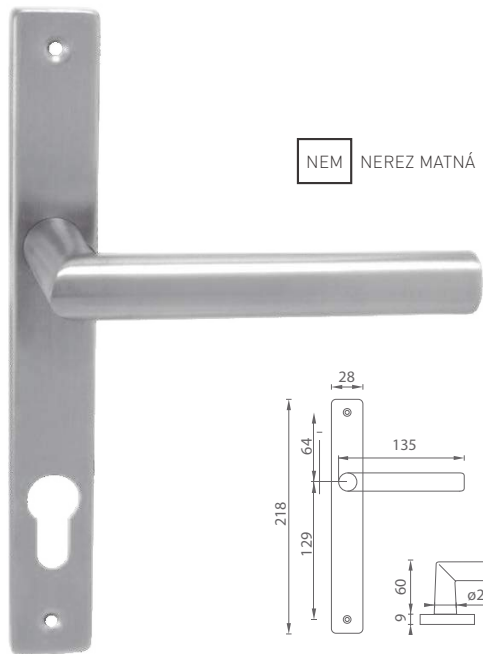

NEM NEREZ MATNÁ

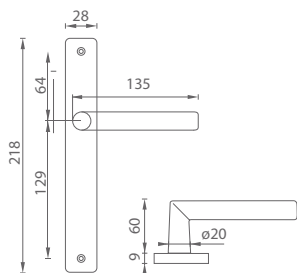

i Otvor a rozteč vyrážame na objednávku podľa typu zámku

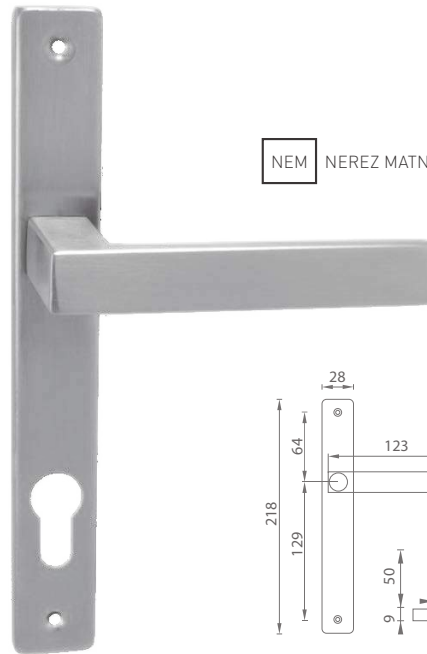

NEM NEREZ MATNÁ

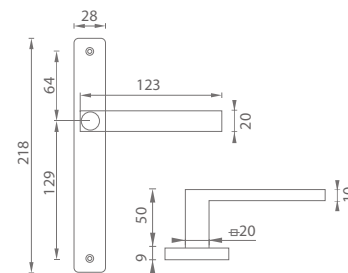

i Otvor a rozteč vyrážame na objednávku podľa typu zámku



MP - FAVORIT - SHU

	Cena za set v €	bez DPH	s DPH
kľ./kľ. bez otvoru		19,00	22,80
kľ./kľ. s BB otvorom pre kľúč		19,00	22,80
kľ./kľ. s PZ otvorom pre vložku		19,00	22,80
kľ./kľ. s WC kľúčom		27,00	32,40
madlo/kľ. s PZ otvorom pre vložku		26,50	31,80

OVERTE CENU



MP - QUADRA - SHU

	Cena za set v €	bez DPH	s DPH
kľ./kľ. bez otvoru		23,00	27,60
kľ./kľ. s BB otvorom pre kľúč		23,00	27,60
kľ./kľ. s PZ otvorom pre vložku		23,00	27,60
kľ./kľ. s WC kľúčom		31,00	37,20
madlo/kľ. s PZ otvorom pre vložku		28,50	34,20





NEM NEREZ MATNÁ

PRE ÚZKE PROFILY

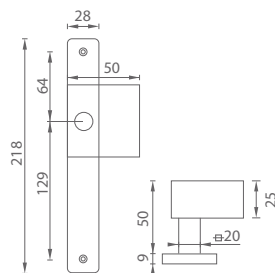

Vysokokvalitná nerez, zúžený dizajn roziet a štítov v kombinácii s kľučkou, guľou alebo madlom - komplexná ponuka kovaní pre profilové dvere s úzkym rámom, záhradné bránky a bráničky.



i Madlo použité pri kľučkách na úzkom štíte (SHU) v prevedení madlo/kľučka



MP - MADLO PEVNÉ VYOSENÉ - SHU

	Cena za kus v €	bez DPH	s DPH
madlo na SHU bez otvoru		17,00	20,40
madlo na SHU s PZ otvorom	 	17,00	20,40

5
ROKOV ZÁRUKA



72
90
ROZETEC



TR 3
100 tis.

OVERTE
CENU

MATERIÁL: NEREZ

MATERIÁL: NEREZ



NEM NEREZ MATNÁ

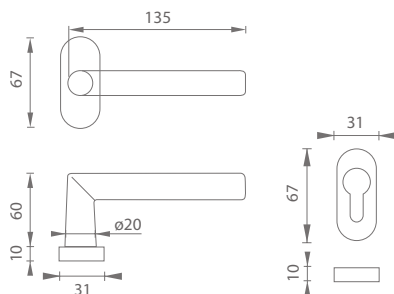

CIM ČIERNA MATNÁ (EB)

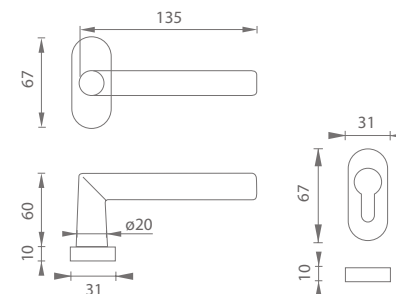

MP - FAVORIT - UOR

	Cena za set v €	bez DPH	s DPH
kl./kl. + rozety PZ	16,00	16,00	19,20
guľa/kl. + rozety PZ	22,50	22,50	27,00

OVERTE
CENU



200 tis.

MP - FAVORIT - UOR

	Cena za set v €	bez DPH	s DPH
kl./kl. + rozety PZ	23,00	23,00	27,60
guľa/kl. + rozety PZ	29,50	29,50	35,40



200 tis.



NEM NEREZ MATNÁ

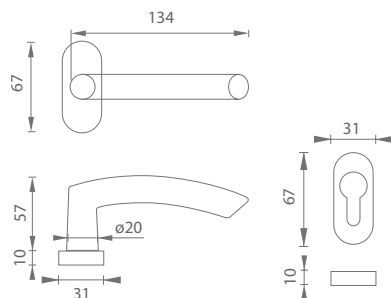

CIM ČIERNA MATNÁ (EB)

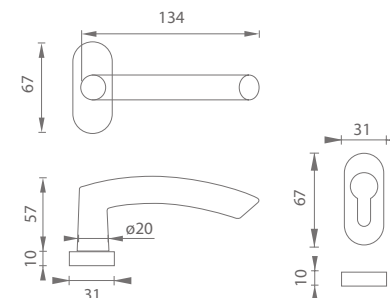

MATERIÁL: NEREZ



MP - NERO - UOR

	Cena za set v €		bez DPH	s DPH
kl./kl. + rozety PZ			16,00	19,20
guľa/kl. + rozety PZ			22,50	27,00



200 tis.

OVERTE
CENU

MP - NERO - UOR

	Cena za set v €		bez DPH	s DPH
kl./kl. + rozety PZ			23,00	27,60
guľa/kl. + rozety PZ			29,50	35,40



200 tis.

MATERIÁL: NEREZ



NEM NEREZ MATNÁ

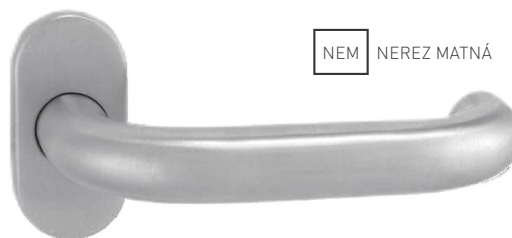
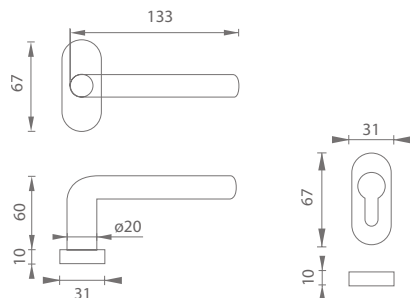

NEM NEREZ MATNÁ

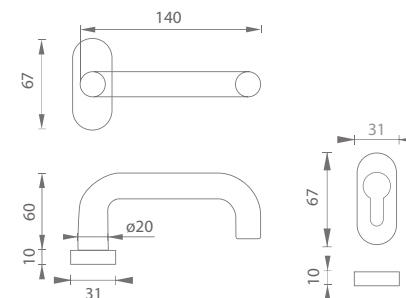

MP - MONA - UOR

	Cena za set v €		bez DPH	s DPH
kl./kl. + rozety PZ			16,00	19,20
guľa/kl. + rozety PZ			22,50	27,00



MP - COSLAN - UOR

	Cena za set v €		bez DPH	s DPH
kl./kl. + rozety PZ			16,00	19,20
guľa/kl. + rozety PZ			22,50	27,00



OVERTE
CENU



OUR PZ

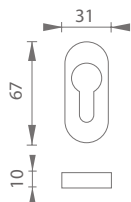

UOR PZ

NEM NEREZ MATNÁ



UOR PZ

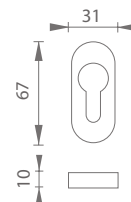

UOR PZ

CIM ČIERNA MATNÁ (EB)



UOR ZÁSLEPKA

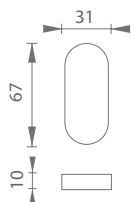

UOR ZÁSLEPKA



MP - ROZETA - UOR

	Cena za pár v €	bez DPH	s DPH
rozety UOR PZ	☰ ☱	2,50	3,00
rozety UOR bez otvoru - záslepka		2,50	3,00



MP - ROZETA - UOR

	Cena za pár v €	bez DPH	s DPH
rozety UOR PZ	☰ ☱	3,50	4,20



OVERTE
CENU

MATERIÁL: NEREZ

MATERIÁL: NEREZ



NEM NEREZ MATNÁ

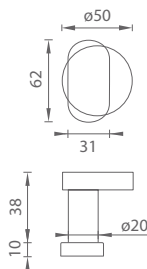

CIM ČIERNA MATNÁ (EB)

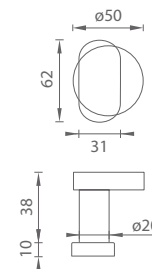

MP - GUĽA VYOSENÁ PEVNÁ PLOCHÁ - UOR

	Cena za kus v €	bez DPH	s DPH
guľa vyosená pevná kus		12,00	14,40



OVERTE
CENU

MP - GUĽA VYOSENÁ PEVNÁ PLOCHÁ - UOR

	Cena za kus v €	bez DPH	s DPH
guľa vyosená pevná kus		15,00	18,00









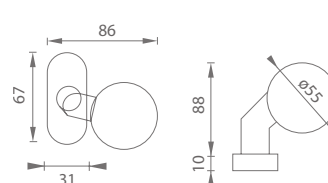
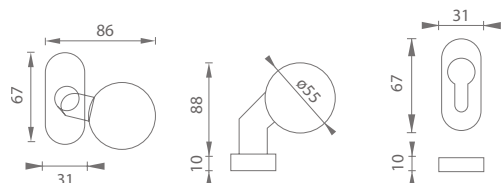

NEM NEREZ MATNÁ



NEM NEREZ MATNÁ



MP - GUĽA VYOSENÁ - UOR

		Cena za set v €	bez DPH	s DPH
guľa otočná/otočná + PZ rozety	 		28,50	34,20
guľa pevná/pevná + PZ rozety	 		28,50	34,20
guľa pevná/otočná + PZ rozety	 		28,50	34,20



MP - GUĽA PEVNÁ VYOSENÁ - UOR

	Cena za kus v €	bez DPH	s DPH
vyošená guľa pevná kus		13,00	15,60



OVERTE
CENU

MATERIÁL: NEREZ

MATERIÁL: NEREZ







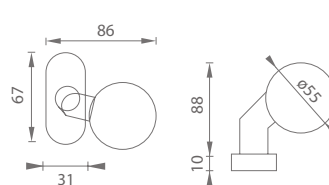
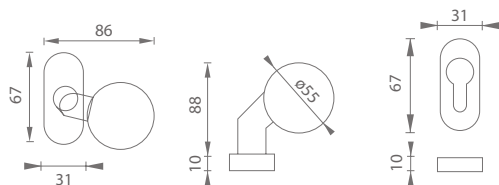

CIM ČIERNÁ
MATNÁ (EB)



CIM ČIERNÁ
MATNÁ (EB)



MP - GUĽA VYOSENÁ - UOR

	Cena za set v €	bez DPH	s DPH
guľa otočná/otočná + PZ rozety	 	35,50	42,60
guľa pevná/pevná + PZ rozety	 	35,50	42,60
guľa pevná/otočná + PZ rozety	 	35,50	42,60

OVERTE
CENU



MP - GUĽA PEVNÁ VYOSENÁ - UOR

	Cena za kus v €	bez DPH	s DPH
vyošená guľa pevná kus		16,00	19,20





MPK®

KLUČKY NA DVERE

séria **3SM**

Rozetové nerezové kľučky
s 3 mm magnetickou rozetou

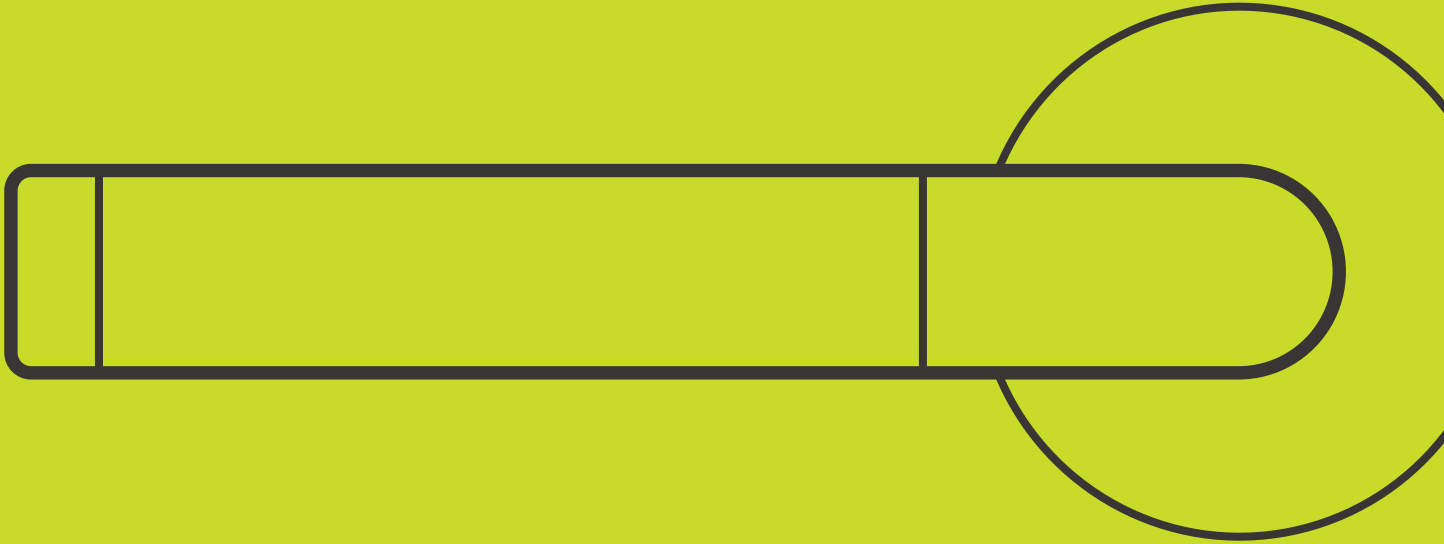

MPK[®]

3SM

ROZETOVÉ NEREZOVÉ
KLUČKY S 3 mm
MAGNETICKOU ROZETOU



KONŠTRUKCIA KĽUČIEK



VYSVETLIVKY



predĺžená záruka 5 rokov



súčasťou balenia je sada skrutiek na preskrutkovanie cez dvere



kovová rozeta



obsahuje vratný mechanizmus kľučky - pružinu



rozeta s výstupkami (zabraňuje nežiadanému pohybu rozety na dverách)



magnetická konštrukcia pre pevné priľnutie roziet

NEM NEREZ MATNÁ

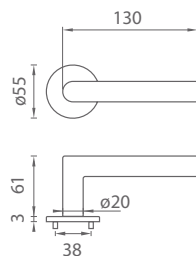

CIM PVD ČIERNÁ MATNÁ PVD (SB)

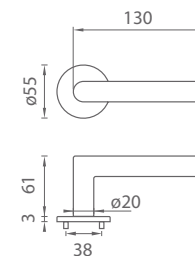

MATERIÁL: NEREZ

i CIM PVD - záruka na povrch 30 rokov



MP - FAVORIT - R 3SM

	Cena za set v €	bez DPH	s DPH
kľ./kľ. bez spodnej rozety		20,00	24,00
kľ./kľ. + rozety BB		26,00	31,20
kľ./kľ. + rozety PZ		26,00	31,20
kľ./kľ. + rozety WC		34,00	40,80
guľa/kľ. + rozety PZ		28,50	34,20



OVERTE CENU

MP - FAVORIT - R 3SM

	Cena za set v €	bez DPH	s DPH
kľ./kľ. bez spodnej rozety		28,00	33,60
kľ./kľ. + rozety BB		37,00	44,40
kľ./kľ. + rozety PZ		37,00	44,40
kľ./kľ. + rozety WC		47,00	56,40
guľa/kľ. + rozety PZ		41,00	49,20



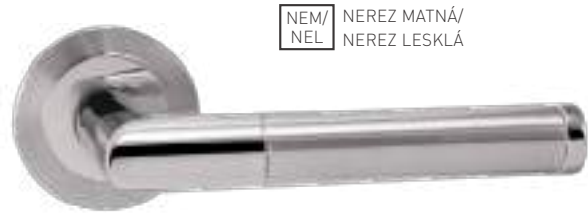

NEM/ NERAZ MATNÁ/
NEL NERAZ LESKLÁ

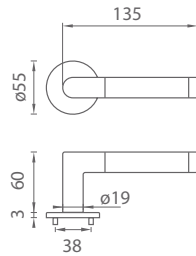

NEM/ NERAZ MATNÁ/
NEL NERAZ LESKLÁ

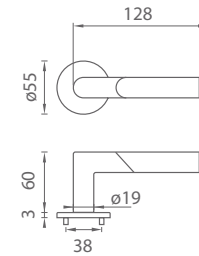

OVERTE
CENU

MP - PRADO - R 3SM

	Cena za set v €	bez DPH	s DPH
kľ./kľ. bez spodnej rozety		26,00	31,20
kľ./kľ. + rozety BB		35,00	42,00
kľ./kľ. + rozety PZ		35,00	42,00
kľ./kľ. + rozety WC		44,00	52,80
guľa/kľ. + rozety PZ		37,00	44,40



MP - MARENA - R 3SM

	Cena za set v €	bez DPH	s DPH
kľ./kľ. bez spodnej rozety		36,00	43,20
kľ./kľ. + rozety BB		45,00	54,00
kľ./kľ. + rozety PZ		45,00	54,00
kľ./kľ. + rozety WC		54,00	64,80
guľa/kľ. + rozety PZ		42,00	50,40



MATERIÁL: NERAZ

MATERIÁL: NEREZ

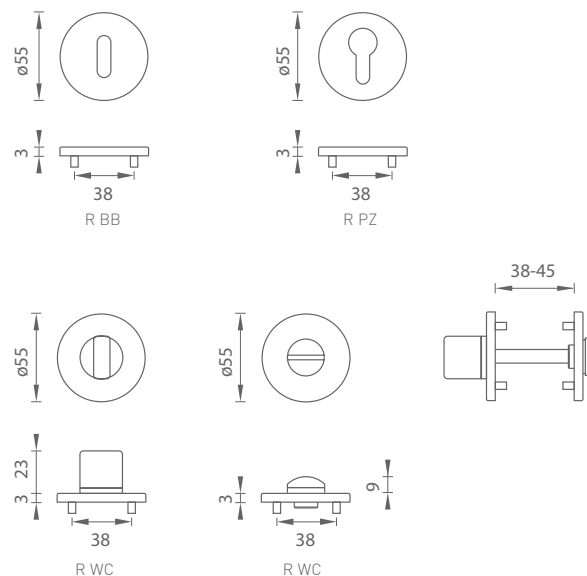
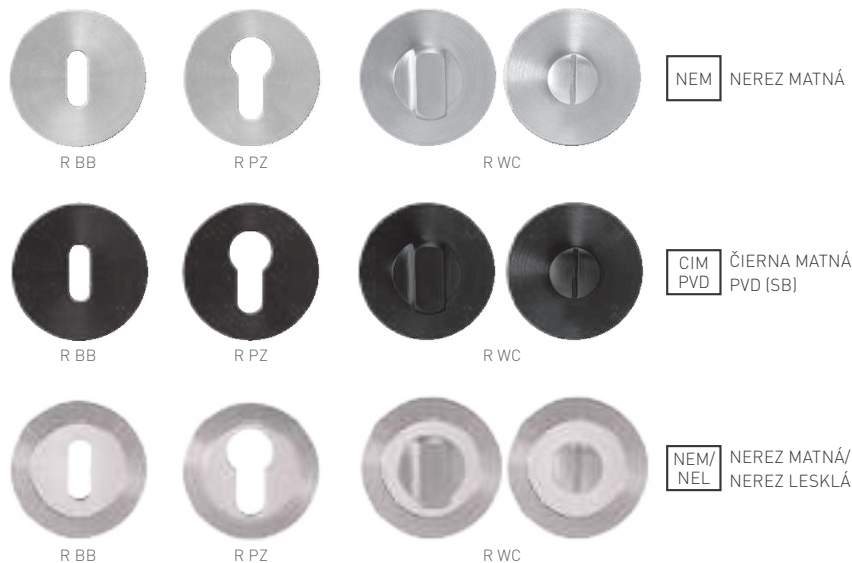

i CIM PVD - záruka na povrch 30 rokov



MP - ROZETA - R 3SM

Cena za pár v €	NEM		NEM/NEL		CIM PVD	
	bez DPH	s DPH	bez DPH	s DPH	bez DPH	s DPH
rozety R 3SM BB	6,00	7,20	9,00	10,80	9,00	10,80
rozety R 3SM PZ	6,00	7,20	9,00	10,80	9,00	10,80
rozety R 3SM WC	14,00	16,80	18,00	21,60	19,00	22,80



OVERTE
CENU



NEM NEREZ MATNÁ



CIM PVD ČIERNA MATNÁ PVD (SB)



NEM/ NEL NEREZ MATNÁ/ NEREZ LESKLÁ

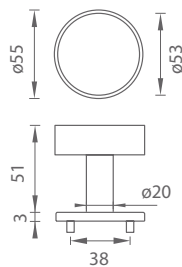

i CIM PVD - záruka na povrch 30 rokov



MP - GULĀ PEVNĀ - R 3SM

Cena za kus v €	NEM		NEM/NEL		CIM PVD	
	bez DPH	s DPH	bez DPH	s DPH	bez DPH	s DPH
guľa pevná R 3SM	12,50	15,00	15,00	18,00	18,00	21,60

OVERTE
CENU

5
ROKOV ZÁRUKA



KR



MATERIÁL: NEREZ

MATERIÁL: NEREZ



NEM NEREZ MATNÁ

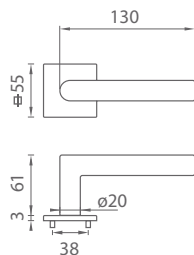

CIM PVD ČIERNA MATNÁ PVD (SB)

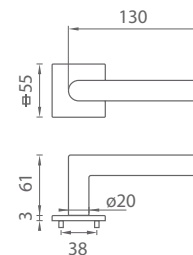
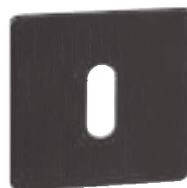

i CIM PVD - záruka na povrch 30 rokov



MP - FAVORIT - HR 3SM

	Cena za set v €	bez DPH	s DPH
kľ./kľ. bez spodnej rozety		20,00	24,00
kľ./kľ. + rozety BB		26,00	31,20
kľ./kľ. + rozety PZ		26,00	31,20
kľ./kľ. + rozety WC		34,00	40,80
madlo/kľ. + rozety PZ		29,00	34,80

OVERTE CENU



MP - FAVORIT - HR 3SM

	Cena za set v €	bez DPH	s DPH
kľ./kľ. bez spodnej rozety		30,00	36,00
kľ./kľ. + rozety BB		39,00	46,80
kľ./kľ. + rozety PZ		39,00	46,80
kľ./kľ. + rozety WC		49,00	58,80
madlo/kľ. + rozety PZ		42,50	51,00



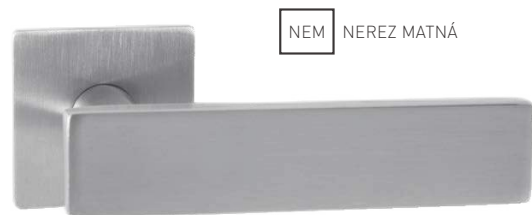

NEM NEREZ MATNÁ

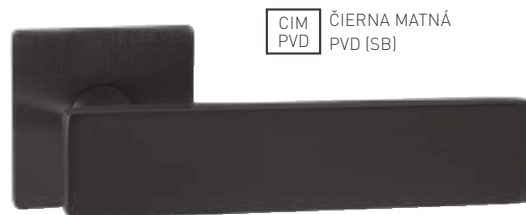
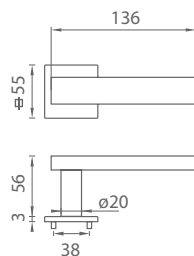

CIM PVD ČIERNA MATNÁ PVD (SB)

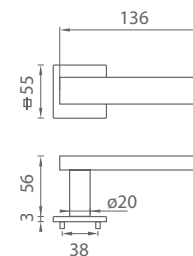
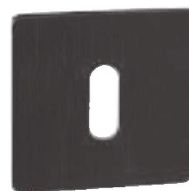

i CIM PVD - záruka na povrch 30 rokov

MATERIÁL: NEREZ



OVERTE
CENU

MP - APOLO - HR 3SM

	Cena za set v €	bez DPH	s DPH
kľ./kľ. bez spodnej rozety		24,00	28,80
kľ./kľ. + rozety BB		30,00	36,00
kľ./kľ. + rozety PZ		30,00	36,00
kľ./kľ. + rozety WC		38,00	45,60
madlo/kľ. + rozety PZ		31,00	37,20



MP - APOLO - HR 3SM

	Cena za set v €	bez DPH	s DPH
kľ./kľ. bez spodnej rozety		32,00	38,40
kľ./kľ. + rozety BB		41,00	49,20
kľ./kľ. + rozety PZ		41,00	49,20
kľ./kľ. + rozety WC		51,00	61,20
madlo/kľ. + rozety PZ		43,50	52,20



MATERIÁL: NEREZ



NEM NEREZ MATNÁ



CIM PVD ČIERNÁ MATNÁ PVD (SB)

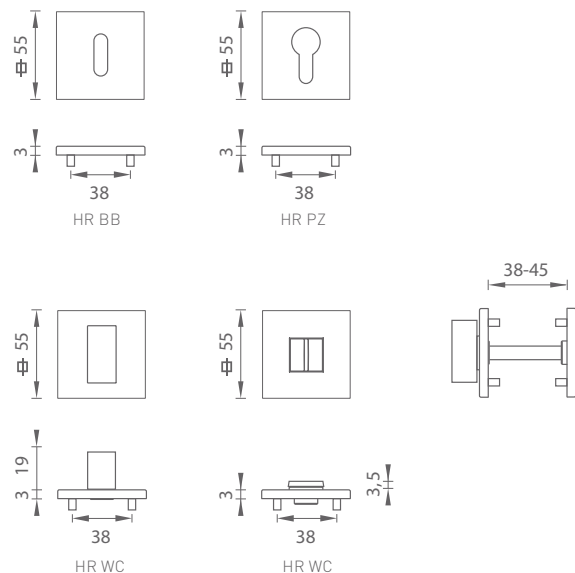

i CIM PVD - záruka na povrch 30 rokov



MP - ROZETA - HR 3SM	Cena za pár v €	NEM		CIM PVD	
		bez DPH	s DPH	bez DPH	s DPH
rozety HR 3SM BB		6,00	7,20	9,00	10,80
rozety HR 3SM PZ		6,00	7,20	9,00	10,80
rozety HR 3SM WC 6x6		14,00	16,80	19,00	22,80

OVERTE
CENU





NEM NEREZ MATNÁ



CIM PVD ČIERNÁ MATNÁ PVD (SB)

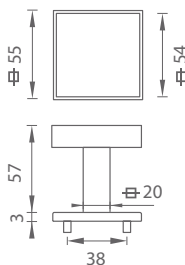

i CIM PVD - záruka na povrch 30 rokov



MP - MADLO PEVNÉ - HR 3SM

	NEM		CIM PVD	
	bez DPH	s DPH	bez DPH	s DPH
madlo pevné 3SM	13,00	15,60	18,50	22,20

5
ROKOV ZÁRUKA



KR

OVERTE
CENU

MATERIÁL: NEREZ

MPK®

KLUČKY NA DVERE

séria **S6**

Rozetové kľučky s 6 mm rozetou



MPK®

S6

ROZETOVÉ KLUČKY
S 6 mm ROZETOU

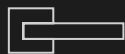

KONŠTRUKCIA KĽUČIEK



VYSVETLIVKY



predĺžená záruka 3 roky



obsahuje vratný mechanizmus kľučky - pružinu



rozeta s výstupkami (zabraňuje nežiadanému pohybu rozety na dverách)



súčasťou balenia je sada skrutiek na preskrutkovanie cez dvere



krytka rozety je ukotvená skrutkou (červíkom)



kovová rozeta

MATERIÁL: ZAMAK/HLINÍK



NIM NIKEL
MATNÝ (MSN)

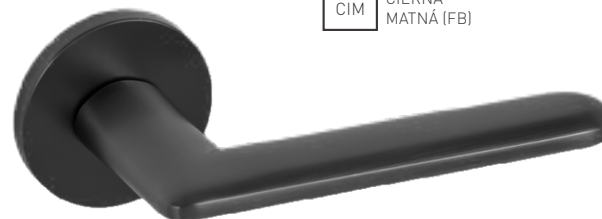
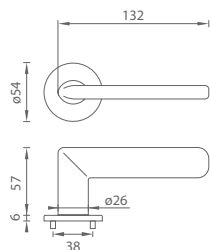

CIM ČIERN
MATNÁ (FB)

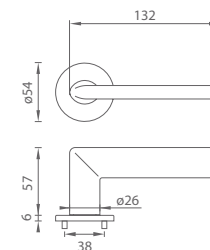

i Kľučka na eurookno na strane 270



MP - ELIPTICA - R S6

	Cena za set v €	bez DPH	s DPH
kľ./kľ. bez spodnej rozety		20,00	24,00
kľ./kľ. + rozety BB	 	28,00	33,60
kľ./kľ. + rozety PZ	 	28,00	33,60
kľ./kľ. + rozety WC	 	33,00	39,60
guľa/kľ. + rozety PZ	 	33,00	39,60

OVERTE
CENU

3
ROBY ZARUKA



KR



NIM NIKEL
MATNÝ (MSN)



CIM ČIERNA
MATNÁ (FB)

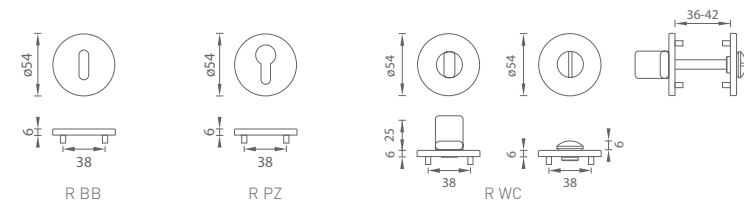

NIM NIKEL
MATNÝ (MSN)



CIM ČIERNA
MATNÁ (FB)

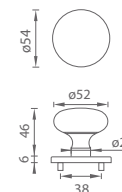

MATERIÁL: ZAMAK/HLINÍK



MP - ROZETA - R S6

	Cena za pár v €	bez DPH	s DPH
rozety R S6 BB	8,00	8,00	9,60
rozety R S6 PZ	8,00	8,00	9,60
rozety R S6 WC 6x6	13,00	13,00	15,60

OVERTE
CENU

3
ROKY ZÁRUKA



KR

MP - GUĽA PEVNÁ - R S6

	Cena za kus v €	bez DPH	s DPH
guľa pevná R S6	15,00	15,00	18,00

3
ROKY ZÁRUKA



KR

MATERIÁL: ZAMAK/HLINÍK



NIM NIKEL
MATNÝ (MSN)

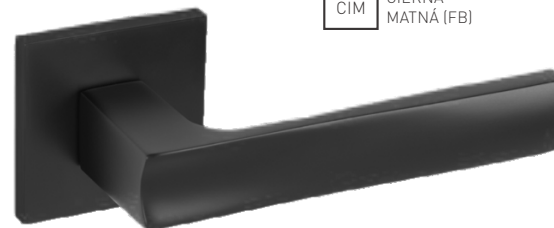
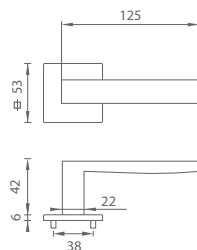

CIM ČIERNÁ
MATNÁ (FB)

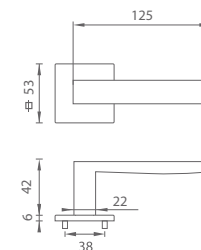

i Kľučka na eurookno na strane 272



MP - HOLLY - HR SQ6

	Cena za set v €	bez DPH	s DPH
kľ./kľ. bez spodnej rozety		20,00	24,00
kľ./kľ. + rozety BBQ		28,00	33,60
kľ./kľ. + rozety PZ		28,00	33,60
kľ./kľ. + rozety WC		33,00	39,60
madlo/kľ. + rozety PZ		33,00	39,60

**OVERTE
CENU**

3
ROKY ZÁRUKA



KR

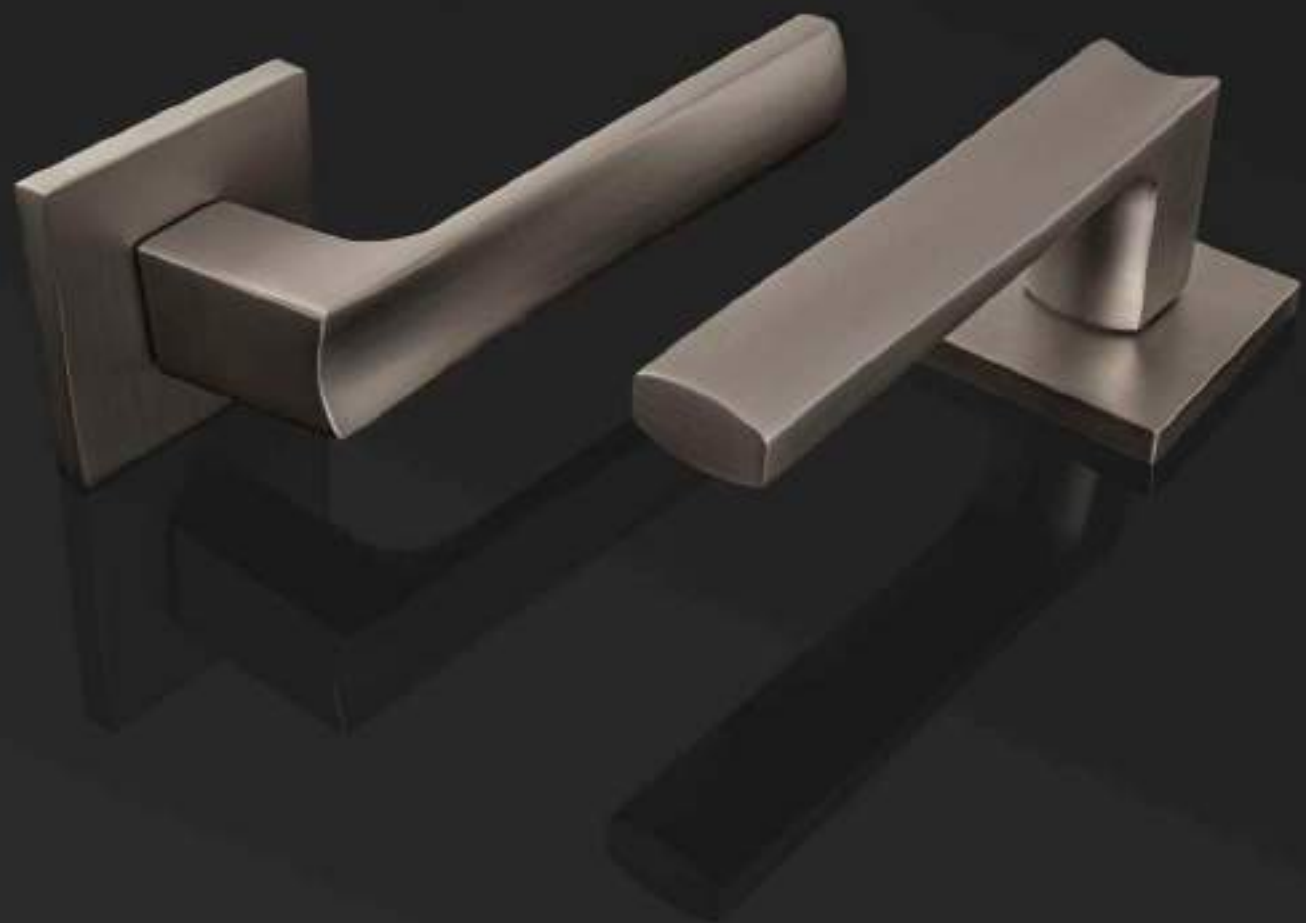

MATERIÁL: ZAMAK/HLINÍK

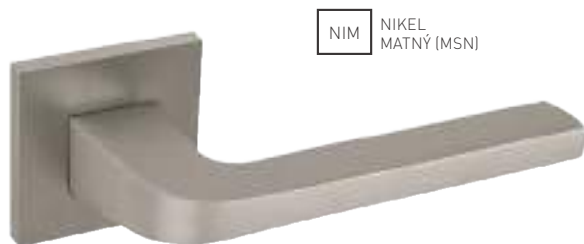

NIM NIKEL
MATNÝ (MSN)

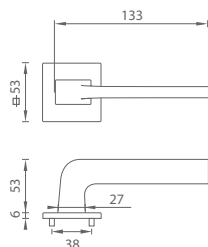

CIM ČIERNÁ
MATNÁ (FB)

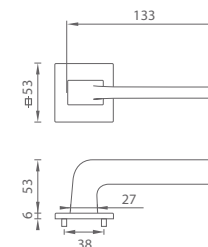

i Kľučka na eurookno na strane 274



MP - VIVA - HR SQ6

	Cena za set v €	bez DPH	s DPH
kľ./kľ. bez spodnej rozety		20,00	24,00
kľ./kľ. + rozety BBQ		28,00	33,60
kľ./kľ. + rozety PZ		28,00	33,60
kľ./kľ. + rozety WC		33,00	39,60
madlo/kľ. + rozety PZ		33,00	39,60

**OVERTE
CENU**

3
ROKY ZÁRUKA



KR



MATERIÁL: ZAMAK/HLINÍK

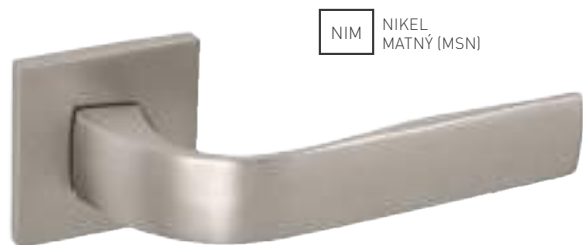

NIM NIKEL
MATNÝ (MSN)

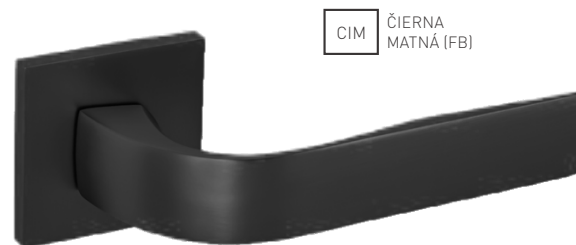

CIM ČIERN
MATNÁ (FB)

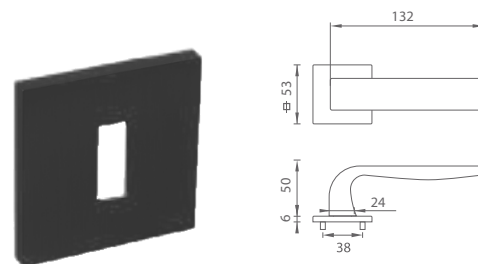
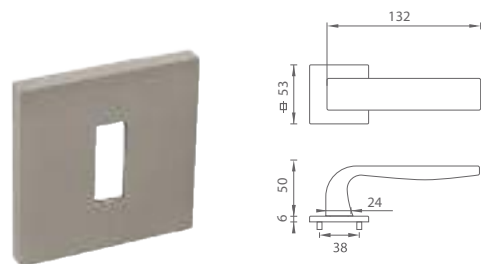

i Kľučka na eurookno na strane 273



MP - CYNTHIA - HR SQ6

	Cena za set v €	bez DPH	s DPH
kľ./kľ. bez spodnej rozety		20,00	24,00
kľ./kľ. + rozety BBQ		28,00	33,60
kľ./kľ. + rozety PZ		28,00	33,60
kľ./kľ. + rozety WC		33,00	39,60
madlo/kľ. + rozety PZ		33,00	39,60

**OVERTE
CENU**

3
ROKY ZÁRUKA



KR



MATERIÁL: ZAMAK/HLINÍK

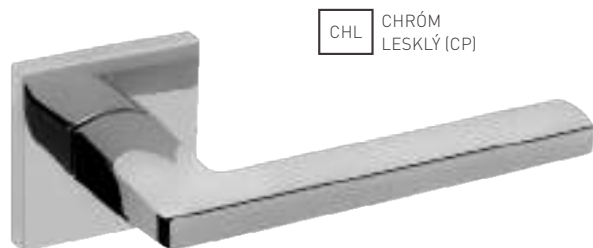

CHL CHRÓM
LESKLÝ (CP)

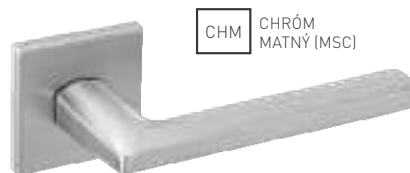

CHM CHRÓM
MATNÝ (MSC)

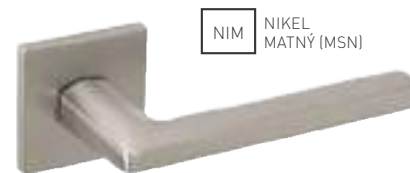

NIM NIKEL
MATNÝ (MSN)



GRM GRAFIT
MATNÝ (MSB)



CIM ČIERNA
MATNÁ (FB)

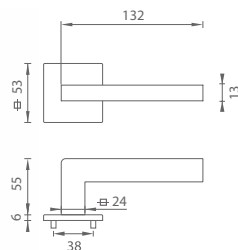

i Kľučka na eurookno na strane 275



MP - PRIMA - HR SQ6

	Cena za set v €	bez DPH	s DPH
kľ./kľ. bez spodnej rozety		20,00	24,00
kľ./kľ. + rozety BBQ		28,00	33,60
kľ./kľ. + rozety PZ		28,00	33,60
kľ./kľ. + rozety WC		33,00	39,60
madlo/kľ. + rozety PZ		33,00	39,60

**OVERTE
CENU**

3
ROKY ZÁRUKA

ROKY ZÁRUKA



KR

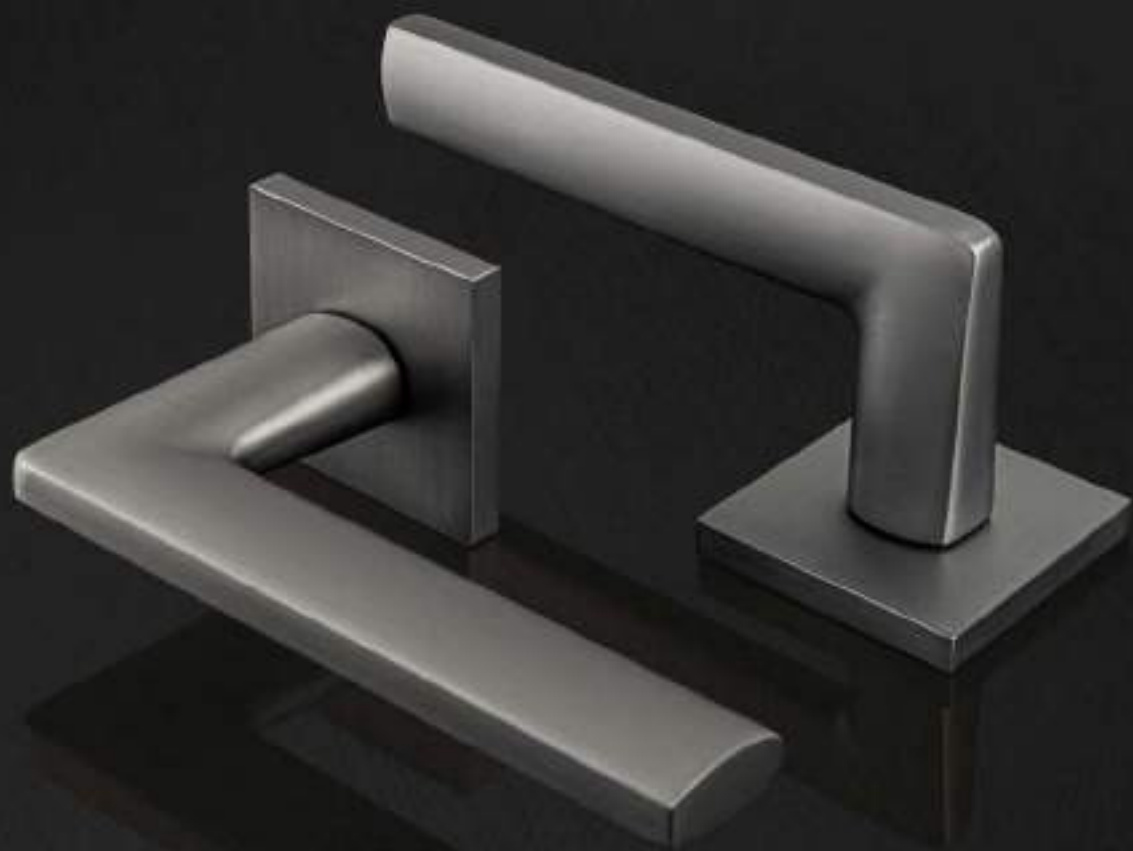

MATERIÁL: ZAMAK/HLINÍK

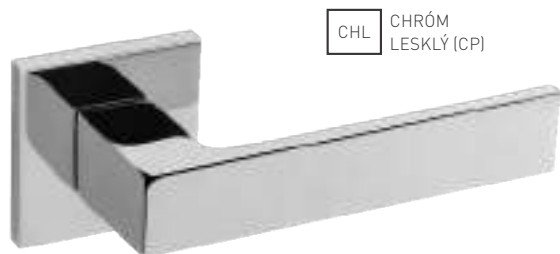

CHL CHRÓM
LESKLÝ (CP)

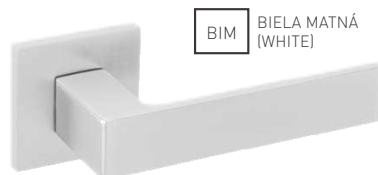
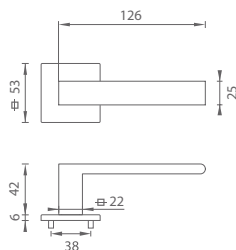

BIM BIELA MATNÁ
(WHITE)

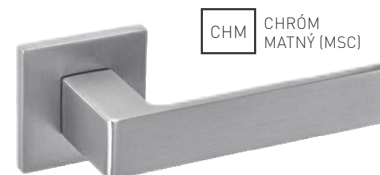

CHM CHRÓM
MATNÝ (MSC)

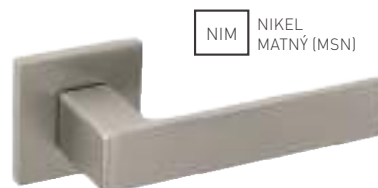

NIM NIKEL
MATNÝ (MSN)

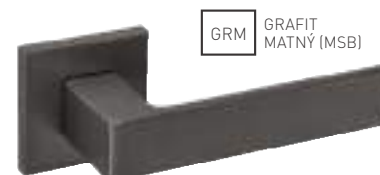

GRM GRAFIT
MATNÝ (MSB)

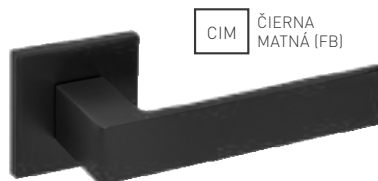

CIM ČIERNA
MATNÁ (FB)

i Kľučka na eurookno na strane 276



MP - HIT - HR SQ6

	Cena za set v €	bez DPH	s DPH
kľ./kľ. bez spodnej rozety		20,00	24,00
kľ./kľ. + rozety BBQ		28,00	33,60
kľ./kľ. + rozety PZ		28,00	33,60
kľ./kľ. + rozety WC		33,00	39,60
madlo/kľ. + rozety PZ		33,00	39,60

**OVERTE
CENU**

3
ROKY ZÁRUKA

ROKY ZÁRUKA



KR

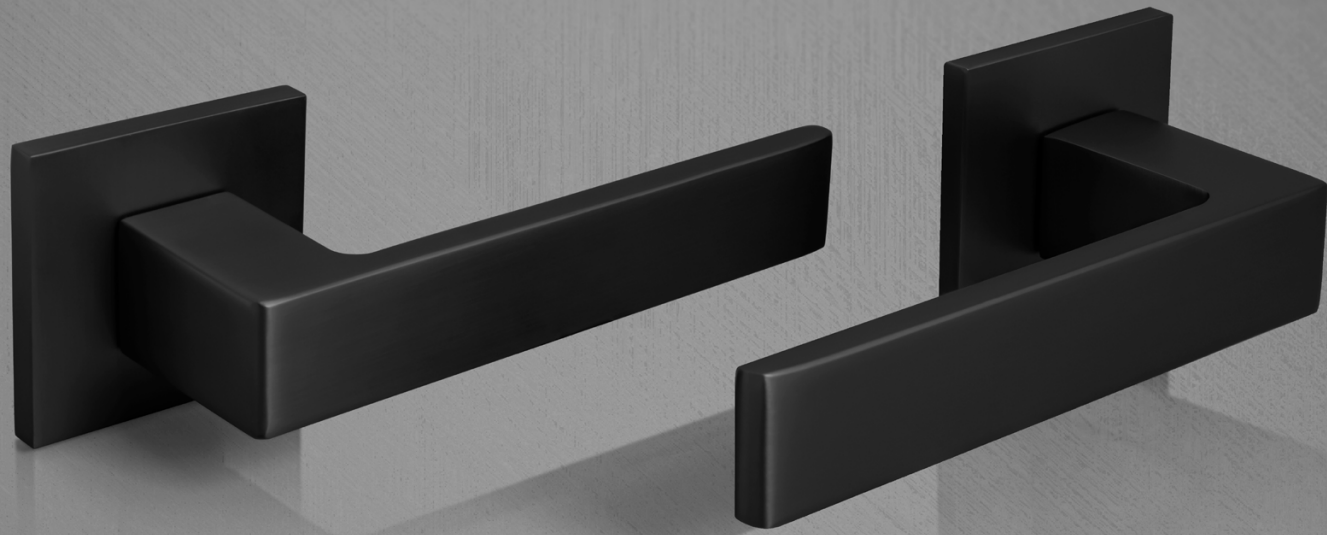

HR BBQ



CHL

BIM

CHM

NIM

GRM

CIM

HR PZ



CHL

BIM

CHM

NIM

GRM

CIM

HR WC



CHL

CHRÓM
LESKLÝ (CP)



BIM

BIELA MATNÁ
(WHITE)



CHM

CHRÓM
MATNÝ (MSC)



NIM

NIKEL
MATNÝ (MSN)



GRM

GRAFIT
MATNÝ (MSB)



CIM

ČIERNÁ
MATNÁ (FB)

MATERIÁL: ZAMAK

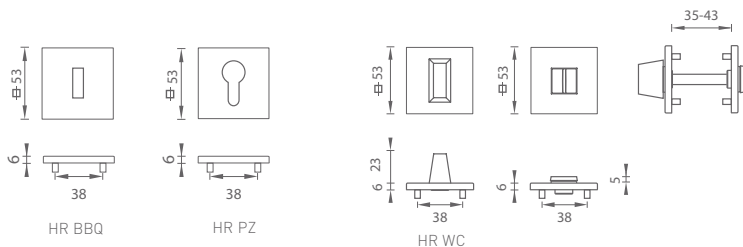

MP - ROZETA - HR SQ6

		Cena za pár v €	bez DPH	s DPH
rozety HR BBQ		8,00	8,00	9,60
rozety HR PZ		8,00	8,00	9,60
rozety HR WC		13,00	13,00	15,60

OVERTE
CENU

3
ROZET ZARIADKA



KR



CHL CHRÓM
LESKLÝ (CP)

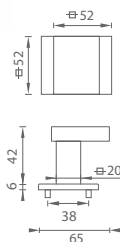

BIM BIELA MATNÁ
(WHITE)



NIM NIKEL
MATNÝ (MSN)



CIM ČIERNA
MATNÁ (FB)

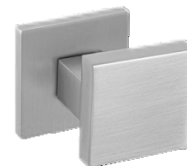

CHM CHRÓM
MATNÝ (MSC)



GRM GRAFIT
MATNÝ (MSB)

MATERIÁL: ZAMAK



MP - MADLO PEVNÉ - HR SQ6

	Cena za kus v €	bez DPH	s DPH
madlo pevné HR SQ6		15,00	18,00



OVERTE
CENU

MPK®

KĽUČKY NA DVERE

séria **BICOLOR**

Rozetové kľučky s kombinovanými povrchovými úpravami

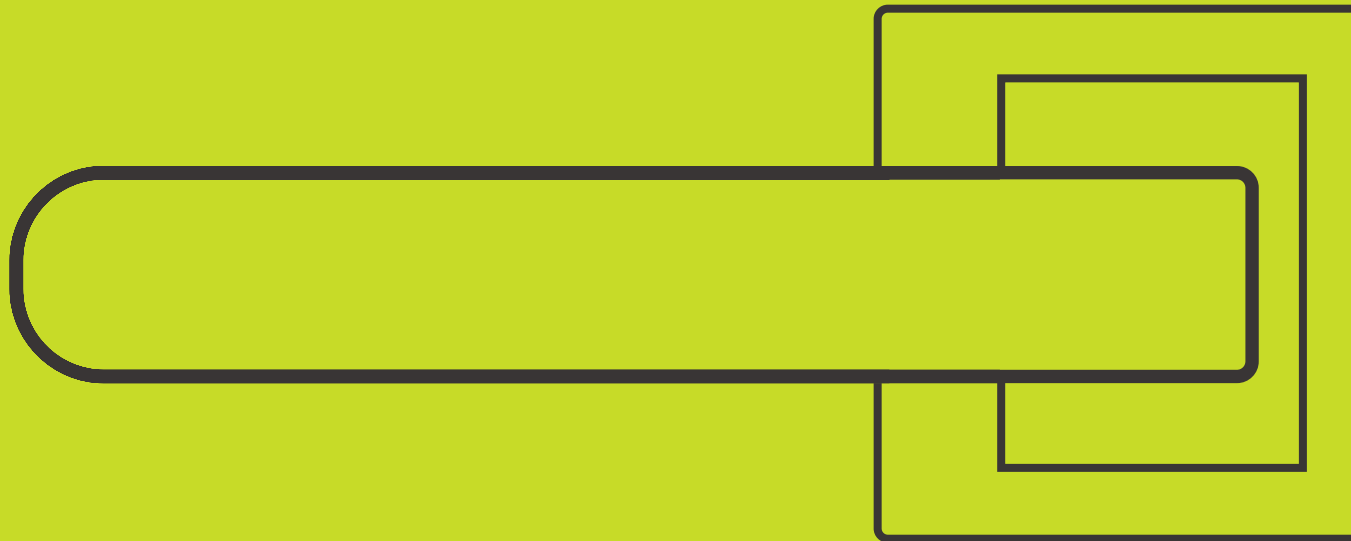

MPK®

BICOLOR

ROZETOVÉ KLUČKY
S KOMBINOVANÝMI
POVRCHOVÝMI
ÚPRAVAMI



KONŠTRUKCIA KĽUČIEK

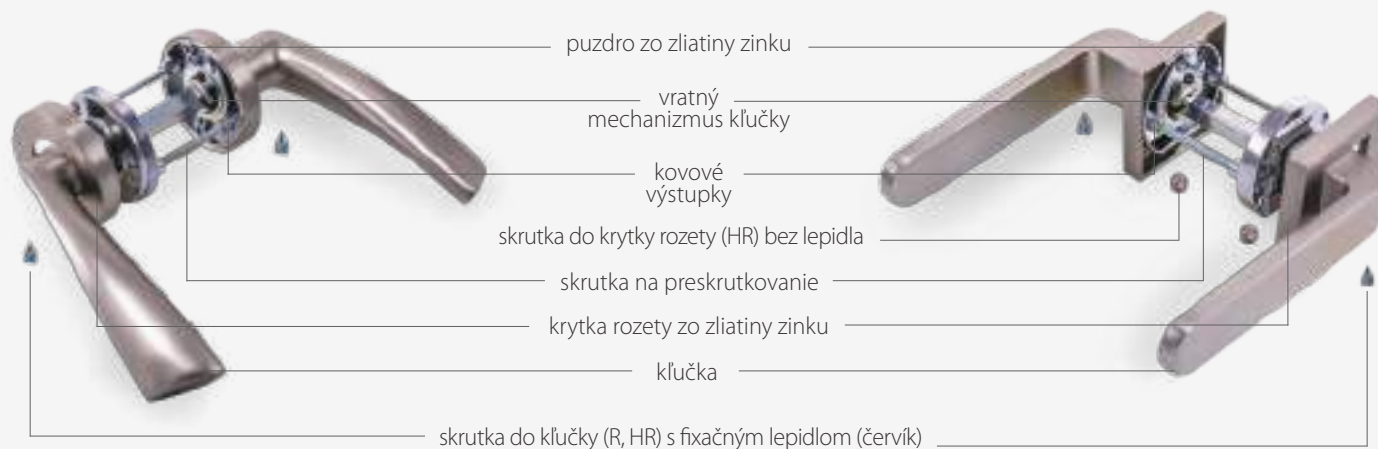

VYSVETLIVKY



predĺžená záruka 3 roky



obsahuje vratný mechanizmus kľučky - pružinu



súčasťou balenia je sada skrutiek na preskrutkovanie cez dvere



rozeta s výstupkami (zabraňuje nežiadanému pohybu rozety na dverách)



krytka rozety je závitová



krytka rozety je ukotvená skrutkou (červíkom)



kovová rozeta



NIM/
CHL NIKEL MATNÝ /
CHRÓM LESKLÝ (MSN/CP)

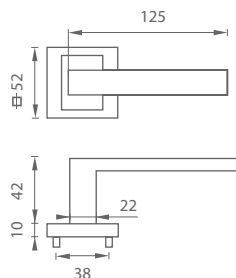

GRM/
CHL GRAFIT MATNÝ /
CHRÓM LESKLÝ (MSB/CP)



CIM/
CHL ČIERNA MATNÁ /
CHRÓM LESKLÝ (FB/CP)

i Kľučka na eurookno na strane 272



MP - HOLLY - HR

	Cena za set v €	bez DPH	s DPH
kľ./kľ. bez spodnej rozety		20,00	24,00
kľ./kľ. + rozety BB		28,00	33,60
kľ./kľ. + rozety PZ		28,00	33,60
kľ./kľ. + rozety WC		33,00	39,60
madlo/kľ. + rozety PZ		33,00	39,60

OVERTE
CENU

3

ROZET ZARIADKA



KR



MATERIÁL: HLINÍK/ZAMAK



NIM/
CHL NIKEL MATNÝ /
CHRÓM LESKLÝ (MSN/CP)

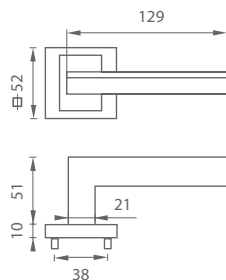

GRM/
CHL GRAFIT MATNÝ /
CHRÓM LESKLÝ (MSB/CP)



CIM/
CHL ČIERNÁ MATNÁ /
CHRÓM LESKLÝ (FB/CP)



MP - JASPER - HR

	Cena za set v €	bez DPH	s DPH
kľ./kľ. bez spodnej rozety		20,00	24,00
kľ./kľ. + rozety BB	 	28,00	33,60
kľ./kľ. + rozety PZ	 	28,00	33,60
kľ./kľ. + rozety WC	 	33,00	39,60
madlo/kľ. + rozety PZ	 	33,00	39,60

OVERTE
CENU

3
ROKY ZÁRUKA



KR





NIM/
CHL NIKEL MATNÝ /
CHRÓM LESKLÝ (MSN/CP)

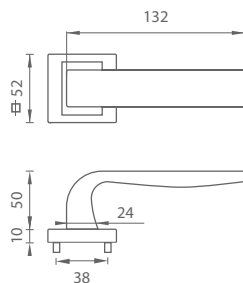

GRM/
CHL GRAFIT MATNÝ /
CHRÓM LESKLÝ (MSB/CP)



CIM/
CHL ČIERNA MATNÁ /
CHRÓM LESKLÝ (FB/CP)

i Kľučka na eurookno na strane 273



MP - CYNTHIA - HR

	Cena za set v €	bez DPH	s DPH
kľ./kľ. bez spodnej rozety		20,00	24,00
kľ./kľ. + rozety BB		28,00	33,60
kľ./kľ. + rozety PZ		28,00	33,60
kľ./kľ. + rozety WC		33,00	39,60
madlo/kľ. + rozety PZ		33,00	39,60

OVERTE
CENU

3
ROZETY KĽUČKA



KR



MATERIÁL: HLINÍK/ZAMAK



NIM/ NIKEL MATNÝ /
CHL/ CHRÓM LESKLÝ (MSN/CP)

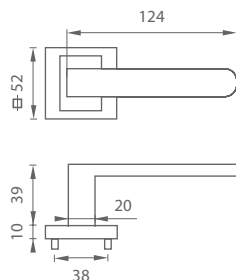

GRM/ GRAFIT MATNÝ /
CHL/ CHRÓM LESKLÝ (MSB/CP)

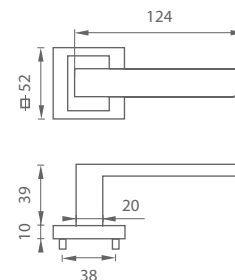

i Kľučka na eurookno na strane 271



MP - BISKIT - HR

	Cena za set v €	bez DPH	s DPH
kľ./kľ. bez spodnej rozety		20,00	24,00
kľ./kľ. + rozety BB		28,00	33,60
kľ./kľ. + rozety PZ		28,00	33,60
kľ./kľ. + rozety WC		33,00	39,60
madlo/kľ. + rozety PZ		33,00	39,60

**OVERTE
CENU**

3
ROKY ZÁRUKA



KR



MATERIÁL: HLINÍK/ZAMAK



HR BB



HR PZ



HR WC



HR BB



HR PZ



HR WC



HR BB



HR PZ



HR WC

NIM/
CHL NIKEL MATNÝ /
CHRÓM LESKLÝ (MSN/CP)

GRM/
CHL GRAFIT MATNÝ /
CHRÓM LESKLÝ (MSB/CP)

CIM/
CHL ČIERNA MATNÁ /
CHRÓM LESKLÝ (FB/CP)

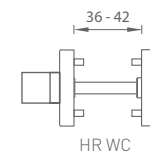
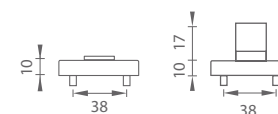
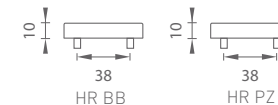

MP - ROZETA - HR

		Cena za pár v €	bez DPH	s DPH
rozety HR BB		8,00	8,00	9,60
rozety HR PZ		8,00	8,00	9,60
rozety HR WC		13,00	13,00	15,60

**OVERTE
CENU**

3

ROZET ZABŔKA



KR



NIM/
CHL NIKEL MATNÝ /
CHRÓM LESKLÝ (MSN/CP)



GRM/
CHL GRAFIT MATNÝ /
CHRÓM LESKLÝ (MSB/CP)



CIM/
CHL ČIERNÁ MATNÁ /
CHRÓM LESKLÝ (FB/CP)

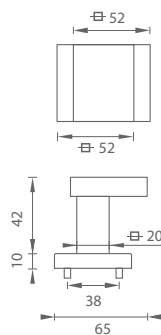

MP - MADLO PEVNÉ - HR

	Cena za kus v €	bez DPH	s DPH
madlo pevné		15,00	18,00

OVERTE
CENU

3
ROKY ZÁRUKA



KR

MATERIÁL: HLINÍK/ZAMAK

MATERIÁL: HLINÍK/ZAMAK



NIM/
CHL NIKEL MATNÝ /
CHRÓM LESKLÝ (MSN/CP)

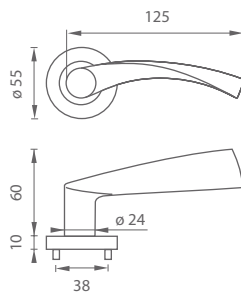

GRM/
CHL GRAFIT MATNÝ /
CHRÓM LESKLÝ (MSB/CP)

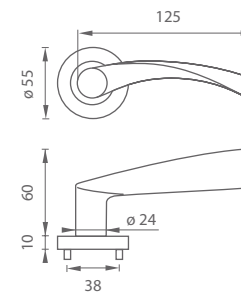

MP - SPIRIT - R

	Cena za set v €	bez DPH	s DPH
kľ./kľ. bez spodnej rozety		20,00	24,00
kľ./kľ. + rozety BB		28,00	33,60
kľ./kľ. + rozety PZ		28,00	33,60
kľ./kľ. + rozety WC		33,00	39,60
guľa/kľ. + rozety PZ		35,00	42,00

OVERTE
CENU

3
ROKY ZÁRUKA



KR



NIM/
CHL NIKEL MATNÝ /
CHRŔM LESKLÝ (MSN/CP)



GRM/
CHL GRAFIT MATNÝ /
CHRŔM LESKLÝ (MSB/CP)



NIM/
CHL NIKEL MATNÝ /
CHRŔM LESKLÝ (MSN/CP)



GRM/
CHL GRAFIT MATNÝ /
CHRŔM LESKLÝ (MSB/CP)

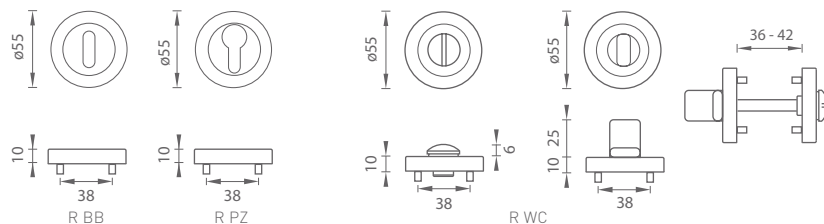
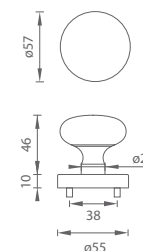

MATERIÁL: HLINÍK/ZAMAK



MP - ROZETA - R

	Cena za pár v €	bez DPH	s DPH
rozety R BB		8,00	9,60
rozety R PZ		8,00	9,60
rozety R WC		13,00	15,60

OVERTE
CENU



MP - GUĽA PEVNÁ - R

	Cena za kus v €	bez DPH	s DPH
guľa pevná		17,00	20,40



MPK®

KĽUČKY NA DVERE

séria **KLASIK**

Rozetové, štítové a okenné kľučky



MPK®

KLASIK

ROZETOVÉ, ŠTÍTOVÉ
A OKENNÉ KLUČKY

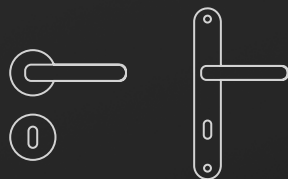
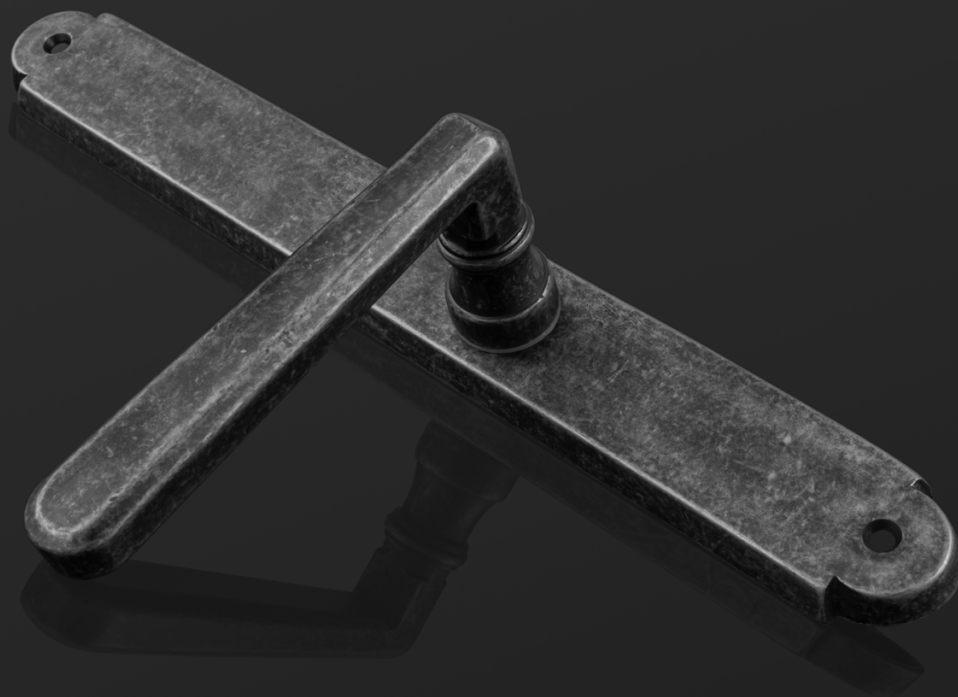

VYSVETLIVKY

3
ROKY ZÁRUKA

5
ROKOV ZÁRUKA

predĺžená záruka
3 alebo 5 rokov



obsahuje vratný mechanizmus
kľučky - pružinu



neobsahuje vratný mechanizmus
kľučky - pružinu



súčasťou balenia je sada skrutiek
na preskrutkovanie cez dvere



súčasťou balenia sú 2 kusy metrických
skrutiek 5 x 40 mm



súčasťou balenia sú samorezné skrutky
3 x 20 mm v príslušnom počte ku kovaniu



rozeta s výstupkami (zabraňuje
nežiadanému pohybu rozety na dverách)



krytka rozety je závitová

KR

kovová rozeta

72
90
ROZTEČ

rozteč - vzdialenosť medzi osou kľučky
a osou kľúča 72 alebo 90 mm

72|90
92
ROZTEČ

rozteč - vzdialenosť medzi osou kľučky a osou
kľúča je štandardne 72, 90 alebo 92 mm
(spevnené kovanie)

MATERIÁL: HLINÍK/ZAMAK



NIM NIKEL
MATNÝ (MSN)



ZLM ZLATÁ MATNÁ
(SATIN BRASS)



BRM BRONZ MATNÝ
(MATT BRONZ)

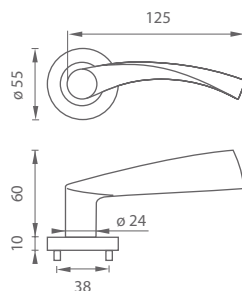

BRA BRONZ
ANTIK (DAB)



CIM ČIERNÁ
MATNÁ (FB)

i Konštrukcia kľučky na strane 113



MP - SPIRIT - R

	Cena za set v €	bez DPH	s DPH
kľ./kľ. bez spodnej rozety		20,00	24,00
kľ./kľ. + rozety BB		28,00	33,60
kľ./kľ. + rozety PZ		28,00	33,60
kľ./kľ. + rozety WC		33,00	39,60
guľa/kľ. + rozety PZ		35,00	42,00

OVERTE
CENU

3
ROKY ZÁRUKA



KR



MATERIÁL: ZAMAK/KERAMIKA



BRA BRONZ ANTIK (DAB)

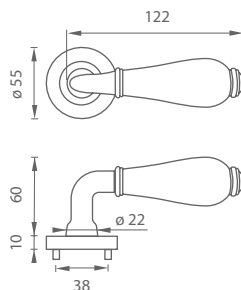

- i** Konštrukcia kľučky na strane 113
- i** Kľučka na eurookno na strane 277

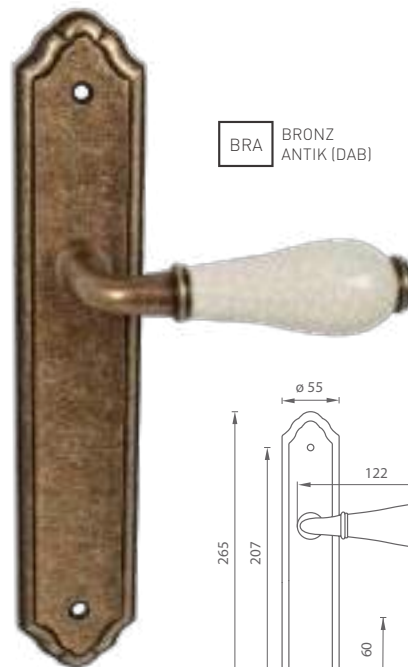

BRA BRONZ ANTIK (DAB)

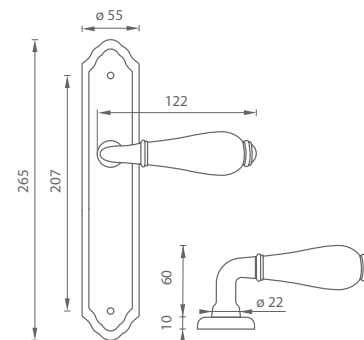

OVERTE
CENU

MP - LEONTINA - R

	Cena za set v €	bez DPH	s DPH
kľ./kľ. bez spodnej rozety		30,00	36,00
kľ./kľ. + rozety BB		38,00	45,60
kľ./kľ. + rozety PZ		38,00	45,60
kľ./kľ. + rozety WC		43,00	51,60
guľa/kľ. + rozety PZ		40,00	48,00

3
ROKY ZÁRUKA



KR

MP - LEONTINA - SO

	Cena za set v €	bez DPH	s DPH
kľ./kľ. bez otvoru		34,00	40,80
kľ./kľ. s BB otvorom pre kľúč		34,00	40,80
kľ./kľ. s PZ otvorom pre vložku		34,00	40,80
kľ./kľ. s WC kľúčom		42,00	50,40
guľa/kľ. s PZ otvorom pre vložku		40,00	48,00

3
ROKY ZÁRUKA



72
90
ROZTEČ



MATERIÁL: ZAMAK



NIM NIKEL
MATNÝ (MSN)



ZLM ZLATÁ MATNÁ
(SATIN BRASS)



BRM BRONZ MATNÝ
(MATT BRONZ)



BRA BRONZ
ANTIK (DAB)



CIM ČIERNA
MATNÁ (FB)

R BB

R PZ

R WC

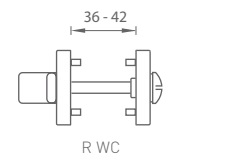
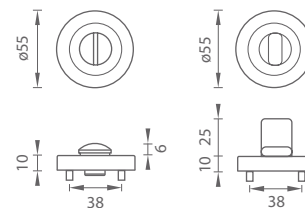
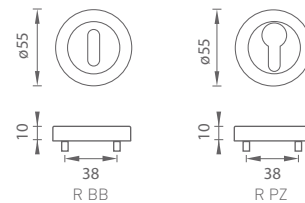

MP - ROZETA - R

	Cena za pár v €	bez DPH	s DPH
rozety R BB	8,00	8,00	9,60
rozety R PZ	8,00	8,00	9,60
rozety R WC	13,00	13,00	15,60

OVERTE
CENU

3
ROZETY ZAMAK



KR



NIM NIKEL
MATNÝ (MSN)



ZLM ZLATÁ MATNÁ
(SATIN BRASS)



BRM BRONZ MATNÝ
(MATT BRONZ)



BRA BRONZ
ANTIČ (DAB)



CIM ČIERNÁ
MATNÁ (FB)

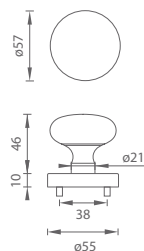

MP - GUĽA PEVNÁ - R

	Cena za kus v €	bez DPH	s DPH
guľa pevná		17,00	20,40

OVERTE
CENU



MATERIÁL: HLINÍK/ZAMAK

MATERIÁL: ZÁMAK

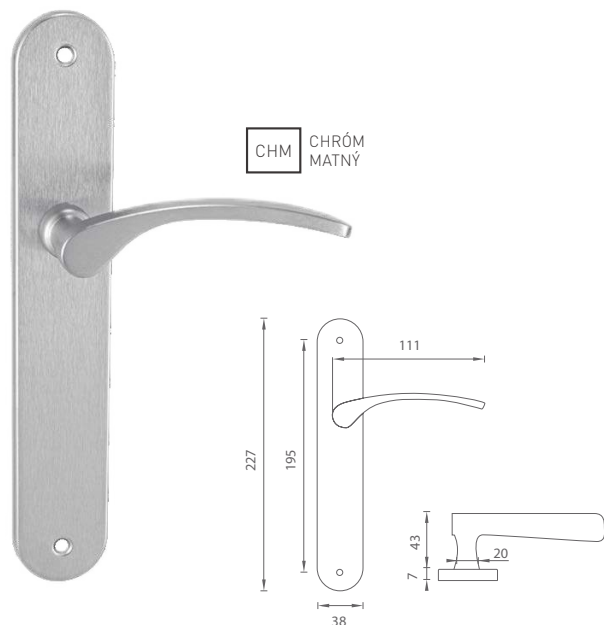

CHM CHRŮM
MATNÝ

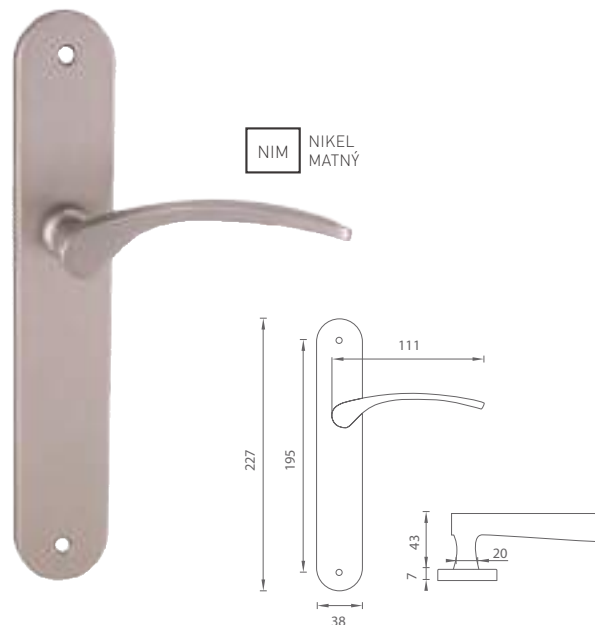

NIM NIKEL
MATNÝ

i Otvor a rozteč vyrážame na objednávku podľa typu zámku



MP - LAURA ECO - SO

	Cena za set v €	bez DPH	s DPH
kľ./kľ. bez otvoru		20,00	24,00
kľ./kľ. s BB otvorom pre kľúč		20,00	24,00
kľ./kľ. s PZ otvorom pre vložku		20,00	24,00
kľ./kľ. s WC kľúčom		28,00	33,60
guľa/kľ. s PZ otvorom pre vložku		33,50	40,20

**OVERTE
CENU**

3
ROKY ZÁMKA



**72
90**
ROZTEČ

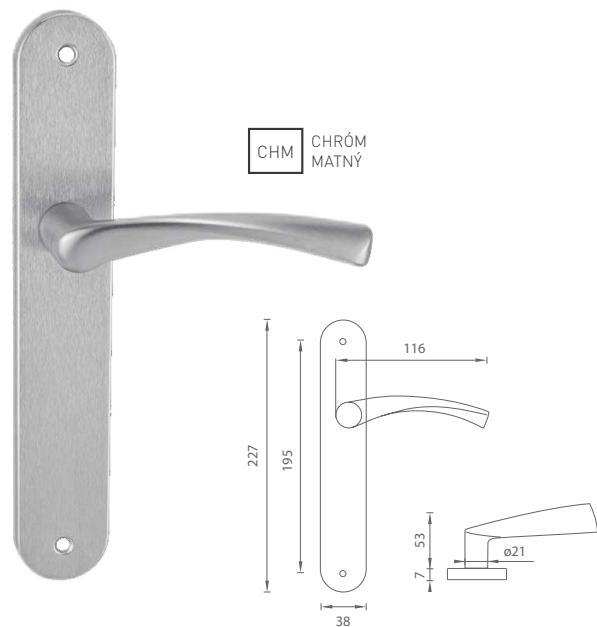

CHM CHRŮM
MATNÝ

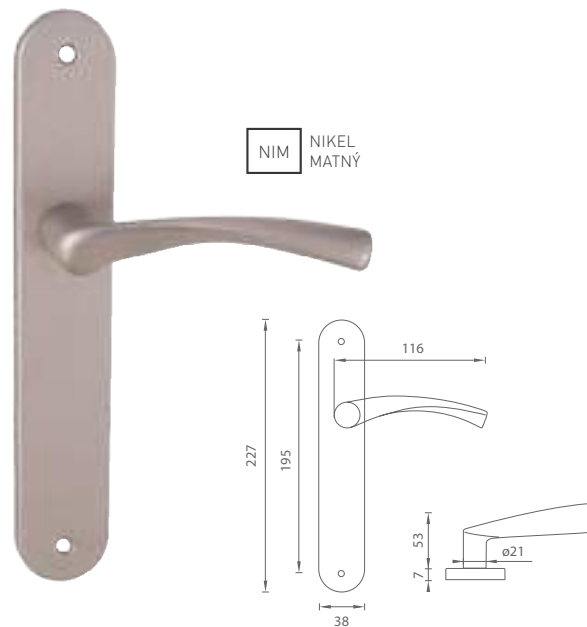





NIM NIKEL
MATNÝ

i Otvor a rozteč vyrážame na objednávku podľa typu zámku



MP - FAN ECO - SO

	Cena za set v €	bez DPH	s DPH
kľ./kľ. bez otvoru		23,00	27,60
kľ./kľ. s BB otvorom pre kľúč		23,00	27,60
kľ./kľ. s PZ otvorom pre vložku		23,00	27,60
kľ./kľ. s WC kľúčom		31,00	37,20
guľa/kľ. s PZ otvorom pre vložku		35,00	42,00

OVERTE
CENU

3
ROKY ZÁRUKA



72
90
ROZTEČ

MATERIÁL: ZAMAK

MATERIÁL: MŌSADZ



CHL CHRŌM LESKLÝ

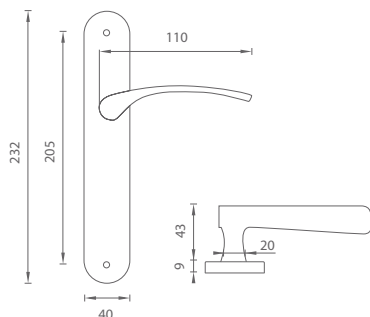

CHM CHRŌM MATNÝ



NIM NIKEL MATNÝ



ZLL ZLATÁ LESKLÁ



ZLM.NAT ZLATÁ MATNÁ NATURAL



BRM BRONZ MATNÝ







BRA BRONZ ANTIK (DAB)

i Otvor a rozteč vyrážame na objednávku podľa typu zámku



MP - LAURA - SO

Cena za set v €	ZLM.NAT		ZLL, BRM, BRA		CHL, CHM, NIM	
	bez DPH	s DPH	bez DPH	s DPH	bez DPH	s DPH
kľ./kľ. bez otvoru	28,00	33,60	30,00	36,00	33,00	39,60
kľ./kľ. s BB otvorom pre kľúč 	28,00	33,60	30,00	36,00	33,00	39,60
kľ./kľ. s PZ otvorom pre vložku 	28,00	33,60	30,00	36,00	33,00	39,60
kľ./kľ. s WC kľúčom 	36,00	43,20	38,00	45,60	41,00	49,20
guľa/kľ. s PZ otvorom pre vložku 	38,00	45,60	40,00	48,00	45,50	54,60

5
ROKOV ZÁRUKA



72
90
ROZTEČ

OVERTE CENU



CHL CHRÓM LESKLÝ

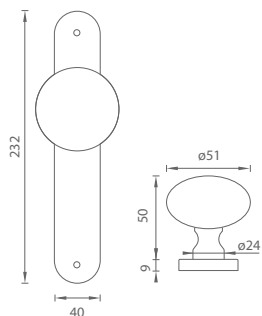

CHM CHRÓM MATNÝ



NIM NIKEL MATNÝ



ZLL ZLATÁ LESKLÁ



ZLM. NAT ZLATÁ MATNÁ NATURAL



BRM BRONZ MATNÝ





BRA BRONZ ANTIK (DAB)

i Otvor a rozteč vyrážame na objednávku podľa typu zámku



MP - LAURA GUĽA PEVNÁ - SO

Cena za kus v €	ZLM.NAT		ZLL, BRM, BRA		CHL, CHM, NIM	
	bez DPH	s DPH	bez DPH	s DPH	bez DPH	s DPH
bez otvoru	24,00	28,80	25,00	30,00	29,00	34,80
guľa s PZ otvorom pre vložku  	24,00	28,80	25,00	30,00	29,00	34,80

5
ROKOV ZÁRUKA



72
90
RÓZTEČ

OVERTE
CENU

MATERIÁL: MŌSADZ

MATERIÁL: MOSADZ



CHL CHRÓM LESKLÝ



CHM CHRÓM MATNÝ



NIM NIKEL MATNÝ



ZLL ZLATÁ LESKLÁ



ZLM. NAT ZLATÁ MATNÁ NATURAL

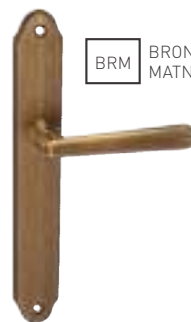

BRM BRONZ MATNÝ



BRA BRONZ ANTIK (DAB)

i Otvor a rozteč vyrážame na objednávku podľa typu zámku



OVERTE CENU

MP - ALT WIEN - SO

Cena za set v €	ZLM.NAT		ZLL, BRM, BRA		CHL, CHM, NIM	
	bez DPH	s DPH	bez DPH	s DPH	bez DPH	s DPH
kľ./kľ. bez otvoru	30,00	36,00	34,00	40,80	39,00	46,80
kľ./kľ. s BB otvorom pre kľúč	30,00	36,00	34,00	40,80	39,00	46,80
kľ./kľ. s PZ otvorom pre vložku	30,00	36,00	34,00	40,80	39,00	46,80
kľ./kľ. s WC kľúčom	38,00	45,60	42,00	50,40	47,00	56,40
guľa/kľ. s PZ otvorom pre vložku	40,00	48,00	43,00	51,60	47,50	57,00

5
ROKOV ZÁRUKA



72
90
ROZTEČ



CHL CHRÓM LESKLÝ

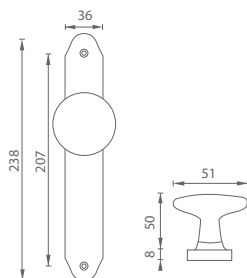

CHM CHRÓM MATNÝ



NIM NIKEL MATNÝ



ZLL ZLATÁ LESKLÁ



ZLM. NAT ZLATÁ MATNÁ NATURAL



BRM BRONZ MATNÝ





BRA BRONZ ANTIK (DAB)

i Otvor a rozteč vyrábame na objednávku podľa typu zámku



MP - ALT WIEN GUĽA PEVNÁ - S0

	ZLM.NAT		ZLL, BRM, BRA		CHL, CHM, NIM	
	bez DPH	s DPH	bez DPH	s DPH	bez DPH	s DPH
bez otvoru	25,00	30,00	26,00	31,20	28,00	33,60
s PZ otvorom pre vložku  	25,00	30,00	26,00	31,20	28,00	33,60

5
ROKOV ZÁRUKA



72
90
RÓZTEČ

OVERTE
CENU

MATERIÁL: MOSADZ

MATERIÁL: MOSADZ



CHL CHRÓM LESKLÝ

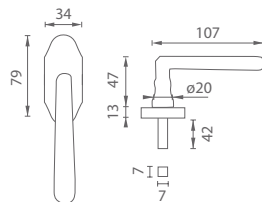

CHM CHRÓM MATNÝ



NIM NIKEL MATNÝ



ZLL ZLATÁ LESKLÁ



ZLM. NAT ZLATÁ MATNÁ NATURAL



BRM BRONZ MATNÝ



BRA BRONZ ANTIK (DAB)



MP - ALT WIEN - DKO

Cena za kus v €	ZLM.NAT		ZLL, BRM, BRA		CHL, CHM, NIM	
	bez DPH	s DPH	bez DPH	s DPH	bez DPH	s DPH
kľúčka na eurookno	18,00	21,60	20,00	24,00	22,00	26,40



OVERTE CENU



CHL CHRÓM LESKLÝ

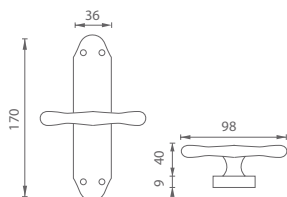

CHM CHRÓM MATNÝ



NIM NIKEL MATNÝ



ZLL ZLATÁ LESKLÁ



ZLM. NAT ZLATÁ MATNÁ NATURAL



BRM BRONZ MATNÝ



BRA BRONZ ANTIK (DAB)

MATERIÁL: MŌSADZ



MP - ALT WIEN - ROZVORA

	ZLM. NAT		ZLL, BRM, BRA		CHL, CHM, NIM	
	bez DPH	s DPH	bez DPH	s DPH	bez DPH	s DPH
rozvora	19,00	22,80	21,00	25,20	23,50	28,20



OVERTE
CENU



CHL CHRÓM LESKLÝ



CHM CHRÓM MATNÝ

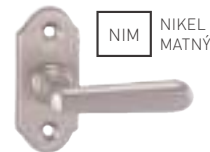

NIM NIKEL MATNÝ

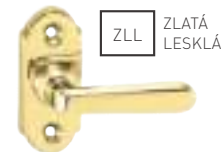

ZLL ZLATÁ LESKLÁ

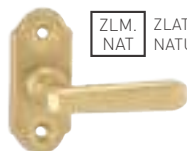
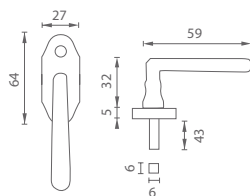

ZLM. NAT ZLATÁ MATNÁ NATURAL



BRM BRONZ MATNÝ



BRA BRONZ ANTIK (DAB)

MATERIÁL: MOSADZ



MP - ALT WIEN - POLOLIVA

	ZLM.NAT		ZLL, BRM, BRA		CHL, CHM, NIM	
	bez DPH	s DPH	bez DPH	s DPH	bez DPH	s DPH
pololiva malá	10,50	12,60	11,00	13,20	11,50	13,80



5

ROKOV ZÁRUKA



OVERTE
CENU



MATERIÁL: MOSADZ



CHL CHRÓM
LESKLÝ (CH)



CHM CHRÓM
MATNÝ (CHSAT)



NIM.LL NIKEL
MATNÝ (NISAT)



ZLL ZLATÁ
LESKLÁ (OLV)



ZLM.NAT ZLATÁ MATNÁ
(NATURAL)



ZLM ZLATÁ MATNÁ
(OBMP)

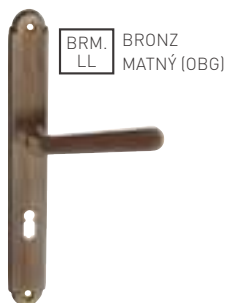

BRM.LL BRONZ
MATNÝ (OBG)



BRA BRONZ
ANTIK (OBA)



SIA SIVÁ
ANTIK (AGA)



CIS ČIERNA
ŠTRUKTUROVANÁ (NB)

detail povrchovej úpravy NB

i Otvor a rozteč vyrážame na objednávku podľa typu zámku



**OVERTE
CENU**

NI - ALT WIEN - SO	ZLM.NAT		ZLL, BRM.LL, BRA, CIS		ZLM		CHL, CHM, NIM.LL		SIA	
	bez DPH	s DPH	bez DPH	s DPH	bez DPH	s DPH	bez DPH	s DPH	bez DPH	s DPH
Cena za set v €										
kľ./kľ. bez otvoru	30,50	36,60	37,50	45,00	38,00	45,60	42,00	50,40	53,00	63,60
kľ./kľ. s BB otvorom pre kľúč	30,50	36,60	37,50	45,00	38,00	45,60	42,00	50,40	53,00	63,60
kľ./kľ. s PZ otvorom pre vložku	30,50	36,60	37,50	45,00	38,00	45,60	42,00	50,40	53,00	63,60
kľ./kľ. s WC kľúčom	40,50	48,60	47,50	57,00	48,00	57,60	52,00	62,40	63,00	75,60
guľa/kľ. s PZ otvorom pre vložku	41,00	49,20	48,00	57,60	49,50	59,40	52,00	62,40	63,00	75,60

5
NOVÝ ZÁRUKA



**72
90**
ROZTEČ



CHL CHRÓM LESKLÝ (CH)



CHM CHRÓM MATNÝ (CHSAT)



NIM.LL NIKEL MATNÝ (NISAT)



ZLL ZLATÁ LESKLÁ (OLV)



ZLM.NAT ZLATÁ MATNÁ (NATURAL)



ZLM ZLATÁ MATNÁ (OBMP)



BRM.LL BRONZ MATNÝ (OBG)



BRA BRONZ ANTIK (OBA)



SIA SIVÁ ANTIK (AGA)



CIS ČIERNÁ ŠTRUKTUROVANÁ (NB)

detail povrchovej úpravy NB

MATERIÁL: MŮSADZ

i Otvor a rozteč vyrážame na objednávku podľa typu zámku



NI - ALT WIEN GUĽA PEVNÁ - SO

Cena za kus v €	ZLM.NAT		ZLL, BRM.LL, BRA, CIS		ZLM		CHL, CHM, NIM.LL		SIA	
	bez DPH	s DPH	bez DPH	s DPH	bez DPH	s DPH	bez DPH	s DPH	bez DPH	s DPH
bez otvoru	25,50	30,60	29,00	34,80	30,50	36,60	31,00	37,20	36,00	43,20
s PZ otvorom pre vložku 	25,50	30,60	29,00	34,80	30,50	36,60	31,00	37,20	36,00	43,20

5
ROKOV ZÁRUKA



72
90
ROZTEČ

OVERTE CENU

MATERIÁL: MOSADZ



CHL CHRÓM
LESKLÝ (CH)

Guľa/kľučka bez prekrytia

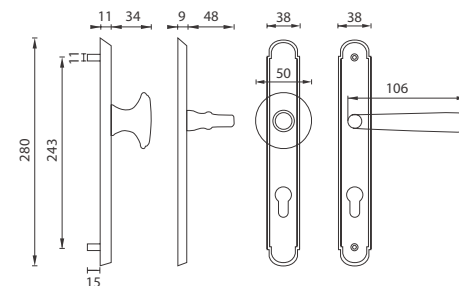

Kľučka/kľučka bez prekrytia

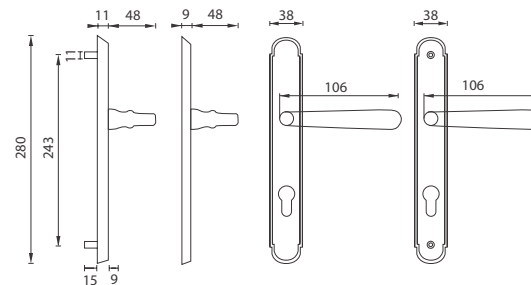

NI - ALT WIEN - SO SPEVNENÉ KOVANIE

Cena za set v €	ZLM.NAT		ZLL, BRA, BRM.LL		ZLM		CHL, CHM, NIM.LL		SIA	
	bez DPH	s DPH	bez DPH	s DPH	bez DPH	s DPH	bez DPH	s DPH	bez DPH	s DPH
kl./kl. s PZ otvorom pre vložku	81,00	97,20	90,00	108,00	93,50	112,20	97,00	116,40	109,50	131,40
guľa/kl. s PZ otvorom pre vložku	84,50	101,40	94,00	112,80	97,00	116,40	101,00	121,20	113,50	136,20

OVERTE
CENU

5
ROKOV ZÁRUKA



72/90
92
ROZTEC



MATERIÁL: MŌSADZ



CHL CHRŌM
LESKLÝ (CH)

Guľa/kľučka s prekrytím

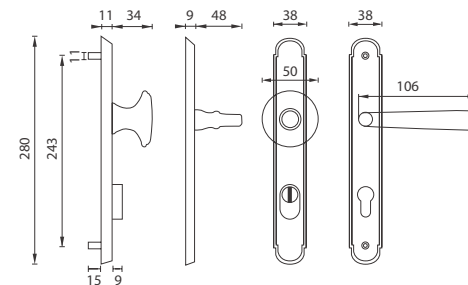

Kľučka/kľučka s prekrytím

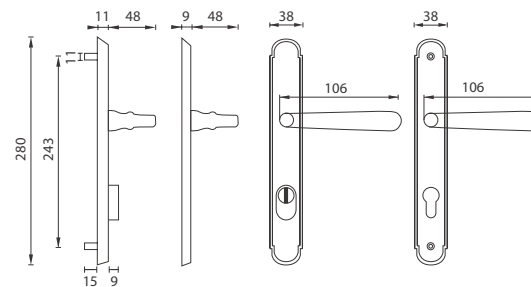

i PLUS - prekrytie cylindrickej vložky



NI - ALT WIEN PLUS - SO SPEVNENÉ KOVANIE

Cena za set v €	ZLM.NAT		ZLL, BRM.LL, BRA, CIS		ZLM		CHL, CHM, NIM.LL		SIA	
	bez DPH	s DPH	bez DPH	s DPH	bez DPH	s DPH	bez DPH	s DPH	bez DPH	s DPH
kľ./kľ. s PZ otvorom pre vložku PLUS*	126,00	151,20	138,00	165,60	141,00	169,20	144,00	172,80	158,00	189,60
guľa/kľ. s PZ otvorom pre vložku PLUS*	128,00	153,60	143,00	171,60	145,00	174,00	149,00	178,80	162,00	194,40

OVERTE
CENU

* PLUS - prekrytie cylindrickej vložky

5
ROKOV ZÁRUKA



72/90
92
ROZTEC



MATERIÁL: MŔSADZ



CHL CHRÓM
LESKLÝ (CH)



CHM CHRÓM
MATNÝ (CHSAT)



NIM.
LL NIKEL
MATNÝ (NISAT)



ZLL ZLATÁ
LESKLÁ (OLV)



ZLM.
NAT ZLATÁ MATNÁ
(NATURAL)



ZLM ZLATÁ MATNÁ
(OBMP)

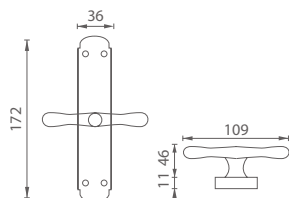

BRM.
LL BRONZ
MATNÝ (OBG)



BRA BRONZ
ANTIK (OBA)



SIA SIVÁ
ANTIK (AGA)



CIS ČIERNA
ŠTRUKTUROVANÁ (NB)

MATERIÁL: MOSADZ



NI - ALT WIEN - ROZVORA

Cena za kus v €	ZLM.NAT		ZLL, BRM.LL, BRA, CIS		ZLM		CHL, CHM, NIM.LL		SIA	
	bez DPH	s DPH	bez DPH	s DPH	bez DPH	s DPH	bez DPH	s DPH	bez DPH	s DPH
rozvora s kovovým mechanizmom	19,50	23,40	22,50	27,00	23,00	27,60	26,50	31,80	29,00	34,80

5
ROKOV ZÁRUKA



OVERTE
CENU



CHL CHRŮM
LESKLÝ (CH)

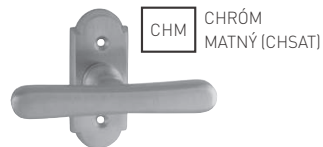
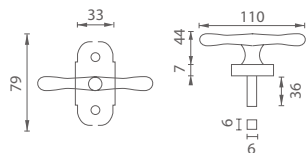

CHM CHRŮM
MATNÝ (CHSAT)

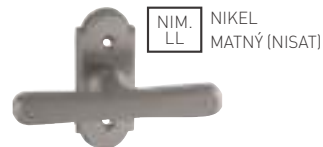

NIM.
LL NIKEL
MATNÝ (NISAT)

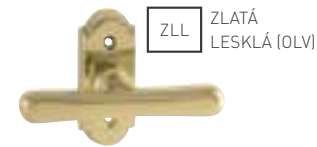

ZLL ZLATÁ
LESKLÁ (OLV)



ZLM.
NAT ZLATÁ MATNÁ
(NATURAL)



ZLM ZLATÁ MATNÁ
(OBMP)

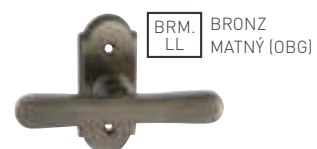

BRM.
LL BRONZ
MATNÝ (OBG)



BRA BRONZ
ANTIK (OBA)

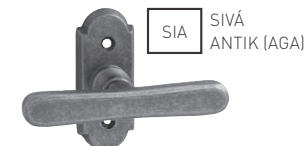

SIA SIVÁ
ANTIK (AGA)



CIS ČIERNA
ŠTRUKTUROVANÁ (NB)

MATERIÁL: MOSADZ



NI - ALT WIEN - OLIVA

	ZLM.NAT		ZLL, BRM.LL, BRA, CIS		ZLM		CHL, CHM, NIM.LL		SIA	
	bez DPH	s DPH	bez DPH	s DPH	bez DPH	s DPH	bez DPH	s DPH	bez DPH	s DPH
otliva	16,50	19,80	19,00	22,80	20,00	24,00	21,50	25,80	25,00	30,00

5
ROKOV ZÁRUKA



OVERTE
CENU

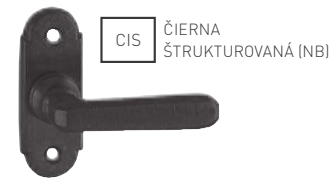
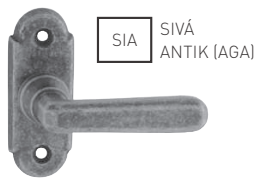
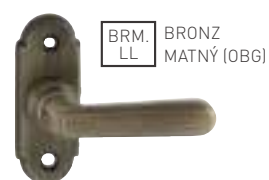
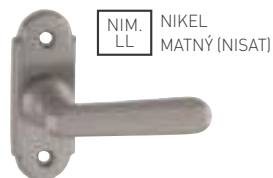
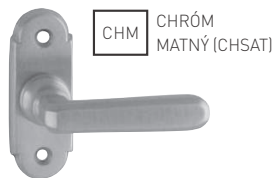
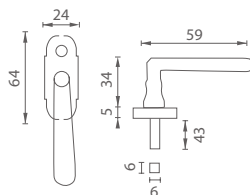

MATERIÁL: MOSADZ



NI - ALT WIEN - POLOLIVA MALÁ 1

Cena za kus v €	ZLM.NAT		ZLL, BRM.LL, BRA, CIS		ZLM		CHL, CHM, NIM.LL		SIA	
	bez DPH	s DPH	bez DPH	s DPH	bez DPH	s DPH	bez DPH	s DPH	bez DPH	s DPH
pololiva malá 1	14,00	16,80	16,00	19,20	17,00	20,40	18,50	22,20	21,00	25,20



OVERTE CENU



CHL CHRÓM
LESKLÝ (CH)

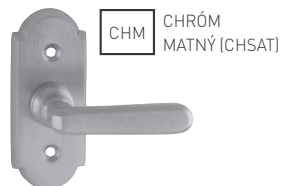
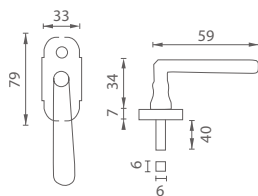

CHM CHRÓM
MATNÝ (CHSAT)



NIM.LL NIKEL
MATNÝ (NISAT)



ZLL ZLATÁ
LESKLÁ (OLV)



ZLM.NAT ZLATÁ MATNÁ
(NATURAL)



ZLM ZLATÁ MATNÁ
(OBMP)



BRM.LL BRONZ
MATNÝ (OBG)



BRA BRONZ
ANTIK (OBA)

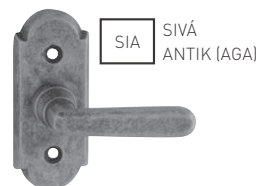

SIA SIVÁ
ANTIK (AGA)

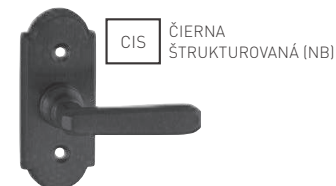

CIS ČIERNA
ŠTRUKTUROVANÁ (NB)

MATERIÁL: MOSADZ



NI - ALT WIEN - POLOLIVA MALÁ 2

Cena za kus v €	ZLM.NAT		ZLL, BRM.LL, BRA, CIS		ZLM		CHL, CHM, NIM.LL		SIA	
	bez DPH	s DPH	bez DPH	s DPH	bez DPH	s DPH	bez DPH	s DPH	bez DPH	s DPH
pololiva malá 2	14,50	17,40	16,50	19,80	17,50	21,00	19,00	22,80	21,50	25,80



OVERTE
CENU

MATERIÁL: MOSADZ



CHL CHRÓM
LESKLÝ (CH)



CHM CHRÓM
MATNÝ (CHSAT)



NIM.
LL NIKEL
MATNÝ (NISAT)



ZLL ZLATÁ
LESKLÁ (OLV)



ZLM.
NAT ZLATÁ MATNÁ
(NATURAL)



ZLM ZLATÁ MATNÁ
(OBMP)

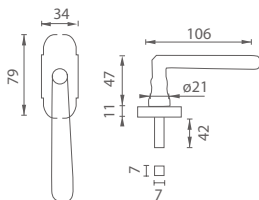

BRM.
LL BRONZ
MATNÝ (OBG)



BRA BRONZ
ANTIK (OBA)



SIA SIVÁ
ANTIK (AGA)



CIS ČIERNÁ
ŠTRUKTUROVANÁ (NB)



NI - ALT WIEN - DKO

Cena za kus v €	ZLM.NAT		ZLL, BRM.LL, BRA, CIS		ZLM		CHL, CHM, NIM.LL		SIA	
	bez DPH	s DPH	bez DPH	s DPH	bez DPH	s DPH	bez DPH	s DPH	bez DPH	s DPH
kľučka na eurookno	20,00	24,00	23,00	27,60	23,00	27,60	27,00	32,40	30,00	36,00

5
ROKOV ZÁRUKA



OVERTE
CENU



CHL CHRÓM
LESKLÝ (CH)



CHM CHRÓM
MATNÝ (CHSAT)



NIM.
LL NIKEL
MATNÝ (NISAT)



ZLL ZLATÁ
LESKLÁ (OLV)



ZLM.
NAT ZLATÁ MATNÁ
(NATURAL)



ZLM ZLATÁ MATNÁ
(OBMP)

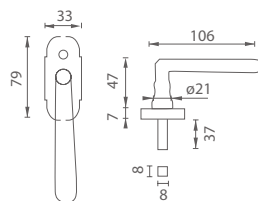

BRM.
LL BRONZ
MATNÝ (OBG)



BRA BRONZ
ANTIK (OBA)



SIA SIVÁ
ANTIK (AGA)



CIS ČIERNA
ŠTRUKTUROVANÁ (NB)

MATERIÁL: MOSADZ



NI - ALT WIEN - POLOLIVA VEĽKÁ

Cena za kus v €	ZLM.NAT		ZLL, BRM.LL, BRA, CIS		ZLM		CHL, CHM, NIM.LL		SIA	
	bez DPH	s DPH	bez DPH	s DPH	bez DPH	s DPH	bez DPH	s DPH	bez DPH	s DPH
pololiva veľká	16,50	19,80	19,00	22,80	20,00	24,00	21,50	25,80	25,00	30,00



OVERTE
CENU

MATERIÁL: MŌSADZ



CHL CHRŌM LESKLÝ



CHM CHRŌM MATNÝ



NIM NIKEL MATNÝ



ZLL ZLATÁ LESKLÁ



ZLM. NAT ZLATÁ MATNÁ NATURAL



BRM BRONZ MATNÝ







BRA BRONZ ANTIK (DAB)

i Otvor a rozteč vyrábame na objednávku podľa typu zámku



OVERTE CENU

MP - ELEGANT - SO

Cena za set v €	ZLM.NAT		ZLL, BRM, BRA		CHL, CHM, NIM	
	bez DPH	s DPH	bez DPH	s DPH	bez DPH	s DPH
kľ./kľ. bez otvoru	29,00	34,80	33,00	39,60	37,50	45,00
kľ./kľ. s BB otvorom pre kľúč 	29,00	34,80	33,00	39,60	37,50	45,00
kľ./kľ. s PZ otvorom pre vložku 	29,00	34,80	33,00	39,60	37,50	45,00
kľ./kľ. s WC kľúčom 	37,00	44,40	41,00	49,20	45,50	54,60
guľa/kľ. s PZ otvorom pre vložku 	38,50	46,20	41,50	49,80	48,00	57,60

5
ROKOV ZÁRUKA



72
90
ROZTEČ



CHL CHRÓM LESKLÝ

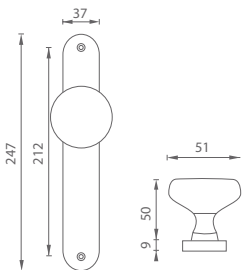

CHM CHRÓM MATNÝ



NIM NIKEL MATNÝ



ZLL ZLATÁ LESKLÁ



ZLM. NAT ZLATÁ MATNÁ NATURAL



BRM BRONZ MATNÝ



BRA BRONZ ANTIK (DAB)

i Otvor a rozteč vyrábame na objednávku podľa typu zámku



MP - ELEGANT GULÁ PEVNÁ - SO

Cena za kus v €	ZLM.NAT		ZLL, BRM, BRA		CHL, CHM, NIM	
	bez DPH	s DPH	bez DPH	s DPH	bez DPH	s DPH
bez otvoru	24,00	28,80	25,00	30,00	29,00	34,80
s PZ otvorom pre vložku 	24,00	28,80	25,00	30,00	29,00	34,80

5
ROKOV ZÁRUKA



72
90
RÓZTEC

OVERTE
CENU

MATERIÁL: MŮSADZ



CHL CHRŮM LESKLÝ



CHM CHRŮM MATNÝ



NIM NIKEL MATNÝ



ZLL ZLATÁ LESKLÁ

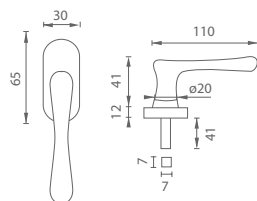

ZLM. NAT ZLATÁ MATNÁ NATURAL



BRM BRONZ MATNÝ



BRA BRONZ ANTIK (DAB)

MATERIÁL: MOSADZ



MP - ELEGANT - DKO

Cena za kus v €	ZLM.NAT		ZLL, BRM, BRA		CHL, CHM, NIM	
	bez DPH	s DPH	bez DPH	s DPH	bez DPH	s DPH
klúčka na eurookno	14,00	16,80	15,00	18,00	17,00	20,40

5

ROKOV ZÁRUKA



OVERTE CENU



CHL CHRŔM LESKLÝ



CHM CHRŔM MATNÝ



NIM NIKEL MATNÝ



ZLL ZLATÁ LESKLÁ



ZLM. NAT ZLATÁ MATNÁ NATURAL

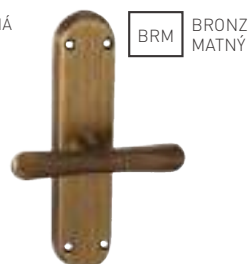

BRM BRONZ MATNÝ



BRA BRONZ ANTIK (DAB)

MATERIÁL: MŔSADZ



MP - ELEGANT - ROZVORA

	ZLM.NAT		ZLL, BRM, BRA		CHL, CHM, NIM	
	bez DPH	s DPH	bez DPH	s DPH	bez DPH	s DPH
rozvora	17,00	20,40	18,00	21,60	20,00	24,00

5

ROKOV ZÁRUKA



OVERTE
CENU



CHL CHRÓM LESKLÝ



CHM CHRÓM MATNÝ

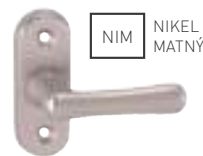

NIM NIKEL MATNÝ



ZLL ZLATÁ LESKLÁ

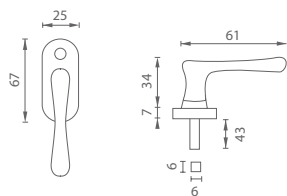

ZLM. NAT ZLATÁ MATNÁ NATURAL



BRM BRONZ MATNÝ



BRA BRONZ ANTIK (DAB)

MATERIÁL: MOSADZ



MP - ELEGANT - POLOLIVA

Cena za kus v €	ZLM.NAT		ZLL, BRM, BRA		CHL, CHM, NIM	
	bez DPH	s DPH	bez DPH	s DPH	bez DPH	s DPH
pololiva malá	8,00	9,60	9,00	10,80	10,50	12,60

5

ROKOV ZÁRUKA



OVERTE CENU



MATERIÁL: MOSADZ

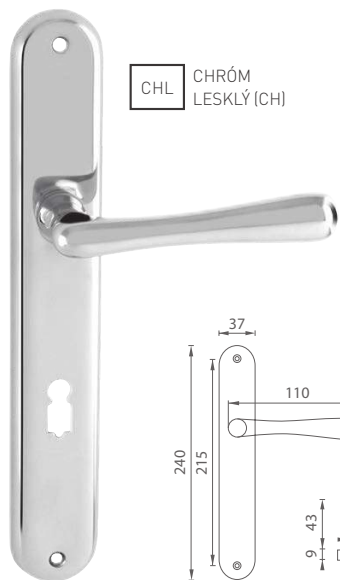

CHL CHRÓM
LESKLÝ (CH)

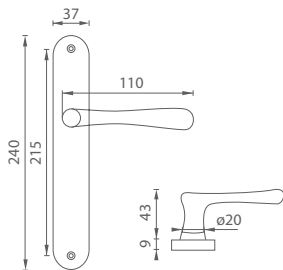

CHM CHRÓM
MATNÝ (CHSAT)



NIM.LL NIKEL
MATNÝ (NISAT)



ZLL ZLATÁ
LESKLÁ (OLV)



ZLM.NAT ZLATÁ MATNÁ
(NATURAL)



ZLM ZLATÁ MATNÁ
(OBMP)



BRM.LL BRONZ
MATNÝ (OBG)

i Otvor a rozteč vyrážame na objednávku podľa typu zámku.



OVERTE
CENU

NI - ELEGANT - SO

Cena za set v €	ZLM.NAT		ZLL, BRM.LL		ZLM		CHL, CHM, NIM.LL	
	bez DPH	s DPH	bez DPH	s DPH	bez DPH	s DPH	bez DPH	s DPH
kľ./kľ. bez otvoru	28,00	33,60	31,00	37,20	33,00	39,60	38,00	45,60
kľ./kľ. s BB otvorom pre kľúč	28,00	33,60	31,00	37,20	33,00	39,60	38,00	45,60
kľ./kľ. s PZ otvorom pre vložku	28,00	33,60	31,00	37,20	33,00	39,60	38,00	45,60
kľ./kľ. s WC kľúčom	38,00	45,60	41,00	49,20	43,00	51,60	48,00	57,60
guľa/kľ. s PZ otvorom pre vložku	39,50	47,40	45,00	54,00	47,00	56,40	50,00	60,00

5
ROKOV ZÁRUKA



72
90
ROZTEČ



CHL CHRŔM
LESKLÝ (CH)

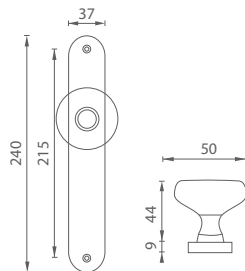

CHM CHRŔM
MATNÝ (CHSAT)



NIM.
LL NIKEL
MATNÝ (NISAT)



ZLL ZLATÁ
LESKLÁ (OLV)



ZLM.
NAT ZLATÁ MATNÁ
(NATURAL)



ZLM ZLATÁ MATNÁ
(OBMP)



BRM.
LL BRONZ
MATNÝ (OBG)

i Otvor a rozteč vyrábame na objednávku podľa typu zámku.



NI - ELEGANT GULĀ PEVNĀ - SO

Cena za kus v €	ZLM.NAT		ZLL, BRM.LL		ZLM		CHL, CHM, NIM.LL	
	bez DPH	s DPH	bez DPH	s DPH	bez DPH	s DPH	bez DPH	s DPH
bez otvoru	25,50	30,60	29,50	35,40	30,50	36,60	31,00	37,20
s PZ otvorom pre vložku	25,50	30,60	29,50	35,40	30,50	36,60	31,00	37,20

5
ROKOV ZÁRUKA



72
90
ROZTEČ

OVERTE
CENU

MATERIÁL: MŔSADZ

MATERIÁL: MOSADZ



CHL CHRÓM
LESKLÝ (CH)



CHM CHRÓM
MATNÝ (CHSAT)



NIM.LL NIKEL
MATNÝ (NISAT)



ZLL ZLATÁ
LESKLÁ (OLV)

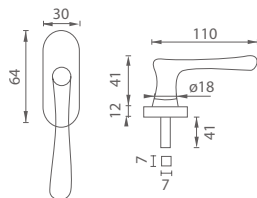

ZLM.NAT ZLATÁ MATNÁ
(NATURAL)



ZLM ZLATÁ MATNÁ
(OBMP)



BRM.LL BRONZ
MATNÝ (OBG)



NI - ELEGANT - DKO

	ZLM.NAT		ZLL, ZLM, BRM.LL		CHL, CHM, NIM.LL	
	bez DPH	s DPH	bez DPH	s DPH	bez DPH	s DPH
klúčka na eurookno	16,00	19,20	19,00	22,80	22,50	27,00



**OVERTE
CENU**



MATERIÁL: MOSADZ



CHL CHRÓM
LESKLÝ (CH)



CHM CHRÓM
MATNÝ (CHSAT)



NIM.
LL NIKEL
MATNÝ (NISAT)



ZLL ZLATÁ
LESKLÁ (OLV)

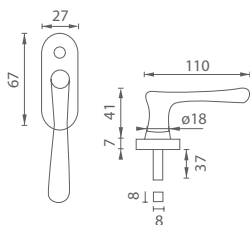

ZLM.
NAT ZLATÁ MATNÁ
(NATURAL)



ZLM ZLATÁ MATNÁ
(OBMP)



BRM.
LL BRONZ
MATNÝ (OBG)



NI - ELEGANT - POLOLIVA VEĽKÁ

	ZLM.NAT		ZLL, BRM.LL		ZLM		CHL, CHM, NIM.LL	
	bez DPH	s DPH	bez DPH	s DPH	bez DPH	s DPH	bez DPH	s DPH
pololiva veľká	14,50	17,40	17,00	20,40	18,50	22,20	19,00	22,80

Cena za kus v €

5
ROKOV ZÁRUKA



OVERTE
CENU



CHL CHRÓM
LESKLÝ (CH)

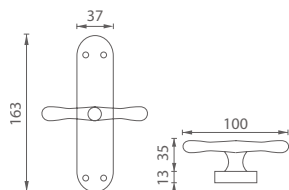

CHM CHRÓM
MATNÝ (CHSAT)



NIM.
LL NIKEL
MATNÝ (NISAT)

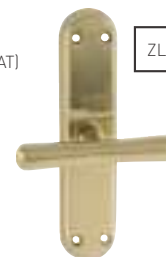

ZLL ZLATÁ
LESKLÁ (OLV)



ZLM.
NAT ZLATÁ MATNÁ
(NATURAL)



ZLM ZLATÁ MATNÁ
(OBMP)



BRM.
LL BRONZ
MATNÝ (OBG)



NI - ELEGANT - ROZVORA

	ZLM.NAT		ZLL, BRM.LL		ZLM		CHL, CHM, NIM.LL	
	bez DPH	s DPH	bez DPH	s DPH	bez DPH	s DPH	bez DPH	s DPH
rozvora	16,50	19,80	19,00	22,80	19,50	23,40	22,50	27,00

5
ROKOV ZÁRUKA



OVERTE
CENU

MATERIÁL: MŌSADZ

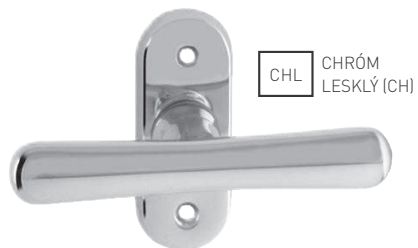

CHL CHRÓM
LESKLÝ (CH)

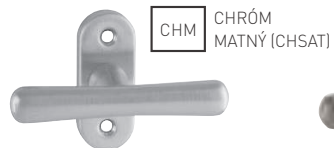

CHM CHRÓM
MATNÝ (CHSAT)

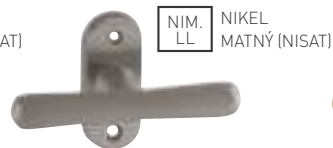

NIM.
LL NIKEL
MATNÝ (NISAT)

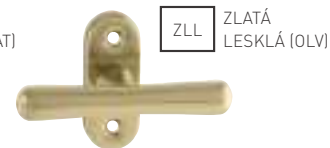

ZLL ZLATÁ
LESKLÁ (OLV)



ZLM.
NAT ZLATÁ MATNÁ
(NATURAL)



ZLM ZLATÁ MATNÁ
(OBMP)

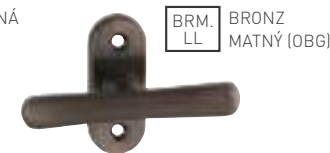

BRM.
LL BRONZ
MATNÝ (OBG)

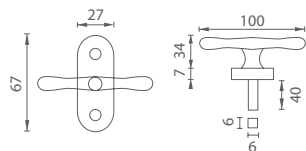

MATERIÁL: MŔSADZ



NI - ELEGANT - OLIVA

Cena za kus v €	ZLM.NAT		ZLL, BRM.LL		ZLM		CHL, CHM, NIM.LL	
	bez DPH	s DPH	bez DPH	s DPH	bez DPH	s DPH	bez DPH	s DPH
oliva	12,50	15,00	15,00	18,00	16,50	19,80	18,00	21,60



OVERTE
CENU



CHL CHRÓM
LESKLÝ (CH)

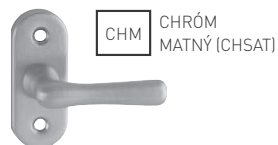
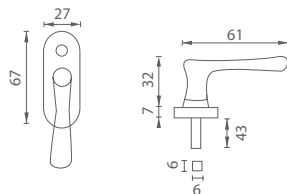

CHM CHRÓM
MATNÝ (CHSAT)



NIM.
LL NIKEL
MATNÝ (NISAT)



ZLL ZLATÁ
LESKLÁ (OLV)



ZLM.
NAT ZLATÁ MATNÁ
(NATURAL)



ZLM ZLATÁ MATNÁ
(OBMP)

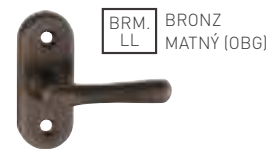

BRM.
LL BRONZ
MATNÝ (OBG)

MATERIÁL: MŌSADZ



NI - ELEGANT - POLOLIVA MALÁ

	ZLM.NAT		ZLL, BRM.LL		ZLM		CHL, CHM, NIM.LL	
	bez DPH	s DPH	bez DPH	s DPH	bez DPH	s DPH	bez DPH	s DPH
pololiva malá	11,50	13,80	13,50	16,20	16,00	19,20	17,00	20,40

5
ROKOV ZÁRUKA



OVERTE
CENU

MATERIÁL: MOSADZ

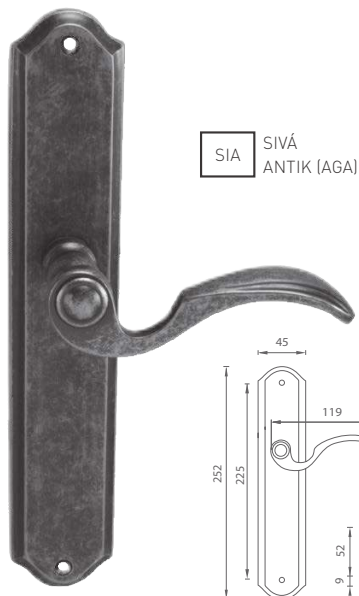

SIA SIVÁ
ANTIK (AGA)



BRM.LL BRONZ
MATNÝ (OBG)







BRA BRONZ
ANTIK (OBA)

i Otvor a rozteč vyrážame na objednávku podľa typu zámku



OVERTE
CENU

NI - RAMA - SO

	Cena za set v €	BRA, BRM.LL		SIA	
		bez DPH	s DPH	bez DPH	s DPH
kľ./kľ. bez otvoru		49,00	58,80	62,00	74,40
kľ./kľ. s BB otvorom pre kľúč		49,00	58,80	62,00	74,40
kľ./kľ. s PZ otvorom pre vložku		49,00	58,80	62,00	74,40
kľ./kľ. s WC kľúčom		59,00	70,80	72,00	86,40
guľa/kľ. s PZ otvorom pre vložku		54,50	65,40	67,00	80,40





SIA SIVÁ
ANTIK (AGA)

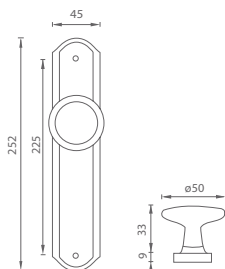

BRM.
LL BRONZ
MATNÝ (OBG)



BRA BRONZ
ANTIK (OBA)

i Otvor a rozteč vyrábame na objednávku podľa typu zámku



NI - RAMA GUĽA PEVNÁ - SO

	BRA, BRM.LL		SIA	
	bez DPH	s DPH	bez DPH	s DPH
bez otvoru	30,00	36,00	36,00	43,20
s PZ otvorom pre vložku  	30,00	36,00	36,00	43,20

5
BODOV ZÁRUKA



72
90
ROZTEČ

OVERTE
CENU

MATERIÁL: MOSADZ

MATERIÁL: MOSADZ

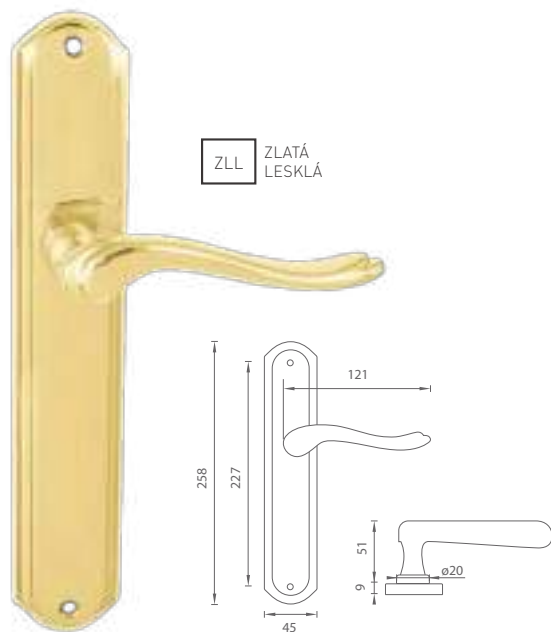

ZLL ZLATÁ
LESKLÁ



BRM BRONZ
MATNÝ



BRA ANTIK
BRONZ (DAB)

i Otvor a rozteč vyrážame na objednávku podľa typu zámku



MP - ROMEO - SO

		Cena za set v €	bez DPH	s DPH
kľ./kľ. bez otvoru			42,00	50,40
kľ./kľ. s BB otvorom pre kľúč			42,00	50,40
kľ./kľ. s PZ otvorom pre vložku			42,00	50,40
kľ./kľ. s WC kľúčom			50,00	60,00
guľa/kľ. s PZ otvorom pre vložku			50,00	60,00

**OVERTE
CENU**

3
ROKY ZÁRUKA



**72
90**
ROZTEČ



MATERIÁL: MOSADZ

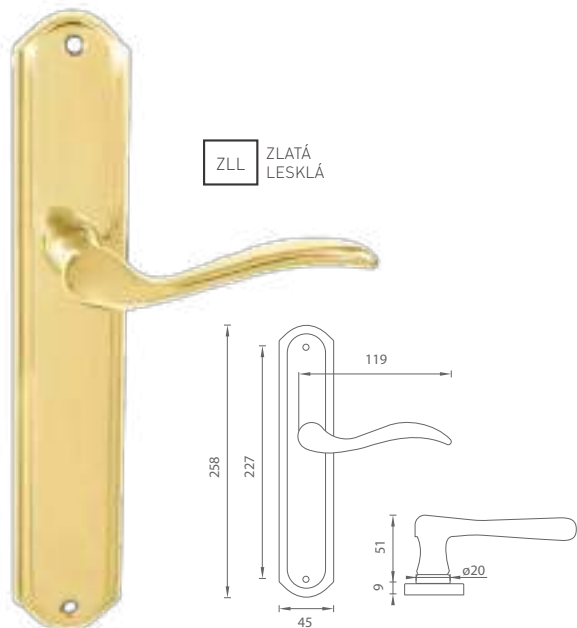

ZLL ZLATÁ
LESKLÁ



BRM BRONZ
MATNÝ



BRA ANTIK
BRONZ (DAB)

i Otvor a rozteč vyrážame na objednávku podľa typu zámku



MP - JULIA - SO

		Cena za set v €	bez DPH	s DPH
kľ./kľ. bez otvoru			42,00	50,40
kľ./kľ. s BB otvorom pre kľúč			42,00	50,40
kľ./kľ. s PZ otvorom pre vložku			42,00	50,40
kľ./kľ. s WC kľúčom			50,00	60,00
guľa/kľ. s PZ otvorom pre vložku			50,00	60,00

**OVERTE
CENU**

3
ROKY ZÁRUKA



**72
90**
ROZTEČ



ZLL ZLATÁ
LESKLÁ

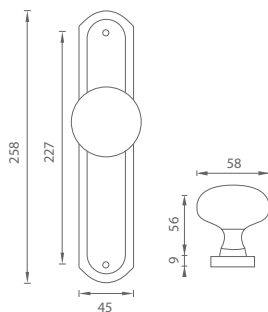

BRM BRONZ
MATNÝ





BRA ANTIK
BRONZ (DAB)

i Otvor a rozteč vyrážame na objednávku podľa typu zámku



MP - ROMEO A JULIA GUĽA PEVNÁ - S0

	Cena za kus v €	bez DPH	s DPH
bez otvoru		29,00	34,80
s PZ otvorom pre vložku  		29,00	34,80

3
ROKY ZÁRUKA



72
90
ROZTEČ

OVERTE
CENU

MATERIÁL: MOSADZ





CIK ČIERNÁ KOVANÁ

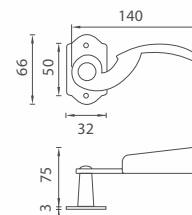
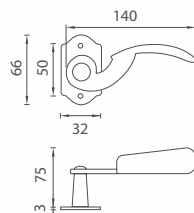

SIK SIVÁ KOVANÁ



LR - TILLY - UOR

	Cena za set v €	bez DPH	s DPH
kľ./kľ. bez spodnej rozety		61,50	73,80
kľ./kľ. + rozety BB		72,00	86,40
kľ./kľ. + rozety PZ		72,00	86,40
guľa/kľ. s PZ otvorom pre vložku		98,50	118,20

OVERTE
CENU





CIK ČIERNÁ KOVANÁ

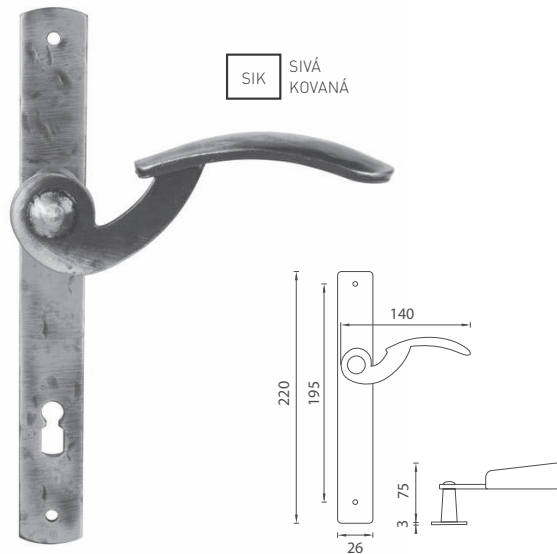





SIK SIVÁ KOVANÁ

MATERIÁL: KOVANÉ ŽELEZO



LR - TILLY - SHU

		Cena za set v €	bez DPH	s DPH
kľ./kľ. s BB otvorom pre kľúč	 		75,50	90,60
kľ./kľ. s PZ otvorom pre vložku	 		75,50	90,60

5
BOKOVÝ ZÁMOK





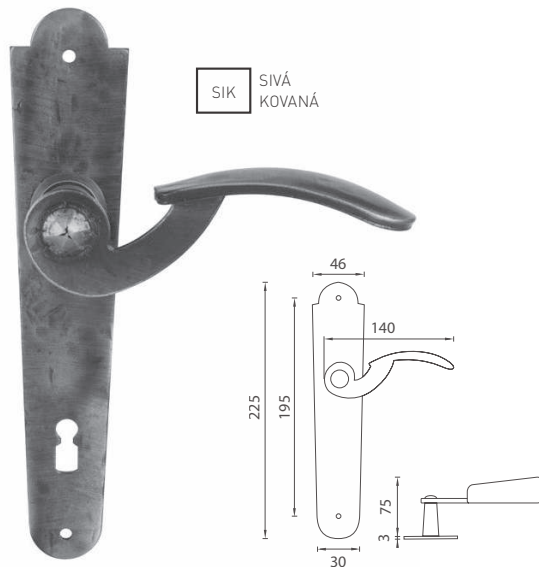
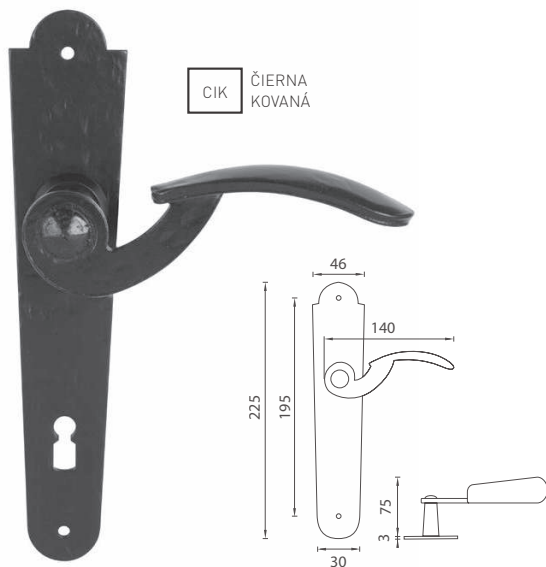

72
90
ROZTEČ

OVERTE
CENU



LR - TILLY - SO

		Cena za set v €	bez DPH	s DPH
kl./kľ. s BB otvorom pre kľúč			75,50	90,60
kl./kľ. s PZ otvorom pre vložku			75,50	90,60
kl./kľ. s WC kľúčom			95,00	114,00
guľa/kľ. s PZ otvorom pre vložku			96,50	115,80

OVERTE CENU

5
ROZMĚRY ZÁMKA



72
90
ROZTEČ

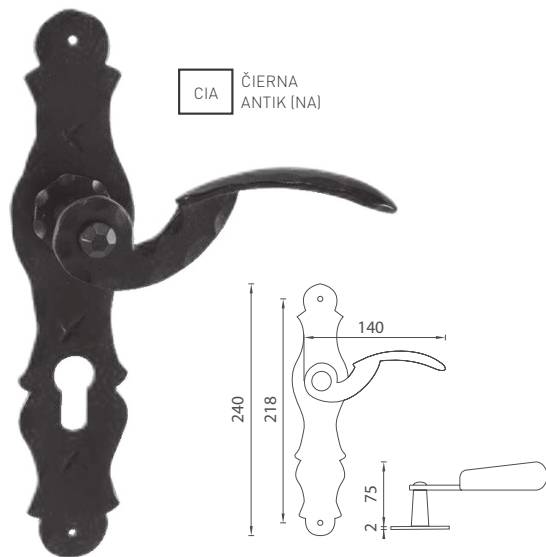

CIA ČIERNÁ ANTIK (NA)

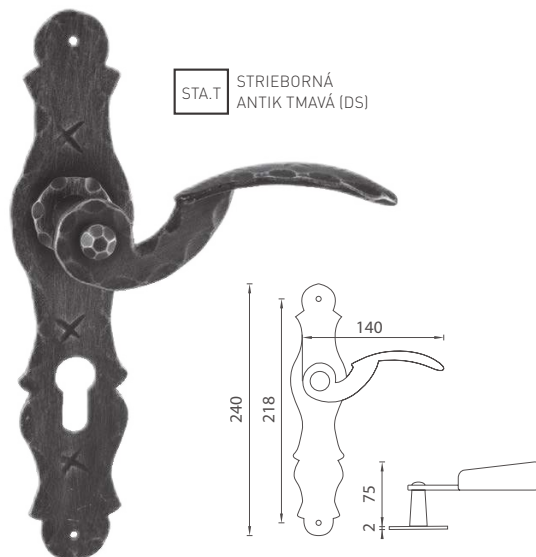





STA.T STRIEBORNÁ ANTIK TMAVÁ (DS)

MATERIÁL: KOVANÉ ŽELEZO



GA - KONSTANZ - SO

	Cena za set v €	CIA		STA.T	
		bez DPH	s DPH	bez DPH	s DPH
kl./kľ. s BB otvorom pre kľúč		42,10	50,52	62,60	75,12
kl./kľ. s PZ otvorom pre vložku		42,00	50,40	62,60	75,12
kl./kľ. s WC kľúčom		58,10	69,72	85,60	102,72
guľa/kľ. s PZ otvorom pre vložku		55,60	66,72	79,60	95,52

OVERTE CENU

5
ROKOV ZÁRUKA



72
90
ROZTEČ

VÝBER

Výber kľúčiek z európskych značiek TUPAI, GRIFFWERK, APRILE, FORME



VÝBER

VÝBER KLUČIEK
Z EURÓPSKYCH ZNAČIEK

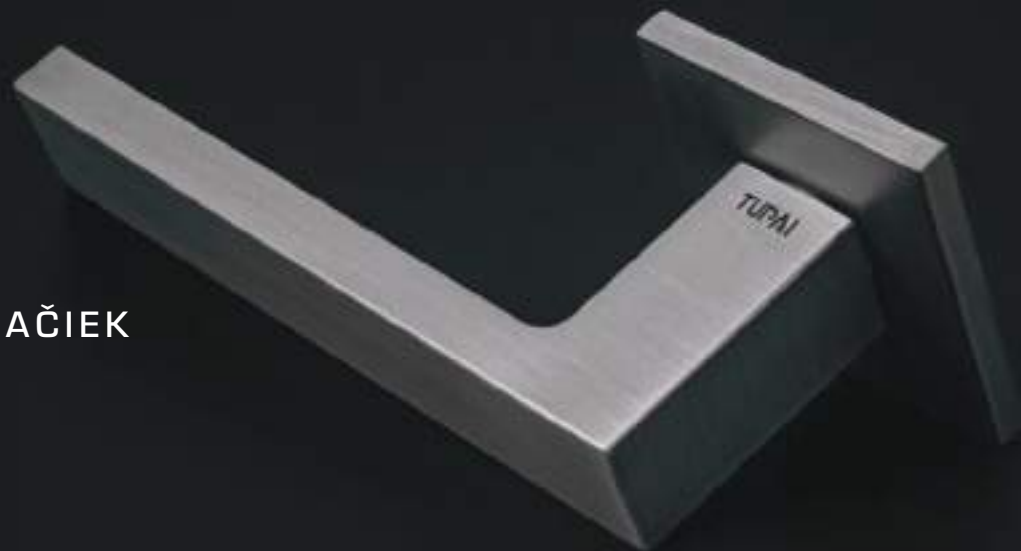

VYSVETLIVKY



predĺžená záruka 5 rokov



obsahuje vratný mechanizmus
kľučky - pružinu



rozeta s výstupkami (zabraňuje
nežiadanému pohybu rozety na dverách)



súčasťou balenia je sada skrutiek
na preskrutkovanie cez dvere



klikové nasadenie krytky rozety
na mechaniku



rozteč - vzdialenosť medzi osou kľučky
a osou kľúča 72 alebo 90 mm

TUPAI[®]



Skenuj QR pre zobrazenie všetkých
TUPAI produktov na mp-kovania.sk



MATERIÁL: NEREZ/ZAMAK

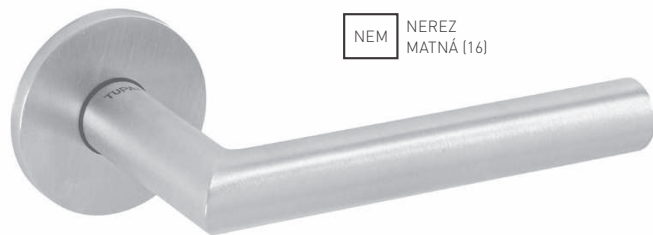

NEM NEREZ
MATNÁ (16)



BIM BIELA
MATNÁ (152)



NIM NIKEL
MATNÝ (142)



MEM MEĎ
MATNÁ (186)



GRM GRAFIT
MATNÝ (141)

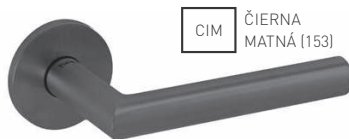

CIM ČIERNA
MATNÁ (153)

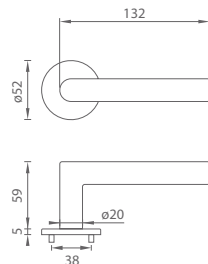

i Kľučka na eurookno na strane 280



TI - FAVORIT - R 5S 2002

Cena za set v €	NEM		BIM, MEM, CIM, NIM, GRM	
	bez DPH	s DPH	bez DPH	s DPH
kľ./kľ. bez spodnej rozety	23,00	27,60	33,50	40,20
kľ./kľ. + rozety BB	36,00	43,20	46,50	55,80
kľ./kľ. + rozety PZ	36,00	43,20	46,50	55,80
kľ./kľ. + rozety WC	43,00	51,60	53,50	64,20

OVERTE
CENU





MATERIÁL: ZAMAK



CHL CHRÓM
LESKLÝ (03)



BIM BIELA
MATNÁ (152)



CHM CHRÓM
MATNÝ (96)

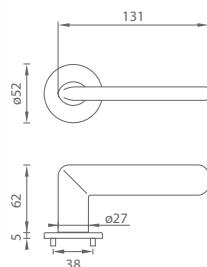

NIM NIKEL
MATNÝ (142)



GRM GRAFIT
MATNÝ (141)



CIM ČIERNA
MATNÁ (153)

i Kľučka na eurookno na strane 284



TI - ELIPTICA - R 5S 3098

	Cena za set v €	bez DPH	s DPH
kľ./kľ. bez spodnej rozety		48,00	57,60
kľ./kľ. + rozety BB		61,00	73,20
kľ./kľ. + rozety PZ		61,00	73,20
kľ./kľ. + rozety WC		68,00	81,60

**OVERTE
CENU**

5
ROKOV ZÁRUKA





CHL CHRÓM
LESKLÝ (03)

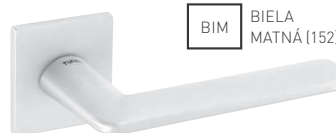

BIM BIELA
MATNÁ (152)



CHM CHRÓM
MATNÝ (96)



NIM NIKEL
MATNÝ (142)



GRM GRAFIT
MATNÝ (141)



CIM ČIERNA
MATNÁ (153)

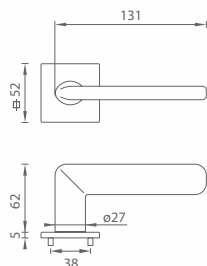

i Kľučka na eurookno na strane 285



TI - ELIPTICA - HR 5S 3098Q

	Cena za set v €	bez DPH	s DPH
kľ./kľ. bez spodnej rozety		50,00	60,00
kľ./kľ. + rozety BBQ		65,00	78,00
kľ./kľ. + rozety PZ		65,00	78,00
kľ./kľ. + rozety WC		72,00	86,40

OVERTE
CENU





CHL CHRŔM
LESKLÝ (03)

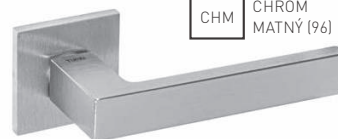

CHM CHRŔM
MATNÝ (96)



NIM NIKEL
MATNÝ (142)



GRM GRAFIT
MATNÝ (141)

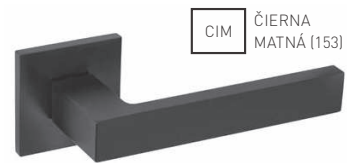

CIM ČIERNA
MATNÁ (153)

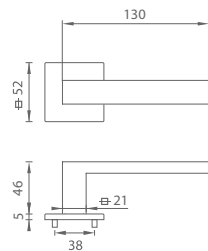

MATERIÁL: ZAMAK

i Kľučka na eurookno na strane 281



TI - SQUARE - HR 5S 2275Q

	Cena za set v €	bez DPH	s DPH
kľ./kľ. bez spodnej rozety		40,00	48,00
kľ./kľ. + rozety BBQ		55,00	66,00
kľ./kľ. + rozety PZ		55,00	66,00
kľ./kľ. + rozety WC		62,00	74,40

OVERTE
CENU



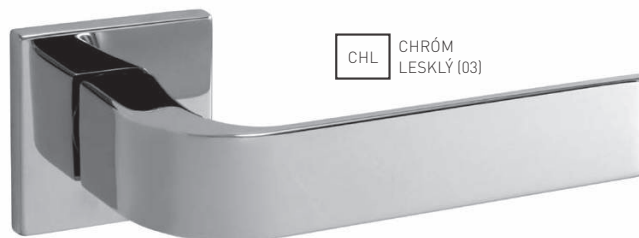

CHL CHRÓM
LESKLÝ (03)



BIM BIELA
MATNÁ (152)



CHM CHRÓM
MATNÝ (96)



NIM NIKEL
MATNÝ (142)



GRM GRAFIT
MATNÝ (141)

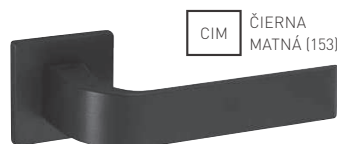

CIM ČIERNA
MATNÁ (153)

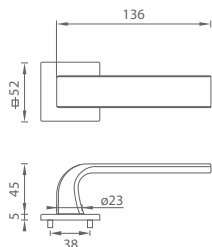

i Kľučka na eurookno na strane 283



TI - CINTO - HR 5S 2732Q

	Cena za set v €	bez DPH	s DPH
kľ./kľ. bez spodnej rozety		40,00	48,00
kľ./kľ. + rozety BBQ		55,00	66,00
kľ./kľ. + rozety PZ		55,00	66,00
kľ./kľ. + rozety WC		62,00	74,40



**OVERTE
CENU**

MATERIÁL: ZAMAK

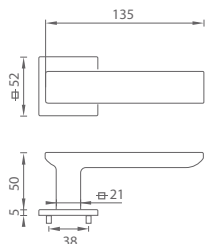
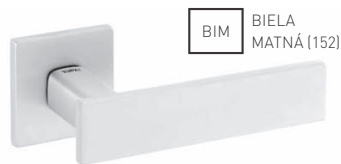
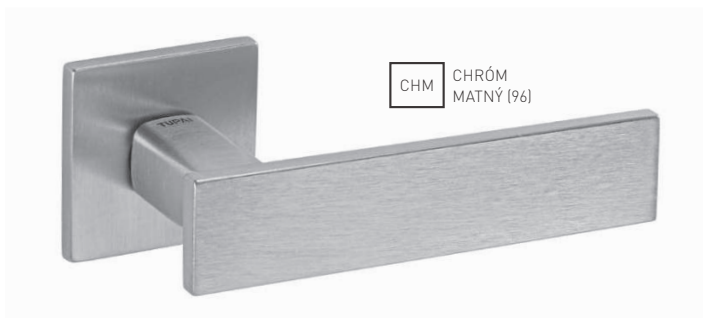

MATERIÁL: ZAMAK



TI - LINHA 2 - HR 5S 2730Q

	Cena za set v €	bez DPH	s DPH
kľ./kľ. bez spodnej rozety		50,00	60,00
kľ./kľ. + rozety BBQ		65,00	78,00
kľ./kľ. + rozety PZ		65,00	78,00
kľ./kľ. + rozety WC		72,00	86,40

OVERTE
CENU





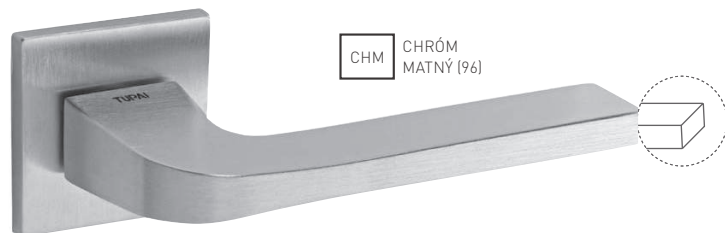

CHM CHRÓM
MATNÝ (96)



BIM BIELA
MATNÁ (152)



NIM NIKEL
MATNÝ (142)



GRM GRAFIT
MATNÝ (141)



CIM ČIERNA
MATNÁ (153)

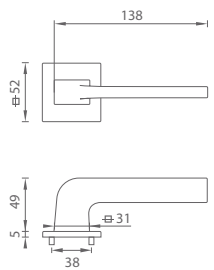

MATERIÁL: ZAMAK

i Kľučka na eurookno na strane 282



TI - SUPRA - HR 5S 3097Q

	Cena za set v €	bez DPH	s DPH
kľ./kľ. bez spodnej rozety		40,00	48,00
kľ./kľ. + rozety BBQ		55,00	66,00
kľ./kľ. + rozety PZ		55,00	66,00
kľ./kľ. + rozety WC		62,00	74,40

OVERTE
CENU

5
ROZETOV ZÁMKA

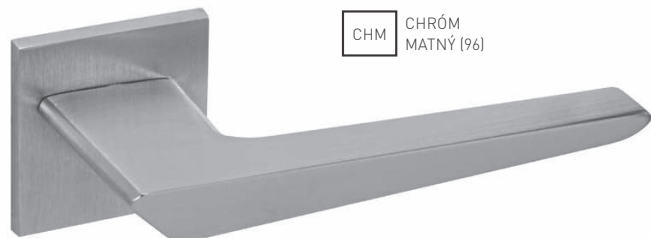

CHM CHRÓM
MATNÝ (96)

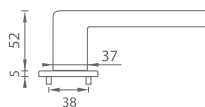
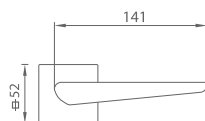

NIM NIKEL
MATNÝ (142)



GRM GRAFIT
MATNÝ (141)



CIM ČIERNA
MATNÁ (153)



TI - TIGA - HR 5S 4154Q

	Cena za set v €	bez DPH	s DPH
kľ./kľ. bez spodnej rozety		50,00	60,00
kľ./kľ. + rozety BBQ		65,00	78,00
kľ./kľ. + rozety PZ		65,00	78,00
kľ./kľ. + rozety WC		72,00	86,40

OVERTE
CENU



CHM CHRÓM
MATNÝ (96)



BIM BIELA
MATNÁ (152)



NIM NIKEL
MATNÝ (142)



GRM GRAFIT
MATNÝ (141)



CIM ČIERNA
MATNÁ (153)

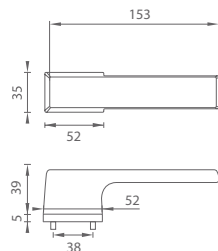
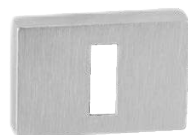

MATERIÁL: ZAMAK

i V prípade PZ setu je použitá PZ rozeta 52 x 52 mm



TI - MELODY - RT 3099

	Cena za set v €	bez DPH	s DPH
kľ./kľ. bez spodnej rozety		66,00	79,20
kľ./kľ. + rozety BBQ		81,00	97,20
kľ./kľ. + rozety PZ		81,00	97,20
kľ./kľ. + rozety WC		89,00	106,80

OVERTE
CENU





TUPAI

MATERIÁL: ZAMAK



CHM CHRÓM
MATNÝ (96)



NIM NIKEL
MATNÝ (142)

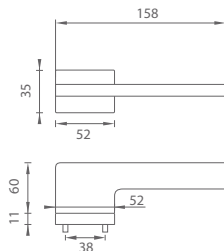
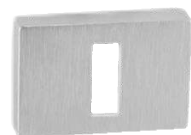

GRM GRAFIT
MATNÝ (141)



CIM ČIERNA
MATNÁ (153)

i V prípade PZ setu je použitá PZ rozeta 52 x 52 mm



TI - SALINAS - RT 4130

	Cena za set v €	bez DPH	s DPH
kľ./kľ. bez spodnej rozety		70,00	84,00
kľ./kľ. + rozety BBQ		85,00	102,00
kľ./kľ. + rozety PZ		85,00	102,00
kľ./kľ. + rozety WC		93,00	111,60

**OVERTE
CENU**



CHM CHRÓM
MATNÝ (96)



BIM BIELA
MATNÁ (152)



NIM NIKEL
MATNÝ (142)



GRM GRAFIT
MATNÝ (141)



CIM ČIERNÁ
MATNÁ (153)

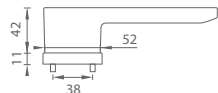
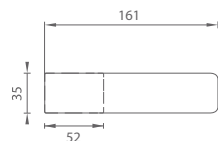
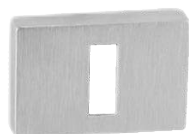

i V prípade PZ setu je použitá PZ rozeta 52 x 52 mm



TI - GORDO - RT 4084

	Cena za set v €	bez DPH	s DPH
kľ./kľ. bez spodnej rozety		70,00	84,00
kľ./kľ. + rozety BBQ		85,00	102,00
kľ./kľ. + rozety PZ		85,00	102,00
kľ./kľ. + rozety WC		93,00	111,60

OVERTE
CENU



MATERIÁL: ZAMAK

CHM CHRÓM
MATNÝ (96)

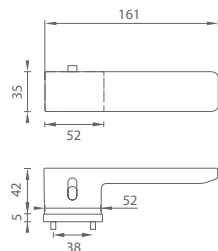
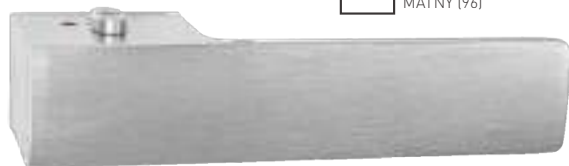

NIM NIKEL
MATNÝ (142)



GRM GRAFIT
MATNÝ (141)



CIM ČIERNA
MATNÁ (153)



TI - GORDO - RT5 4084 S UZAMYKANÍM

	Cena za set v €	bez DPH	s DPH
kľ./kľ. pre hrúbku dverí 38-45 mm		100,00	120,00
kľ./kľ. pre hrúbku dverí 46-53 mm		100,00	120,00
kľ./kľ. pre hrúbku dverí 54-61 mm		100,00	120,00

OVERTE
CENU







Skenuj QR pre zobrazenie všetkých
GriffWerk produktov na mp-kovania.sk



smart2lock
by GRIFFWERK

NIM NIKEL
MATNÝ



BIM BIELA
MATNÁ



ANM ANTRACIT
MATNÝ



CIM ČIERNA
MATNÁ

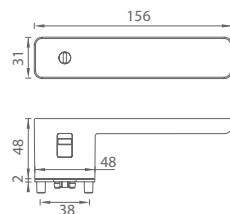

MATERIÁL: ZAMAK

i Štandardné balenie setu obsahuje sadu pre hrúbku dverí do 45 mm



OVERTE
CENU

GK - R8 ONE - S2L

	Cena za set v €	NIM		ANM, CIM		BIM	
		bez DPH	s DPH	bez DPH	s DPH	bez DPH	s DPH
kľ./kľ. s uzamykaním Li	smart2lock	161,50	193,80	170,00	204,00	170,00	204,00
kľ./kľ. s uzamykaním Re	smart2lock	161,50	193,80	170,00	204,00	170,00	204,00
sada predĺženia pre hrúbku dverí 45-50 mm		26,00	31,20	26,00	31,20	26,00	31,20
sada predĺženia pre hrúbku dverí 50-55 mm		26,00	31,20	26,00	31,20	26,00	31,20
sada predĺženia pre hrúbku dverí 55-60 mm		26,00	31,20	26,00	31,20	26,00	31,20





NIM NIKEL
MATNÝ



BIM BIELA
MATNÁ



ANM ANTRACIT
MATNÝ



CIM ČIERNA
MATNÁ

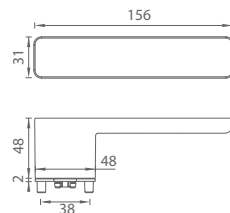

MATERIÁL: ZAMAK



GK - R8 ONE

	Cena za set v €	NIM		ANM, CIM		BIM	
		bez DPH	s DPH	bez DPH	s DPH	bez DPH	s DPH
kľ./kľ. bez spodnej rozety		118,00	141,60	126,00	151,20	126,00	151,20
kľ./kľ. + rozety BB		150,00	180,00	161,00	193,20	-	-
kľ./kľ. + rozety PZ		150,00	180,00	161,00	193,20	-	-



OVERTE
CENU

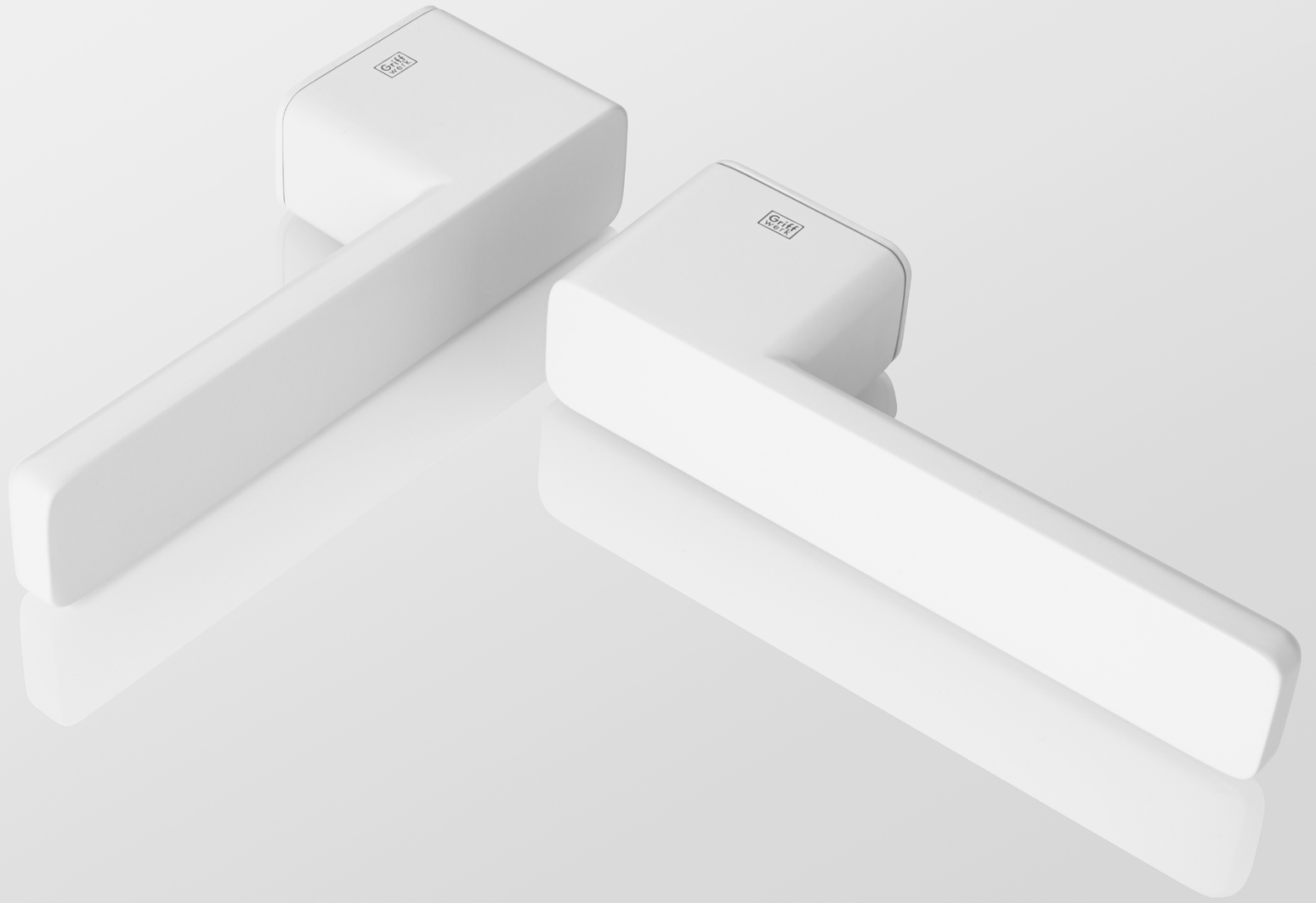

smart2lock
by GRIFFWERK

NIM NIKEL
MATNÝ

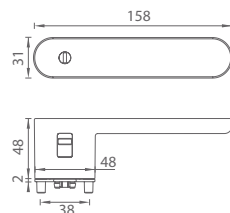

ZLM ZLATÁ
MATNÁ



ANM ANTRACIT
MATNÝ



CIM ČIERNÁ
MATNÁ



MATERIÁL: ZAMAK

i Štandardné balenie setu obsahuje sadu pre hrúbku dverí do 45 mm



OVERTE
CENU

GK - AVUS ONE - S2L	NIM		ANM, CIM		ZLM	
	bez DPH	s DPH	bez DPH	s DPH	bez DPH	s DPH
Cena za set v €						
kl./kl. s WC uzamykaním Li smart2lock	161,50	193,80	170,00	204,00	220,50	264,60
kl./kl. s WC uzamykaním Re smart2lock	161,50	193,80	170,00	204,00	220,50	264,60
sada predĺženia pre hrúbku dverí 45-50 mm	26,00	31,20	26,00	31,20	26,00	31,20
sada predĺženia pre hrúbku dverí 50-55 mm	26,00	31,20	26,00	31,20	26,00	31,20
sada predĺženia pre hrúbku dverí 55-60 mm	26,00	31,20	26,00	31,20	26,00	31,20





NIM NIKEL
MATNÝ



ZLM ZLATÁ
MATNÁ



ANM ANTRACIT
MATNÝ





CIM ČIERNA
MATNÁ

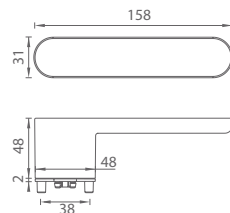

MATERIÁL: ZAMAK



GK - AVUS ONE

	Cena za set v €	NIM		ANM, CIM		ZLM	
		bez DPH	s DPH	bez DPH	s DPH	bez DPH	s DPH
kl./kľ. bez spodnej rozety		118,00	141,60	126,00	151,20	177,00	212,40
kl./kľ. + rozety BB		150,00	180,00	161,00	193,20	-	-
kl./kľ. + rozety PZ		150,00	180,00	161,00	193,20	-	-



OVERTE
CENU



APRILE



Skenuj QR pre zobrazenie všetkých
APRILE produktov na mp-kovania.sk



MATERIÁL: ZAMAK

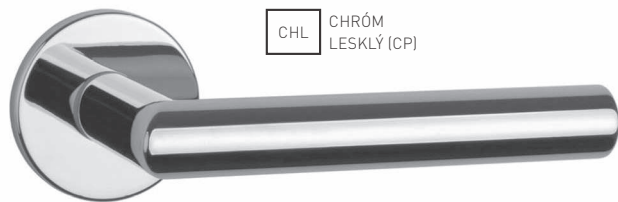

CHL CHRÓM
LESKLÝ (CP)

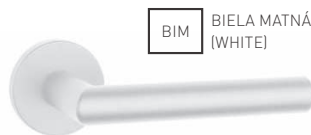
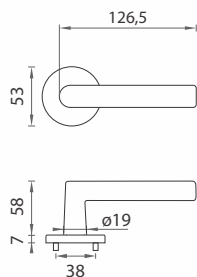

BIM BIELA MATNÁ
(WHITE)

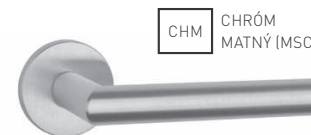

CHM CHRÓM
MATNÝ (MSC)

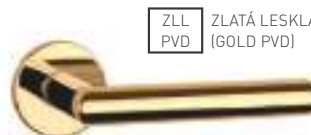

ZLL ZLATÁ LESKLÁ
PVD (GOLD PVD)

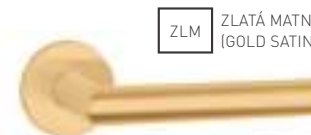

ZLM ZLATÁ MATNÁ
(GOLD SATIN)

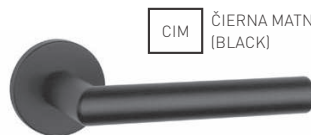

CIM ČIERNA MATNÁ
(BLACK)



OVERTE
CENU

AT - ARABIS - R 7S

	Cena za set v €	CHL, CHM, CIM		BIM, ZLL PVD		ZLM	
		bez DPH	s DPH	bez DPH	s DPH	bez DPH	s DPH
kľ./kľ. bez spodnej rozety		36,00	43,20	40,00	48,00	42,00	50,40
kľ./kľ. + rozety BB		46,00	55,20	51,00	61,20	54,00	64,80
kľ./kľ. + rozety PZ		46,00	55,20	51,00	61,20	54,00	64,80
kľ./kľ. + rozety WC		52,00	62,40	58,00	69,60	61,00	73,20
guľa/kľ. + rozety s PZ otvorom		60,00	72,00	66,00	79,20	70,00	84,00



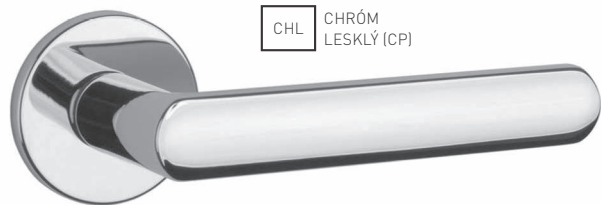

CHL CHRÓM
LESKLÝ (CP)

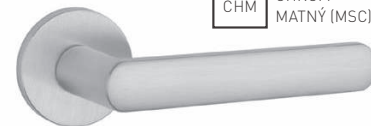
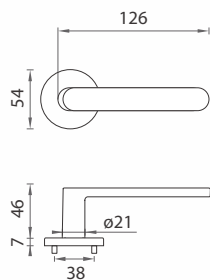

CHM CHRÓM
MATNÝ (MSC)

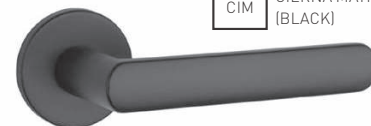

CIM ČIERNA MATNÁ
(BLACK)



OVERTE
CENU

AT - FRAGOLA - R 7S

	Cena za set v €	bez DPH	s DPH
kľ./kľ. bez spodnej rozety		36,00	43,20
kľ./kľ. + rozety BB		46,00	55,20
kľ./kľ. + rozety PZ		46,00	55,20
kľ./kľ. + rozety WC		52,00	62,40
guľa/kľ. + rozety s PZ otvorom		60,00	72,00



MATERIÁL: ZAMAK

MATERIÁL: ZAMAK



CHL CHRÓM
LESKLÝ (CP)

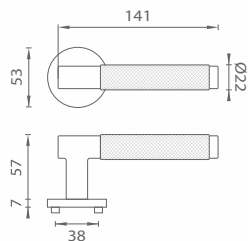

i Kľučka na eurookno na strane 278



ZLL ZLATÁ LESKLÁ
(GOLD PVD)



ZLM ZLATÁ MATNÁ
(GOLD SATIN)



CIM ČIERNA MATNÁ
(BLACK)



OVERTE
CENU

AT - MOLINIA - R 7S

	Cena za set v €	CHL, CIM		ZLL PVD		ZLM	
		bez DPH	s DPH	bez DPH	s DPH	bez DPH	s DPH
kľ./kľ. bez spodnej rozety		60,00	72,00	70,00	84,00	74,00	88,80
kľ./kľ. + rozety BB		70,00	84,00	81,00	97,20	86,00	103,20
kľ./kľ. + rozety PZ		70,00	84,00	81,00	97,20	86,00	103,20
kľ./kľ. + rozety WC		76,00	91,20	88,00	105,60	93,00	111,60
guľa/kľ. + rozety s PZ otvorom		72,00	86,40	81,00	97,20	86,00	103,20







ZLL/CHL/ZLL

Zlatá lesklá/Chróm lesklý/Zlatá lesklá (LG/LC/LG)

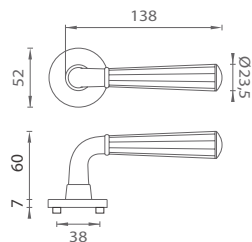

BIM/CHL/BIM

Biela matná/Chróm lesklý/Biela matná (WHITE/LC/WHITE)



ZLM/CHL/ZLM

Zlatá matná/Chróm lesklý/Zlatá matná (KG/LC/KG)



MEM PVD/CHL/MEM PVD

Meď matná/Chróm lesklý/Meď matná (PN PVD/LC/PN PVD)



CIM/CHL/CIM

Čierna matná/Chróm lesklý/Čierna matná (BK/LC/BK)

MATERIÁL: ZAMAK



ASM – MARIGOLD 3 – R 7S

	Cena za set v €	bez DPH	s DPH
kľ./kľ. bez spodnej rozety		86,00	103,20
kľ./kľ. + rozety BB		98,00	117,60
kľ./kľ. + rozety PZ		98,00	117,60
kľ./kľ. + rozety WC		106,00	127,20
guľa/kľ. + rozety s PZ otvorom		95,00	114,00

OVERTE CENU





MATERIÁL: ZAMAK



CHL/BIM/CHL



BIM/ZLL/BIM



BIM/ZLM/BIM



ZLL/BIM/ZLL



CHL/ZLL/CHL



ZLL/ZLM/ZLL



ZLM/BIM/ZLM



ZLM/ZLL/ZLM



CHL/ZLM/CHL



MEM PVD/BIM/MEM PVD



MEM PVD/ZLL/MEM PVD



MEM PVD/ZLM/MEM PVD



CIM/BIM/CIM



CIM/ZLL/CIM



CIM/ZLM/CIM



MEM PVD/BIM/MEM PVD



BIM/CIM/BIM



ZLL/MEM PVD/ZLL



ZLL/CIM/ZLL



ZLM/MEM PVD/ZLM



ZLM/CIM/ZLM



CHL/MEM PVD/CHL



MEM PVD/CIM/MEM PVD



CIM/MEM PVD/CIM



CHL/CIM/CHL

BIM Biela matná (WHITE)

CHL Chróm lesklý (LC)

ZLL Zlatá lesklá (LG)

ZLM Zlatá matná (KG)

MEM PVD Meď matná (PN PVD)

CIM Čierna matná (BK)

MATERIÁL: ZAMAK

ASM - MARIGOLD 3 - R 75

OVERTE
CENU



MATERIÁL: ZAMAK

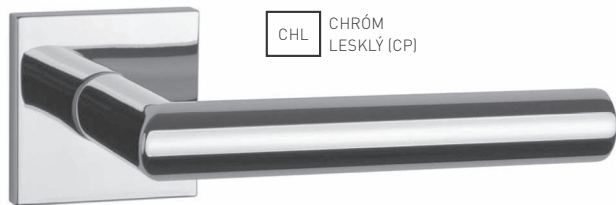

CHL CHRÓM
LESKLÝ (CP)

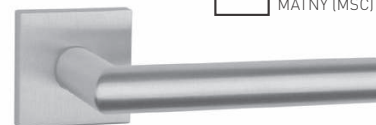
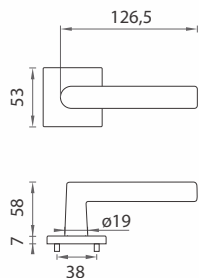

CHM CHRÓM
MATNÝ (MSC)



ZLL ZLATÁ LESKLÁ
PVD (GOLD PVD)

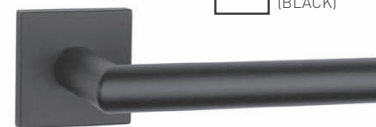





CIM ČIERNA MATNÁ
(BLACK)



OVERTE
CENU

AT - ARABIS - HR 7S

	Cena za set v €	CHL, CHM, CIM		ZLL PVD	
		bez DPH	s DPH	bez DPH	s DPH
kľ./kľ. bez spodnej rozety		38,00	45,60	42,00	50,40
kľ./kľ. + rozety BB		49,00	58,80	54,00	64,80
kľ./kľ. + rozety PZ		49,00	58,80	54,00	64,80
kľ./kľ. + rozety WC		55,00	66,00	61,00	73,20
madlo/kľ. + rozety s PZ otvorom		64,00	76,80	70,00	84,00



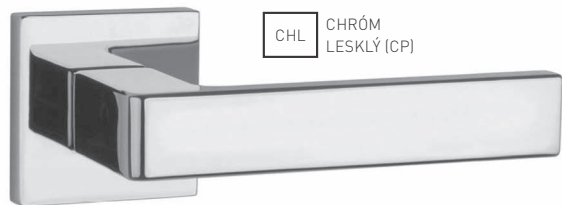

CHL CHRÓM
LESKLÝ (CP)

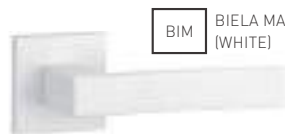
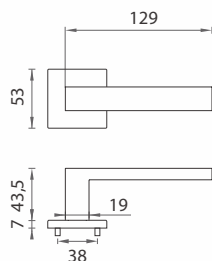

BIM BIELA MATNÁ
(WHITE)

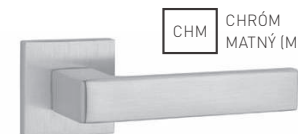

CHM CHRÓM
MATNÝ (MSC)

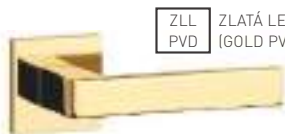

ZLL ZLATÁ LESKLÁ
PVD (GOLD PVD)

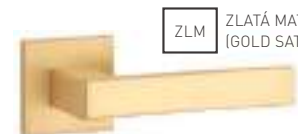

ZLM ZLATÁ MATNÁ
(GOLD SATIN)

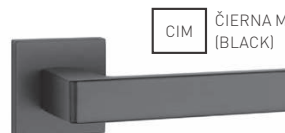





CIM ČIERNA MATNÁ
(BLACK)

MATERIÁL: ZAMAK



OVERTE
CENU

AT - SULLA - HR 7S		CHL, CHM, CIM		BIM, ZLL PVD		ZLM	
		bez DPH	s DPH	bez DPH	s DPH	bez DPH	s DPH
	Cena za set v €						
	kľ./kľ. bez spodnej rozety	38,00	45,60	42,00	50,40	46,00	55,20
	kľ./kľ. + rozety BB 	49,00	58,80	54,00	64,80	59,00	70,80
	kľ./kľ. + rozety PZ 	49,00	58,80	54,00	64,80	59,00	70,80
	kľ./kľ. + rozety WC 	55,00	66,00	61,00	73,20	66,00	79,20
	madlo/kľ. + rozety s PZ otvorom 	64,00	76,80	70,00	84,00	75,00	90,00



MATERIÁL: ZAMAK

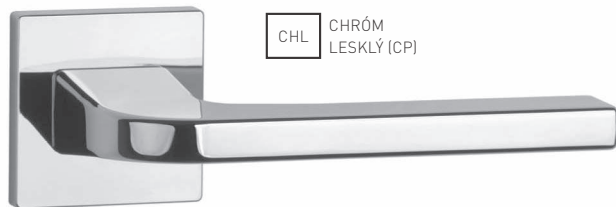

CHL CHRÓM
LESKLÝ (CP)

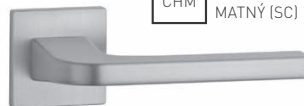
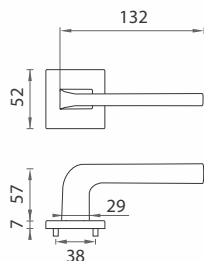

CHM CHRÓM
MATNÝ (SC)



ZLL ZLATÁ LESKLÁ
PVD (GOLD PVD)

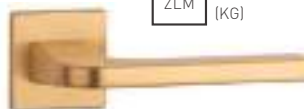

ZLM ZLATÁ MATNÁ
(KG)

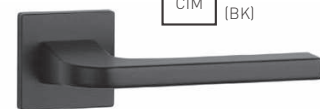

CIM ČIERNÁ MATNÁ
(BK)



OVERTE
CENU

AS - ISMENA - HR 7S

	Cena za set v €	CHL, CHM, CIM		ZLL PVD, ZLM	
		bez DPH	s DPH	bez DPH	s DPH
kľ./kľ. bez spodnej rozety		56,00	67,20	66,00	79,20
kľ./kľ. + rozety BB		68,00	81,60	79,00	94,80
kľ./kľ. + rozety PZ		68,00	81,60	79,00	94,80
kľ./kľ. + rozety WC		74,00	88,80	88,00	105,60
madlo/kľ. + rozety s PZ otvorom		78,00	93,60	88,00	105,60



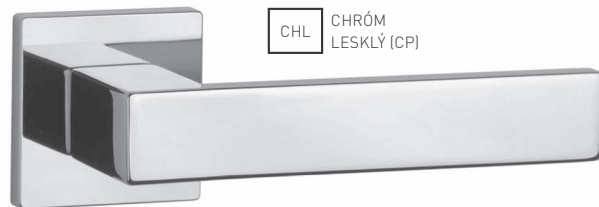

CHL CHRÓM
LESKLÝ (CP)

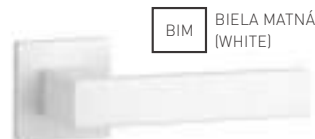
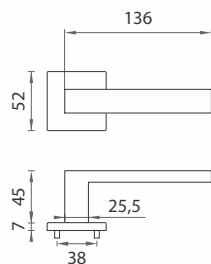

BIM BIELA MATNÁ
(WHITE)

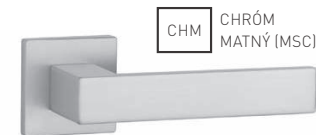

CHM CHRÓM
MATNÝ (MSC)



ZLL ZLATÁ LESKLÁ
(GOLD PVD)

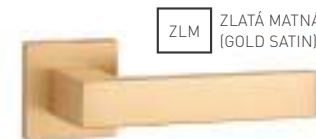

ZLM ZLATÁ MATNÁ
(GOLD SATIN)

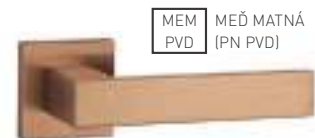

MEM MEĎ MATNÁ
(PN PVD)

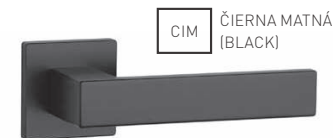

CIM ČIERNA MATNÁ
(BLACK)

MATERIÁL: ZAMAK



AS - PINA - HR 7S

	Cena za set v €	CHL, CHM, CIM		BIM, ZLL, ZLM, MEM PVD	
		bez DPH	s DPH	bez DPH	s DPH
kľ./kľ. bez spodnej rozety		55,00	66,00	60,00	72,00
kľ./kľ. + rozety BB		67,00	80,40	73,00	87,60
kľ./kľ. + rozety PZ		67,00	80,40	73,00	87,60
kľ./kľ. + rozety WC		73,00	87,60	82,00	98,40
madlo/kľ. + rozety s PZ otvorom		77,50	93,00	85,00	102,00



OVERTE
CENU

MATERIÁL: ZAMAK

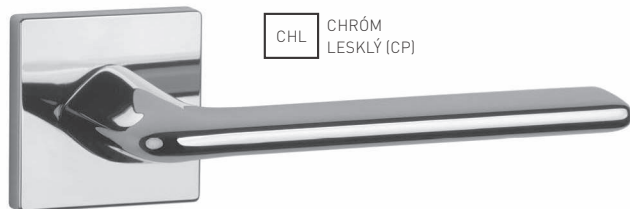

CHL CHRÓM
LESKLÝ (CP)

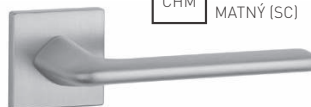
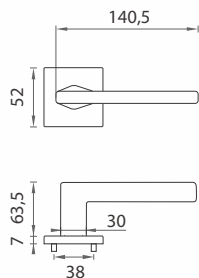

CHM CHRÓM
MATNÝ (SC)



ZLL ZLATÁ LESKLÁ
(GOLD PVD)



ZLM ZLATÁ MATNÁ
(KG)

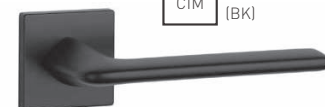

CIM ČIERNA MATNÁ
(BK)



AS - LILA - HR 7S

	Cena za set v €	CHL, CHM, CIM		ZLL, ZLM	
		bez DPH	s DPH	bez DPH	s DPH
kľ./kľ. bez spodnej rozety		52,00	62,40	62,00	74,40
kľ./kľ. + rozety BB		64,00	76,80	75,00	90,00
kľ./kľ. + rozety PZ		64,00	76,80	75,00	90,00
kľ./kľ. + rozety WC		70,00	84,00	84,00	100,80
madlo/kľ. + rozety s PZ otvorom		76,00	91,20	86,00	103,20

OVERTE
CENU



5

ROKOV ZÁRUKA

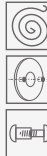

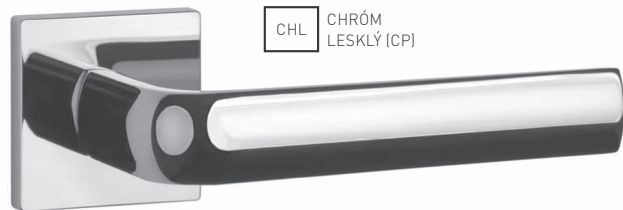

CHL CHRÓM
LESKLÝ (CP)

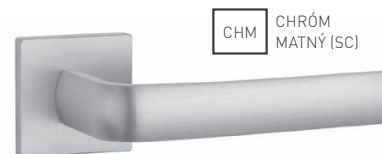
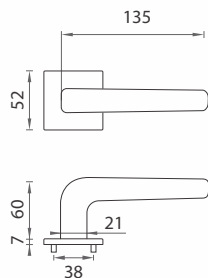

CHM CHRÓM
MATNÝ (SC)

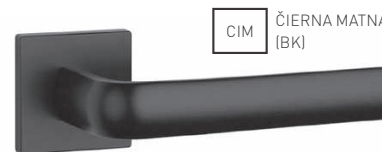

CIM ČIERNA MATNÁ
(BK)

MATERIÁL: ZAMAK



AS - MELA - HR 7S

	Cena za set v €	bez DPH	s DPH
kľ./kľ. bez spodnej rozety		52,00	62,40
kľ./kľ. + rozety BB		64,00	76,80
kľ./kľ. + rozety PZ		64,00	76,80
kľ./kľ. + rozety WC		70,00	84,00
madlo/kľ. + rozety s PZ otvorom		76,00	91,20



OVERTE
CENU

CHL CHRÓM
LESKLÝ (LC)



CHM CHRÓM
MATNÝ (SC)



CIM ČIERNA MATNÁ
(BK)

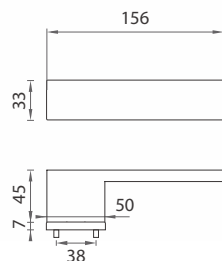

MATERIÁL: ZAMAK

i V prípade PZ setu je použitá PZ rozeta 52 x 52 mm



AS - CARLINA - RT 7S

	Cena za set v €	bez DPH	s DPH
kľ./kľ. bez spodnej rozety		75,00	90,00
kľ./kľ. + rozety BB		87,00	104,40
kľ./kľ. + rozety PZ		87,00	104,40
kľ./kľ. + rozety WC		93,00	111,60

OVERTE
CENU



CHL CHRÓM
LESKLÝ (LC)

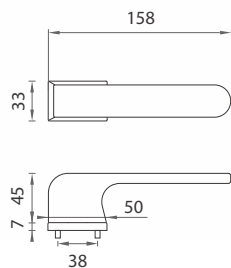

CHM CHRÓM
MATNÝ (SC)



CIM ČIERNA MATNÁ
(BK)



i V prípade PZ setu je použitá PZ rozeta 52 x 52 mm



AS - PLUMERIA - RT 7S

	Cena za set v €	bez DPH	s DPH
kľ./kľ. bez spodnej rozety		75,00	90,00
kľ./kľ. + rozety BB		87,00	104,40
kľ./kľ. + rozety PZ		87,00	104,40
kľ./kľ. + rozety WC		93,00	111,60



OVERTE
CENU

MATERIÁL: ZAMAK

CHL CHRÓM
LESKLÝ (LC)



CHM CHRÓM
MATNÝ (SC)



CIM ČIERNA MATNÁ
(BK)

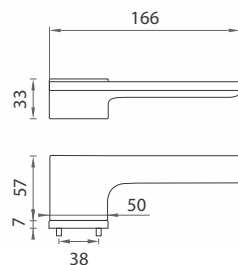

MATERIÁL: ZAMAK

i V prípade PZ setu je použitá PZ rozeta 52 x 52 mm



AS - LUPINA - RT 7S

	Cena za set v €	bez DPH	s DPH
kľ./kľ. bez spodnej rozety		80,00	96,00
kľ./kľ. + rozety BB		92,00	110,40
kľ./kľ. + rozety PZ		92,00	110,40
kľ./kľ. + rozety WC		98,00	117,60

OVERTE
CENU

5

ROZOVÝ ZÁMOK



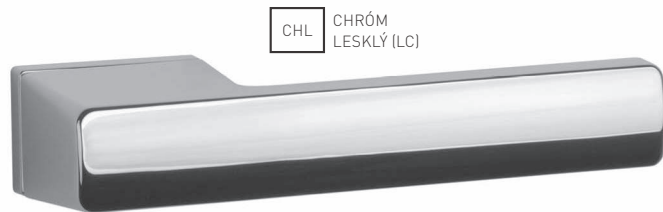

CHL CHRŔM
LESKLÝ (LC)

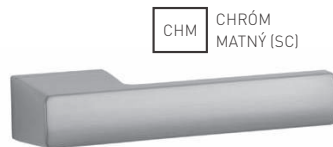

CHM CHRŔM
MATNÝ (SC)



ZLL ZLATÁ LESKLÁ
(LG PVD)



ZLM ZLATÁ MATNÁ
(KG)

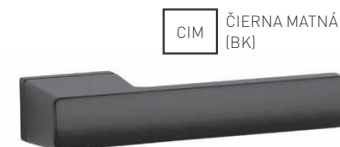

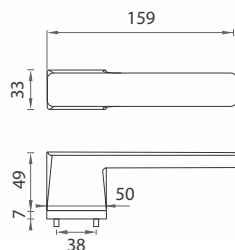

CIM ČIERNA MATNÁ
(BK)



i V prípade PZ setu je použitá PZ rozeta 52 x 52 mm



AS - BRISA - RT 7S

	Cena za set v €	CHL, CHM, CIM		ZLL, ZLM	
		bez DPH	s DPH	bez DPH	s DPH
kľ./kľ. bez spodnej rozety		75,00	90,00	88,00	105,60
kľ./kľ. + rozety BB		87,00	104,40	101,00	121,20
kľ./kľ. + rozety PZ		87,00	104,40	101,00	121,20
kľ./kľ. + rozety WC		93,00	111,60	110,00	132,00

OVERTE
CENU



CIM ČIERNA MATNÁ (BK)



CIM ČIERNA MATNÁ (BK)



MATERIÁL: ZAMAK

V prípade predvrtaných otvorov je možné kombinovať s rozetami typu RT. Pri PZ sete je použitá PZ rozeta 50 x 50 mm.

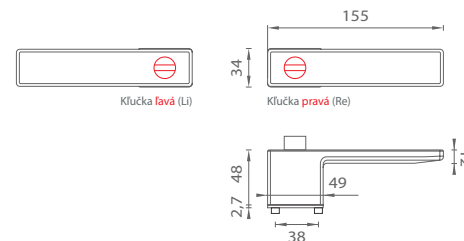
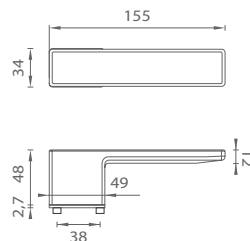

ASG - HEDERA - RT

	Cena za set v €	bez DPH	s DPH
kľ./kľ. bez uzamykania		128,00	153,60



ASG - HEDERA - RT S UZAMYKANÍM

	Cena za set v €	bez DPH	s DPH
kľ./kľ. s uzamykaním ľavá		138,00	165,60
kľ./kľ. s uzamykaním pravá		138,00	165,60



OVERTE CENU

HEDERA



CIM ČIERNA MATNÁ (BK)



CIM ČIERNA MATNÁ (BK)



V prípade predvrtaných otvorov je možné kombinovať s rozetami typu R 5S.

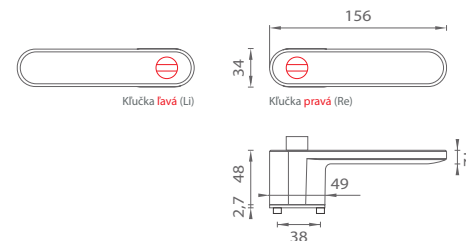
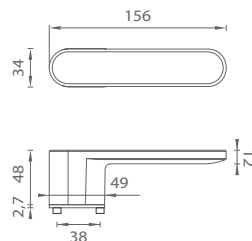

MATERIÁL: ZAMAK



ASG - GUAVA - RT

	Cena za set v €	
	bez DPH	s DPH
kľ./kľ. bez uzamykania	118,00	141,60



ASG - GUAVA - RT S UZAMYKANÍM

	Cena za set v €	
	bez DPH	s DPH
kľ./kľ. s uzamykaním ľavá	128,00	153,60
kľ./kľ. s uzamykaním pravá	128,00	153,60



OVERTE CENU

GUAVA



forme[®]



Skenuj QR pre zobrazenie všetkých
FORME produktov na mp-kovania.sk

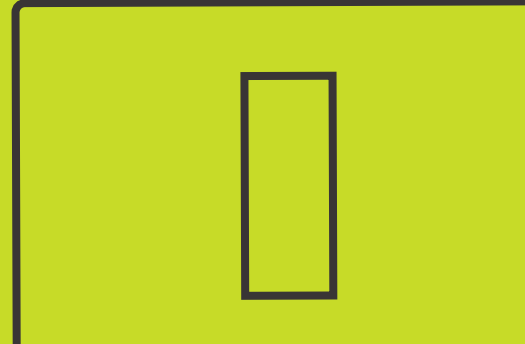

CHM CHRÓM
MATNÝ (C02)

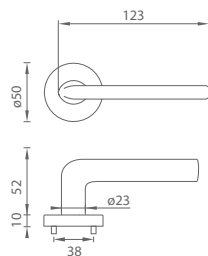
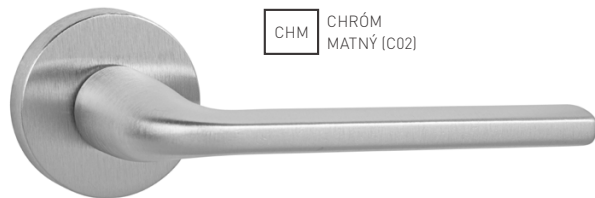

MATERIÁL: ZAMAK

NIM NIKEL
MATNÝ (N16)



ZLM ZLATÁ
MATNÁ (S02)



ANM ANTRACIT
MATNÝ (G01)

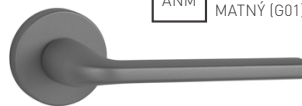

HNM HNEDÁ
MATNÁ (B11)



CIM ČIERNA
MATNÁ (N52)



FO - MILLY - R

	Cena za set v €	bez DPH	s DPH
kľ./kľ. bez spodnej rozety		36,00	43,20
kľ./kľ. + rozety BB		46,00	55,20
kľ./kľ. + rozety PZ		46,00	55,20
kľ./kľ. + rozety WC		54,00	64,80
guľa/kľ. + rozety s PZ otvorom		68,00	81,60

OVERTE
CENU





NIM NIKEL
MATNÝ (N16)

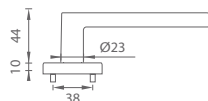
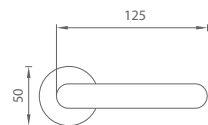

ZLM ZLATÁ
MATNÁ (S02)

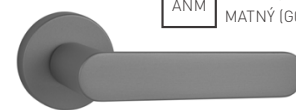

ANM ANTRACIT
MATNÝ (G01)



HNM HNEDÁ
MATNÁ (B11)

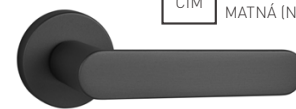



CIM ČIERNA
MATNÁ (N52)



OVERTE
CENU

FO - ROUND - R

	Cena za set v €	bez DPH	s DPH
kľ./kľ. bez spodnej rozety		39,00	46,80
kľ./kľ. + rozety BB		49,00	58,80
kľ./kľ. + rozety PZ		49,00	58,80
kľ./kľ. + rozety WC		57,00	68,40
guľa/kľ. + rozety s PZ otvorom		69,50	83,40



CHL CHRÓM
LESKLÝ (C01)

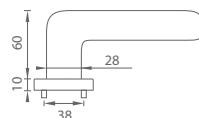
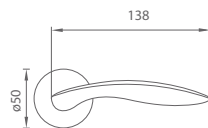

CHM CHRÓM
MATNÝ (C02)



NIM NIKEL
MATNÝ (N16)



ZLM ZLATÁ
MATNÁ (S02)



ANM ANTRACIT
MATNÝ (G01)

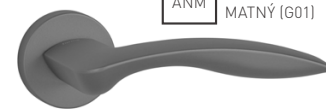

HNM HNEDÁ
MATNÁ (B11)





CIM ČIERNA
MATNÁ (N52)



MATERIÁL: ZAMAK



FO - CHICAGO - R

	Cena za set v €	bez DPH	s DPH
kľ./kľ. bez spodnej rozety		65,50	78,60
kľ./kľ. + rozety BB		75,50	90,60
kľ./kľ. + rozety PZ		75,50	90,60
kľ./kľ. + rozety WC		83,50	100,20
guľa/kľ. + rozety s PZ otvorom		83,00	99,60

OVERTE
CENU





ZLL ZLATÁ
LESKLÁ (L01)

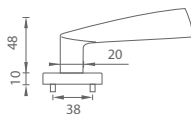
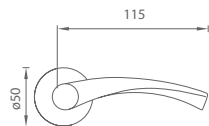

NIM NIKEL
MATNÝ (N16)



ZLM ZLATÁ
MATNÁ (S02)



BRM BRONZ
MATNÝ (B03)



ANM ANTRACIT
MATNÝ (G01)







HNM HNEDÁ
MATNÁ (B11)



MATERIÁL: ZAMAK



FO - FAN - R

		Cena za set v €	bez DPH	s DPH
kľ./kľ. bez spodnej rozety			36,00	43,20
kľ./kľ. + rozety BB			46,00	55,20
kľ./kľ. + rozety PZ			46,00	55,20
kľ./kľ. + rozety WC			54,00	64,80
guľa/kľ. + rozety s PZ otvorom			68,50	82,20

**OVERTE
CENU**

5
ROKOV ZÁRUKA





ZLL ZLATÁ
LESKLÁ (L01)

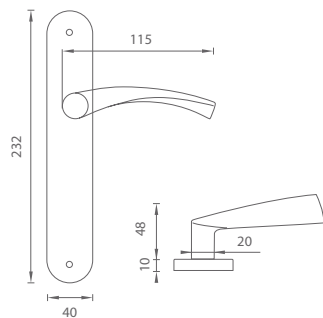

NIM NIKEL
MATNÝ (N16)



ZLM ZLATÁ
MATNÁ (S02)



BRM BRONZ
MATNÝ (B03)







ANM ANTRACIT
MATNÝ (G01)



HNM HNEDÁ
MATNÁ (B11)



FO - FAN - SO

		Cena za set v €	bez DPH	s DPH
kľ./kľ. bez otvoru			37,00	44,40
kľ./kľ. s BB otvorom pre kľúč			37,00	44,40
kľ./kľ. s PZ otvorom pre vložku			37,00	44,40
kľ./kľ. s WC kľúčom			47,50	57,00
guľa/kľ. s PZ otvorom pre vložku			61,50	73,80

OVERTE
CENU

5
ROKOV ZÁRUKA



72
90
RÔZTEČ

MATERIÁL: ZAMAK

MATERIÁL: MOSADZ



ZLL ZLATÁ
LESKLÁ (L01)



BRM BRONZ
MATNÝ (B03)

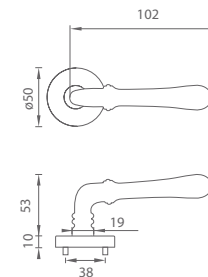
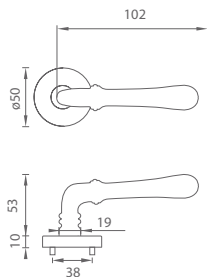

FO - CARINA - R

	Cena za set v €	bez DPH	s DPH
kľ./kľ. bez spodnej rozety		52,00	62,40
kľ./kľ. + rozety BB		62,00	74,40
kľ./kľ. + rozety PZ		62,00	74,40
kľ./kľ. + rozety WC		70,00	84,00
guľa/kľ. + rozety s PZ otvorom		76,00	91,20

OVERTE
CENU



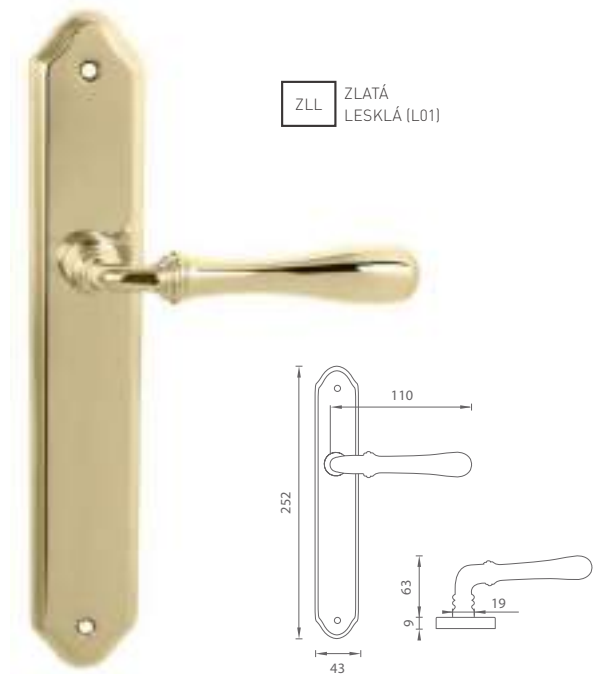

ZLL ZLATÁ
LESKLÁ (L01)

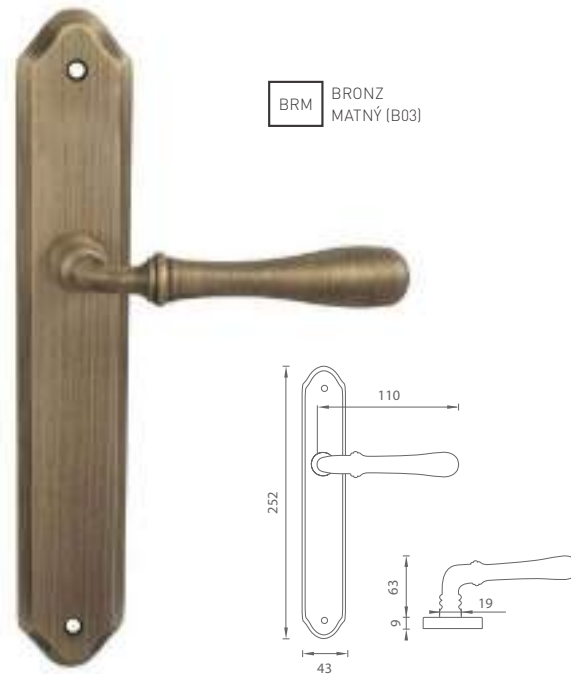





BRM BRONZ
MATNÝ (B03)



OVERTE
CENU

FO - CARINA - SO

		Cena za set v €	bez DPH	s DPH
kľ./kľ. bez otvoru			55,00	66,00
kľ./kľ. s BB otvorom pre kľúč			55,00	66,00
kľ./kľ. s PZ otvorom pre vložku			55,00	66,00
kľ./kľ. s WC kľúčom			65,50	78,60
guľa/kľ. s PZ otvorom pre vložku			95,00	114,00

5
ROKOV ZÁRUKA



72
90
RÔZTEČ

MATERIÁL: MŌSADZ

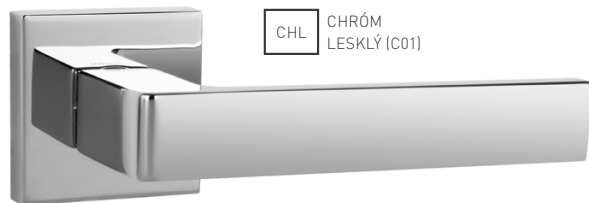

CHL CHRÓM
LESKLÝ (C01)

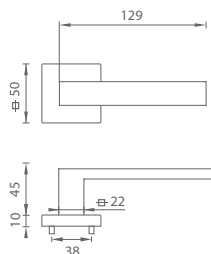

MATERIÁL: ZAMAK

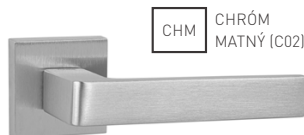

CHM CHRÓM
MATNÝ (C02)



NIM NIKEL
MATNÝ (N16)

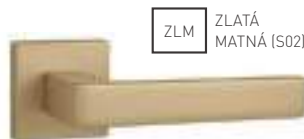

ZLM ZLATÁ
MATNÁ (S02)

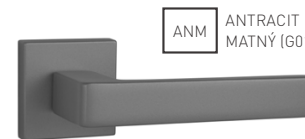

ANM ANTRACIT
MATNÝ (G01)



HNM HNEDÁ
MATNÁ (B11)

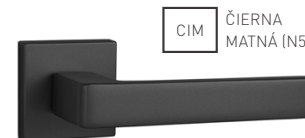

CIM ČIERNA
MATNÁ (N52)



FO - ASTI - HR

	Cena za set v €	bez DPH	s DPH
kľ./kľ. bez spodnej rozety		36,00	43,20
kľ./kľ. + rozety BB		46,00	55,20
kľ./kľ. + rozety PZ		46,00	55,20
kľ./kľ. + rozety WC		55,50	66,60

OVERTE
CENU





CHL CHRÓM
LESKLÝ (C01)

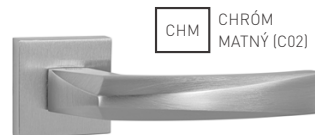
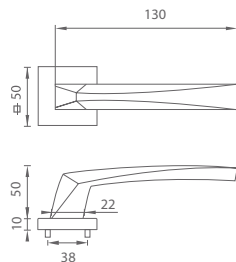

CHM CHRÓM
MATNÝ (C02)



NIM NIKEL
MATNÝ (N16)

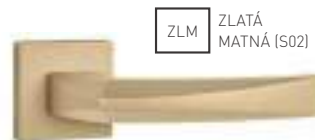

ZLM ZLATÁ
MATNÁ (S02)

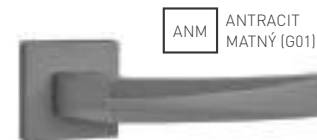

ANM ANTRACIT
MATNÝ (G01)



HNM HNEDÁ
MATNÁ (B11)

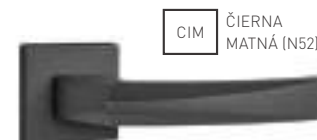

CIM ČIERNA
MATNÁ (N52)

MATERIÁL: ZAMAK



FO - CRYSTAL - HR

	Cena za set v €	bez DPH	s DPH
kľ./kľ. bez spodnej rozety		62,50	75,00
kľ./kľ. + rozety BB		72,50	87,00
kľ./kľ. + rozety PZ		72,50	87,00
kľ./kľ. + rozety WC		82,00	98,40

OVERTE
CENU



5

ROKOV ZÁRUKA



MATERIÁL: ZAMAK



CHL CHRÓM
LESKLÝ (C01)

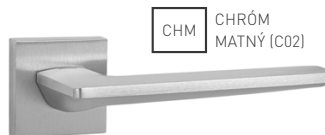
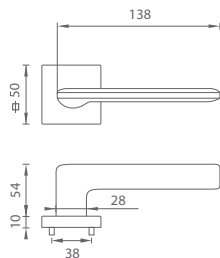

CHM CHRÓM
MATNÝ (C02)

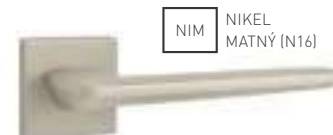

NIM NIKEL
MATNÝ (N16)

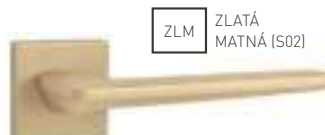

ZLM ZLATÁ
MATNÁ (S02)

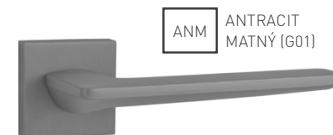

ANM ANTRACIT
MATNÝ (G01)



HNM HNEDÁ
MATNÁ (B11)

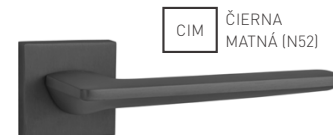

CIM ČIERNA
MATNÁ (N52)



FO - BOSTON - HR

	Cena za set v €	bez DPH	s DPH
kľ./kľ. bez spodnej rozety		65,50	78,60
kľ./kľ. + rozety BB		75,50	90,60
kľ./kľ. + rozety PZ		75,50	90,60
kľ./kľ. + rozety WC		85,00	102,00

OVERTE
CENU





CHL CHRÓM
LESKLÝ (C01)

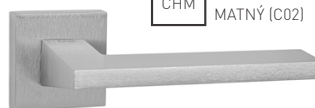
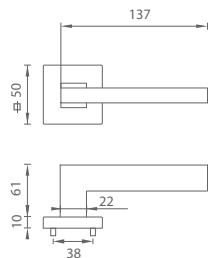

CHM CHRÓM
MATNÝ (C02)

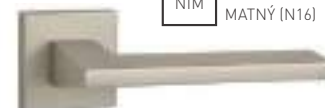

NIM NIKEL
MATNÝ (N16)

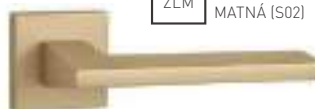

ZLM ZLATÁ
MATNÁ (S02)

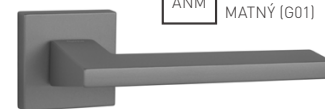

ANM ANTRACIT
MATNÝ (G01)



HNM HNEDÁ
MATNÁ (B11)

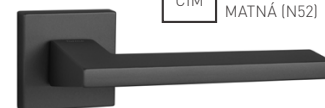

CIM ČIERNA
MATNÁ (N52)

MATERIÁL: ZAMAK



FO - LORENA - HR

	Cena za set v €	bez DPH	s DPH
kľ./kľ. bez spodnej rozety		65,50	78,60
kľ./kľ. + rozety BB		75,50	90,60
kľ./kľ. + rozety PZ		75,50	90,60
kľ./kľ. + rozety WC		85,00	102,00

OVERTE
CENU



MATERIÁL: ZAMAK

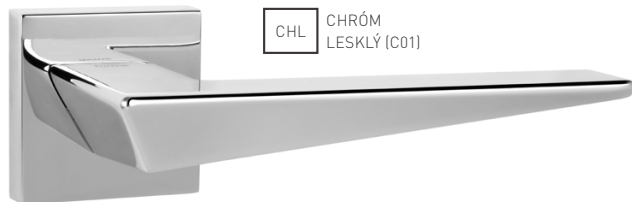

CHL CHRÓM
LESKLÝ (C01)

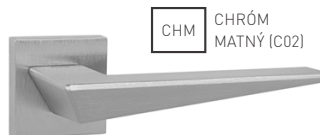
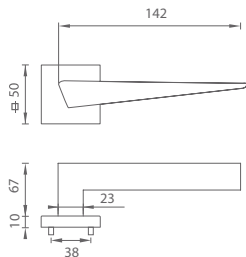

CHM CHRÓM
MATNÝ (C02)

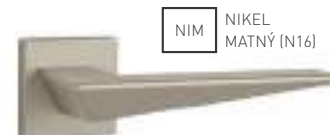

NIM NIKEL
MATNÝ (N16)

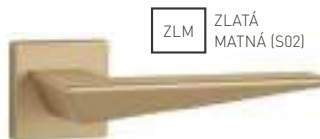

ZLM ZLATÁ
MATNÁ (S02)

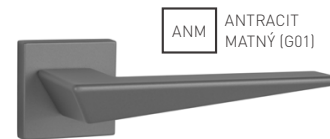

ANM ANTRACIT
MATNÝ (G01)

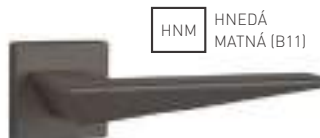

HNM HNEDÁ
MATNÁ (B11)

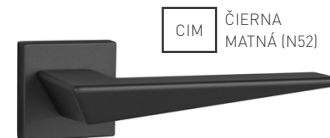

CIM ČIERNA
MATNÁ (N52)



FO - NAXOS - HR

	Cena za set v €	bez DPH	s DPH
kľ./kľ. bez spodnej rozety		65,50	78,60
kľ./kľ. + rozety BB		75,50	90,60
kľ./kľ. + rozety PZ		75,50	90,60
kľ./kľ. + rozety WC		85,00	102,00

OVERTE
CENU





CHL CHRÓM
LESKLÝ (C01)



CHM CHRÓM
MATNÝ (C02)

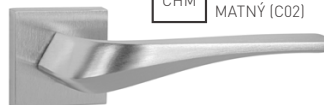

NIM NIKEL
MATNÝ (N16)

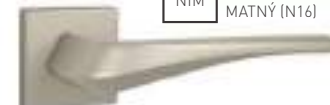

ZLM ZLATÁ
MATNÁ (S02)



ANM ANTRACIT
MATNÝ (G01)

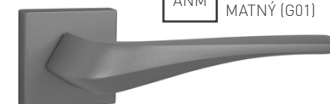

HNM HNEDÁ
MATNÁ (B11)



CIM ČIERNA
MATNÁ (N52)

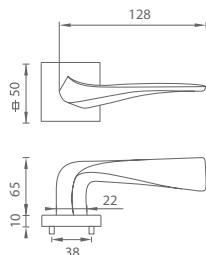
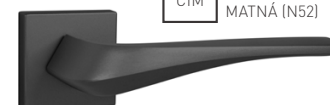

MATERIÁL: ZAMAK



FO - MINERVA - HR

	Cena za set v €	bez DPH	s DPH
kľ./kľ. bez spodnej rozety		65,50	78,60
kľ./kľ. + rozety BB		75,50	90,60
kľ./kľ. + rozety PZ		75,50	90,60
kľ./kľ. + rozety WC		85,00	102,00

OVERTE
CENU



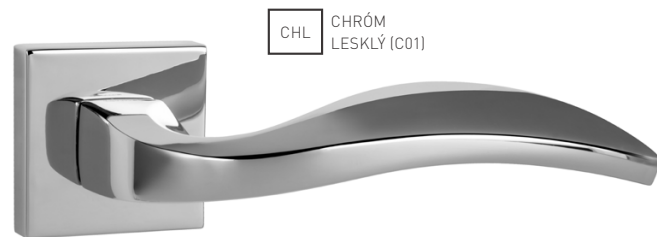

CHL CHRÓM
LESKLÝ (C01)

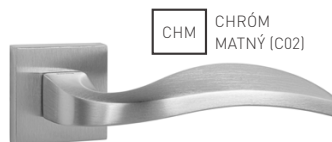
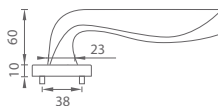
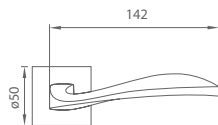

CHM CHRÓM
MATNÝ (C02)

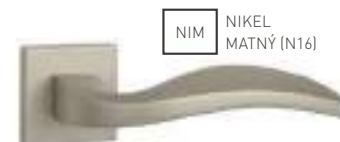

NIM NIKEL
MATNÝ (N16)



ZLM ZLATÁ
MATNÁ (S02)

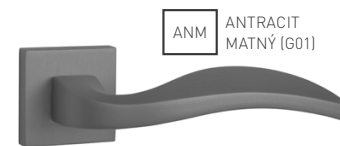

ANM ANTRACIT
MATNÝ (G01)



HNM HNEDÁ
MATNÁ (B11)

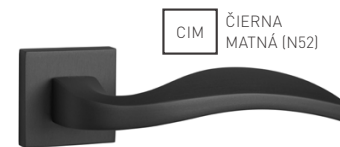

CIM ČIERNA
MATNÁ (N52)

MATERIÁL: ZAMAK



FO - DIANA - HR

	Cena za set v €	bez DPH	s DPH
kľ./kľ. bez spodnej rozety		73,50	88,20
kľ./kľ. + rozety BB		83,50	100,20
kľ./kľ. + rozety PZ		83,50	100,20
kľ./kľ. + rozety WC		93,00	111,60

OVERTE
CENU



MATERIÁL: ZAMAK



BRM BRONZ
MATNÝ (B03)

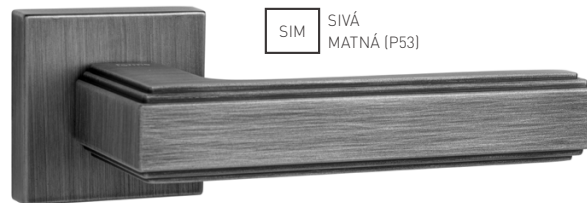

SIM SIVÁ
MATNÁ (P53)

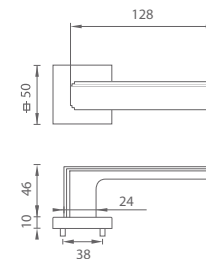
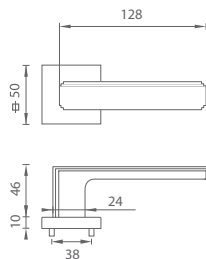

FO - ALILA - HR

	Cena za set v €	bez DPH	s DPH
kľ./kľ. bez spodnej rozety		66,50	79,80
kľ./kľ. + rozety BB		76,50	91,80
kľ./kľ. + rozety PZ		76,50	91,80
kľ./kľ. + rozety WC		86,00	103,20

OVERTE
CENU





BRM BRONZ
MATNÝ (B03)

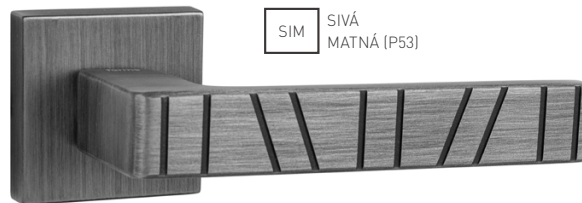

SIM SIVÁ
MATNÁ (P53)

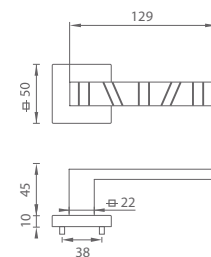
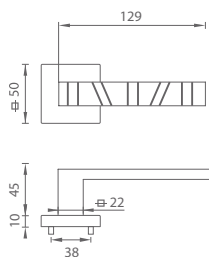

FO - PARIS - HR

	Cena za set v €	bez DPH	s DPH
kľ./kľ. bez spodnej rozety		66,50	79,80
kľ./kľ. + rozety BB		76,50	91,80
kľ./kľ. + rozety PZ		76,50	91,80
kľ./kľ. + rozety WC		86,00	103,20



OVERTE
CENU

MATERIÁL: ZAMAK

NIM NIKEL
MATNÝ (N16)



ZLM ZLATÁ
MATNÁ (S02)



ANM ANTRACIT
MATNÝ (G01)



HNM HNEDÁ
MATNÁ (B11)



CIM ČIERNÁ
MATNÁ (N52)

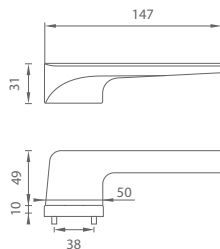

MATERIÁL: ZAMAK

i V prípade PZ setu je použitá PZ rozeta 50 x 40 mm



FO - PENTA - RT

	Cena za set v €	bez DPH	s DPH
kľ./kľ. bez spodnej rozety		85,00	102,00
kľ./kľ. + rozety BB		95,00	114,00
kľ./kľ. + rozety PZ		95,00	114,00
kľ./kľ. + rozety WC		104,50	125,40

**OVERTE
CENU**

5
ROKOV ZÁRUKA



NIM NIKEL
MATNÝ (N16)

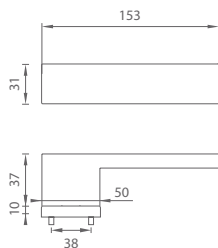

ZLM ZLATÁ
MATNÁ (S02)



HNM HNEDÁ
MATNÁ (B11)



ANM ANTRACIT
MATNÝ (G01)



CIM ČIERNA
MATNÁ (N52)



i V prípade PZ setu je použitá PZ rozeta 50 x 40 mm



FO - ICON - RT

	Cena za set v €	bez DPH	s DPH
kľ./kľ. bez spodnej rozety		80,50	96,60
kľ./kľ. + rozety BB		90,50	108,60
kľ./kľ. + rozety PZ		90,50	108,60
kľ./kľ. + rozety WC		100,00	120,00



OVERTE
CENU

séria **OKENNÉ KOVANIA**

Kľučky na okná a eurookná



OKENNÉ KOVANIA

KĽUČKY NA OKNÁ
A EUROKNÁ



KONŠTRUKCIA KĽUČKY NA EUROOKNO

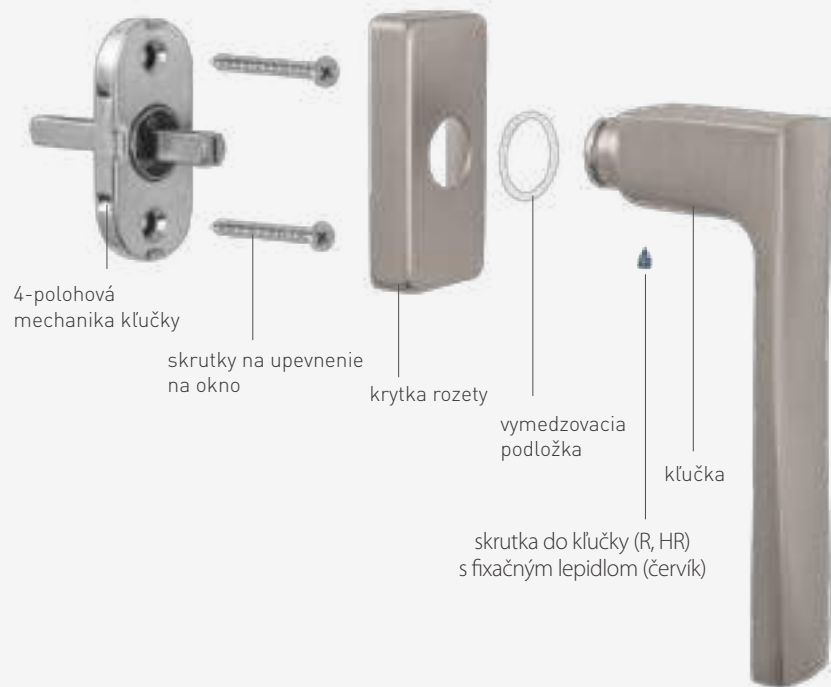

VYSVETLIVKY



predĺžená záruka 3 a 5 rokov



rozeta s výstupkami (zabraňuje nežiadanému pohybu rozety na dverách)



súčasťou balenia sú 2 kusy metrických skrutiek 5 x 40 mm



súčasťou balenia je sada skrutiek na preskrutkovanie cez dvere



súčasťou balenia sú samorezné skrutky v príslušnom počte ku kovaniu



osempolohová mechanika na eurookno

MATERIÁL: HLINÍK



STM STRIEBORNÁ MATNÁ (F1)

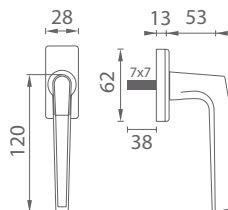

BIM BIELA MATNÁ (B)



NIM NIKEL MATNÝ (F8)



BRM BRONZ MATNÝ (F4)



CIM ČIERNA MATNÁ (N)

i Kľučka na dvere na strane 23



BA - LUCIA - DKH

	STM, BRM		NIM		BIM, CIM	
	bez DPH	s DPH	bez DPH	s DPH	bez DPH	s DPH
kľučka na eurookno	5,60	6,72	6,00	7,20	7,80	9,36



OVERTE
CENU



STM STRIEBORNÁ MATNÁ (F1)

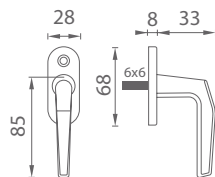

BIM BIELA MATNÁ (B)



NIM NIKEL MATNÝ (F8)



BRM BRONZ MATNÝ (F4)



CIM ČIERNA MATNÁ (N)

MATERIÁL: HLINÍK



OVERTE CENU

BA - LUCIA - POLOLIVA

	STM, BRM		NIM		BIM, CIM	
	bez DPH	s DPH	bez DPH	s DPH	bez DPH	s DPH
okenná pololiva	4,50	5,40	5,00	6,00	7,00	8,40



MATERIÁL: HLINÍK



STM STRIEBORNÁ
MATNÁ (F1)

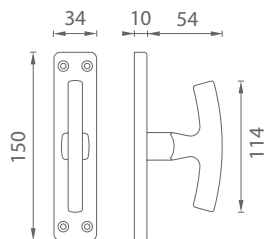

BIM BIELA
MATNÁ (B)



NIM NIKEL
MATNÝ (F8)



BRM BRONZ
MATNÝ (F4)



CIM ČIERNA
MATNÁ (N)



BA - LUCIA - OLIVA

	STM, BRM		NIM		BIM, CIM	
	bez DPH	s DPH	bez DPH	s DPH	bez DPH	s DPH
okenná oliva	7,00	8,40	7,50	9,00	9,00	10,80



OVERTE
CENU



STM STRIEBORNÁ
MATNÁ (F1)

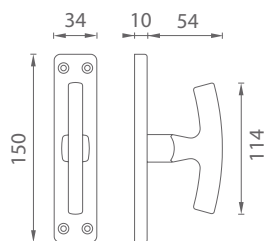

BIM BIELA
MATNÁ (B)



NIM NIKEL
MATNÝ (F8)



BRM BRONZ
MATNÝ (F4)



CIM ČIERNA
MATNÁ (N)

i mechanizmus
pre rozvora



MATERIÁL: HLINÍK



BA - LUCIA - ROZVORA

	STM, BRM		NIM		BIM, CIM	
	bez DPH	s DPH	bez DPH	s DPH	bez DPH	s DPH
okenná rozvora	11,60	13,92	12,10	14,52	13,60	16,32



OVERTE
CENU

MATERIÁL: NEREZ



NEM NEREZ MATNÁ

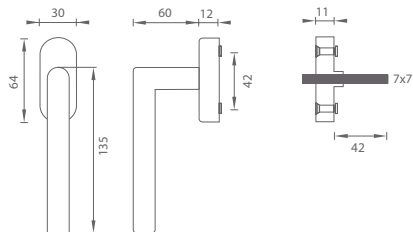

CIM ČIERNAMATNÁ (EB)

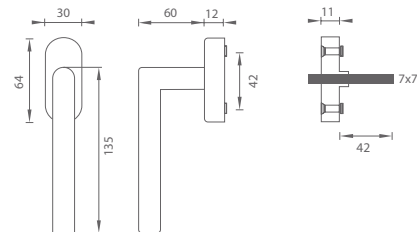

i Kľučka na dvere na strane 40



MP - FAVORIT - DKO

	Cena za kus v €	bez DPH	s DPH
kľučka na eurookno		7,00	8,40



MP - FAVORIT - DKO

	Cena za kus v €	bez DPH	s DPH
kľučka na eurookno		8,00	9,60



OVERTE
CENU



NEM NEREZ MATNÁ

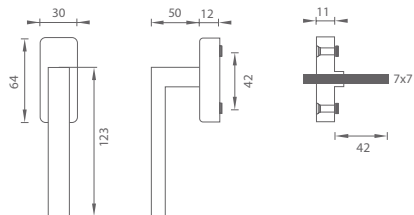

CIM ČIERNÁ MATNÁ (EB)

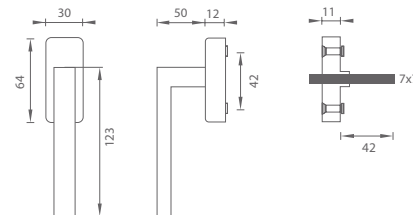

i Kľučka na dvere na strane 53



MP - QUADRA - DKH

	Cena za kus v €	bez DPH	s DPH
klučka na eurookno		9,00	10,80



MP - QUADRA - DKH

	Cena za kus v €	bez DPH	s DPH
klučka na eurookno		10,00	12,00



OVERTE
CENU

MATERIÁL: NEREZ

MATERIÁL: ZAMAK/HLINÍK



NIM NIKEL
MATNÝ (MSN)

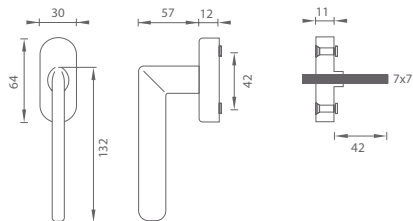

CIM ČIERNA
MATNÁ (EB)

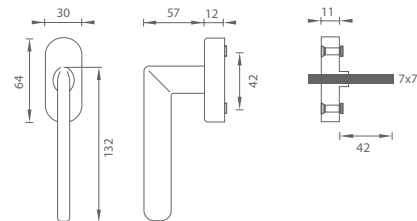

i Kľučka na dvere na strane 96



MP - ELIPTICA - DKO

	Cena za kus v €	bez DPH	s DPH
klučka na eurookno		17,00	20,40



MP - ELIPTICA - DKO

	Cena za kus v €	bez DPH	s DPH
klučka na eurookno		17,00	20,40



OVERTE
CENU



NIM NIKEL
MATNÝ (MSN)

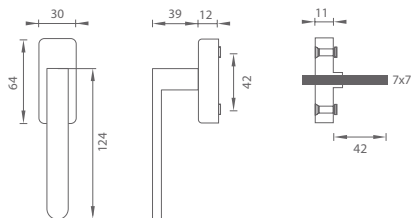

GRM GRAFIT
MATNÝ (MSB)

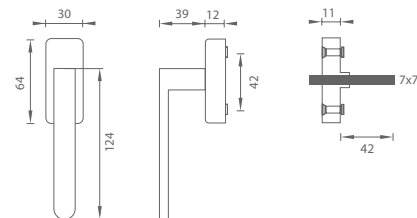

i Kľučka na dvere na strane 120



MP - BISKIT - DKH

	Cena za kus v €	bez DPH	s DPH
klučka na eurookno		17,00	20,40



MP - BISKIT - DKH

	Cena za kus v €	bez DPH	s DPH
klučka na eurookno		17,00	20,40



OVERTE
CENU

MATERIÁL: ZAMAK/HLINÍK

MATERIÁL: ZAMAK/HLINÍK



NIM NIKEL
MATNÝ (MSN)

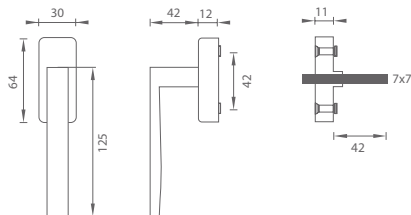

CIM ČIERNA
MATNÁ (EB)

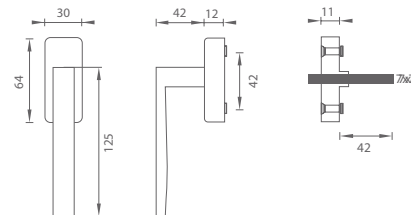

i Kľučka na dvere na strane 98 a 114



MP - HOLLY - DKH

	Cena za kus v €	bez DPH	s DPH
klúčka na eurookno		17,00	20,40



MP - HOLLY - DKH

	Cena za kus v €	bez DPH	s DPH
klúčka na eurookno		17,00	20,40



OVERTE
CENU



NIM NIKEL
MATNÝ (MSN)

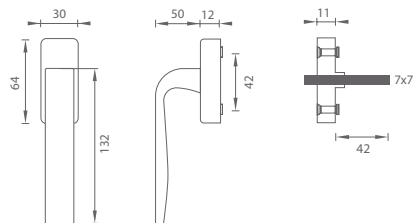

CIM ČIERNÁ
MATNÁ (EB)

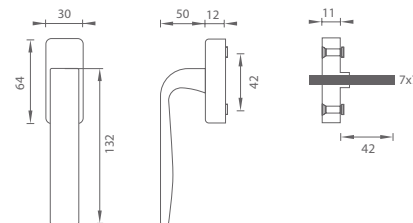

i Kľučka na dvere na strane 102 a 118



MP - CYNTHIA - DKH

	Cena za kus v €	bez DPH	s DPH
klučka na eurookno		17,00	20,40



MP - CYNTHIA - DKH

	Cena za kus v €	bez DPH	s DPH
klučka na eurookno		17,00	20,40



OVERTE
CENU

MATERIÁL: ZAMAK/HLINÍK

MATERIÁL: ZAMAK/HLINÍK



NIM NIKEL
MATNÝ (MSN)

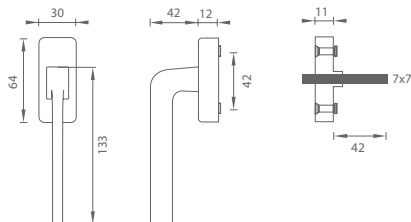

CIM ČIERNA
MATNÁ (EB)

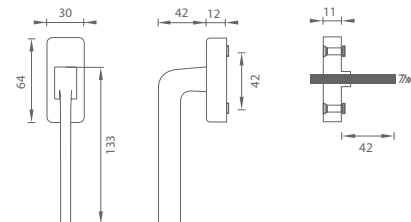

i Kľučka na dvere na strane 100



MP - VIVA - DKH

	Cena za kus v €	bez DPH	s DPH
klúčka na eurookno		17,00	20,40



MP - VIVA - DKH

	Cena za kus v €	bez DPH	s DPH
klúčka na eurookno		17,00	20,40



OVERTE
CENU



CHL CHRÓM
LESKLÝ (CP)

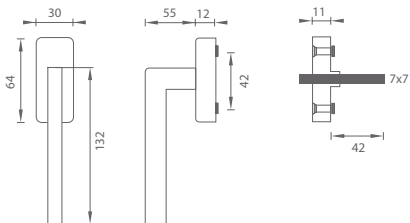

CHM CHRÓM
MATNÝ (MSC)



NIM NIKEL
MATNÝ (MSN)



GRM GRAFIT
MATNÝ (MSB)



CIM ČIERNA
MATNÁ (EB)

i Kľučka na dvere na strane 104



MP - PRIMA - DKH

	CIM, GRM, CHM, NIM		CHL	
	bez DPH	s DPH	bez DPH	s DPH
kľučka na eurookno	17,00	20,40	19,00	22,80

Cena za kus v €



OVERTE
CENU

MATERIÁL: ZAMAK/HLINÍK

MATERIÁL: ZAMAK/HLINÍK



CHL CHRÓM
LESKLÝ (CP)

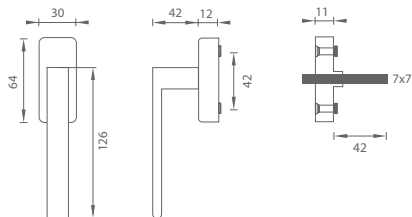

BIM BIELA MATNÁ



CHM CHRÓM
MATNÝ (MSC)



NIM NIKEL
MATNÝ (MSN)



GRM GRAFIT
MATNÝ (MSB)



CIM ČIERNA
MATNÁ (EB)

i Kľučka na dvere na strane 106



MP - HIT - DKH

	BIM, CIM, GRM, CHM, NIM		CHL	
	bez DPH	s DPH	bez DPH	s DPH
kľučka na eurookno	17,00	20,40	19,00	22,80



OVERTE
CENU



BRA BRONZ
ANTIK

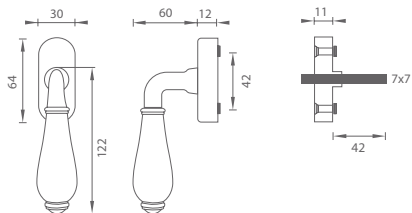

i Kľučka na dvere na strane 132



MP - LEONTINA - DK0

	Cena za kus v €	bez DPH	s DPH
klučka na eurookno		22,00	26,40



OVERTE
CENU

MATERIÁL: ZAMAK/KERAMIKA

MATERIÁL: ZAMAK



CHL CHRÓM
LESKLÝ (CP)

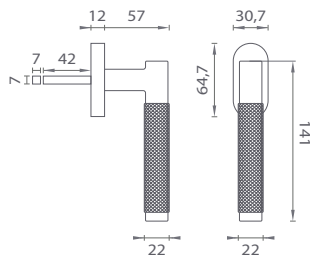

ZLL ZLATÁ LESKLÁ
PVD (GOLD PVD)



ZLM ZLATÁ MATNÁ
(GOLD SATIN)



CIM ČIERNA MATNÁ
(BLACK)

i Kľučka na dvere na strane 218



AT - MOLINIA - DKO 7S

	CHL, CIM		ZLL PVD		ZLM	
	bez DPH	s DPH	bez DPH	s DPH	bez DPH	s DPH
kľučka na eurookno	36,00	43,20	42,00	50,40	44,00	52,80



OVERTE
CENU



MATERIÁL: NEREZ



NEM NEREZ
MATNÁ (16)



CIM ČIERNÁ
MATNÁ (153)

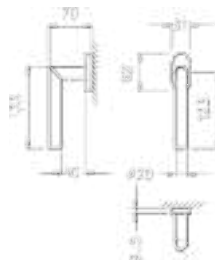

NEM NEREZ
MATNÁ (16)



CIM ČIERNÁ
MATNÁ (153)



i Kľučka na dvere na strane 188



TI - FAVORIT - DKO 2002

	Cena za kus v €	
	bez DPH	s DPH
klúčka na eurookno NEM	19,50	23,40
klúčka na eurookno CIM	28,00	33,60



TI - FAVORIT - DKH 2002Q

	Cena za kus v €	
	bez DPH	s DPH
klúčka na eurookno NEM	19,50	23,40
klúčka na eurookno CIM	36,50	43,80



OVERTE
CENU



CHL CHRÓM
LESKLÝ (03)

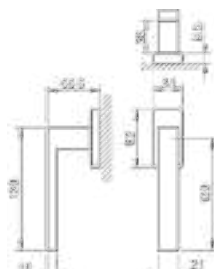

BIM BIELA
MATNÁ (152)



CHM CHRÓM
MATNÝ (96)



NIM NIKEL
MATNÝ (142)



GRM GRAFIT
MATNÝ (141)



CIM ČIERNA
MATNÁ (153)

i Kľučka na dvere na strane 192



TI - SQUARE - DKH 2275Q

	Cena za kus v €	bez DPH	s DPH
klučka na eurookno		37,50	45,00



OVERTE
CENU

MATERIÁL: ZAMAK

MATERIÁL: ZAMAK



CHM CHRÓM
MATNÝ (96)

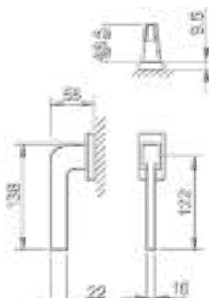

BIM BIELA
MATNÁ (152)



NIM NIKEL
MATNÝ (142)



GRM GRAFIT
MATNÝ (141)



CIM ČIERNA
MATNÁ (153)

i Kľučka na dvere na strane 196



TI - SUPRA - DKH 3097Q

	Cena za kus v €	bez DPH	s DPH
klučka na eurookno		37,50	45,00



OVERTE
CENU



CHM CHRÓM
MATNÝ (96)

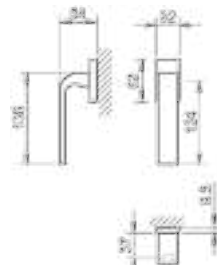

BIM BIELA
MATNÁ (152)



NIM NIKEL
MATNÝ (142)



GRM GRAFIT
MATNÝ (141)



CIM ČIERNA
MATNÁ (153)

i Kľučka na dvere na strane 193



TI - CINTO - DKH 2732Q

	Cena za kus v €	bez DPH	s DPH
klučka na eurookno		38,50	46,20



OVERTE
CENU

MATERIÁL: ZAMAK

MATERIÁL: ZAMAK



CHL CHRÓM
LESKLÝ (03)

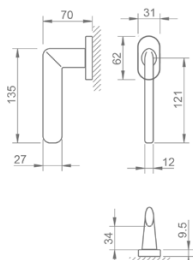

i Kľučka na dvere na strane 190



CHM CHRÓM
MATNÝ (96)



NIM NIKEL
MATNÝ (142)



GRM GRAFIT
MATNÝ (141)



CIM ČIERNA
MATNÁ (153)



TI - ELIPTICA - DKO 3098

	Cena za kus v €	bez DPH	s DPH
klučka na eurookno		41,00	49,20



OVERTE
CENU



CHL CHRÓM
LESKLÝ (03)

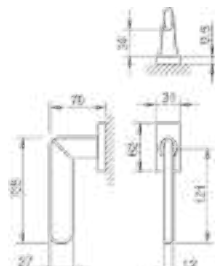

CHM CHRÓM
MATNÝ (96)



NIM NIKEL
MATNÝ (142)



GRM GRAFIT
MATNÝ (141)



CIM ČIERNA
MATNÁ (153)

i Kľučka na dvere na strane 191



TI - ELIPTICA - DKH 3098Q

	Cena za kus v €	bez DPH	s DPH
kľučka na eurookno		43,00	51,60



OVERTE
CENU

MATERIÁL: ZAMAK

MATERIÁL: ZAMAK



CHL CHRÓM
LESKLÝ (C01)



CHM CHRÓM
MATNÝ (C02)



NIM NIKEL
MATNÝ (N16)



ZLM ZLATÁ
MATNÁ (S02)



ANM ANTRACIT
MATNÝ (G01)



HNM HNEDÁ
MATNÁ (B11)



CIM ČIERNA
MATNÁ (N52)

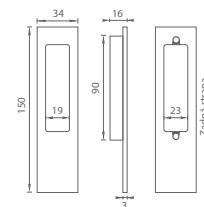
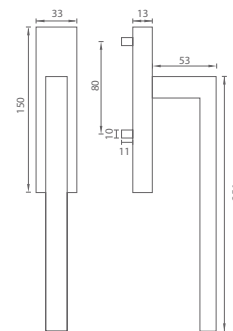

FO - ASTI - HS PORTAL

	Cena za set v €	bez DPH	s DPH
kl./mušľa bez otvoru		108,00	129,60



OVERTE
CENU



CHL CHRÓM
LESKLÝ (C01)



CHM CHRÓM
MATNÝ (C02)



NIM NIKEL
MATNÝ (N16)



ZLM ZLATÁ
MATNÁ (S02)



ANM ANTRACIT
MATNÝ (G01)



HNM HNEDÁ
MATNÁ (B11)



CIM ČIERNA
MATNÁ (N52)

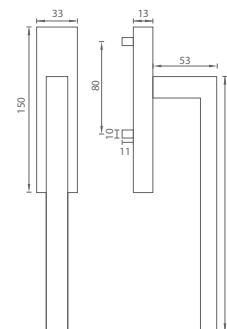

FO - ASTI - HS PORTAL PZ

	Cena za set v €	bez DPH	s DPH
kľ./kľ. s PZ otvorom		207,50	249,00



OVERTE
CENU

MATERIÁL: ZAMAK

séria **BEZPEČNOSTNÉ KOVANIA**

Bezpečnostné kovania, bezpečnostné rozety, menovka s priezorníkom

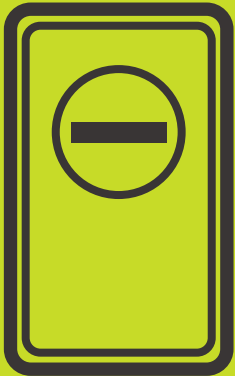

**BEZPEČNOSTNÉ
KOVANIA**



VÝHODY KOVANIA BETA2 PLUS, OMEGA2 PLUS

- predĺžená záruka 10 rokov
- vysoká odolnosť voči opotrebovaniu
- certifikát bezpečnostnej triedy 3 (ČSN EN 1906:2012)
- požiarneho certifikátu (STN EN 1634-1)
- moderný design
- samonastaviteľné prekrytie cylindrickej vložky - FLEX
- pevne ukotvené madlo 2 skrutkami
- ukrytá stredová skrutka
- pravo/ľavé prevedenie
- dostupnosť náhradných dielov a predĺžených skrutiek pre hrubšie dvere

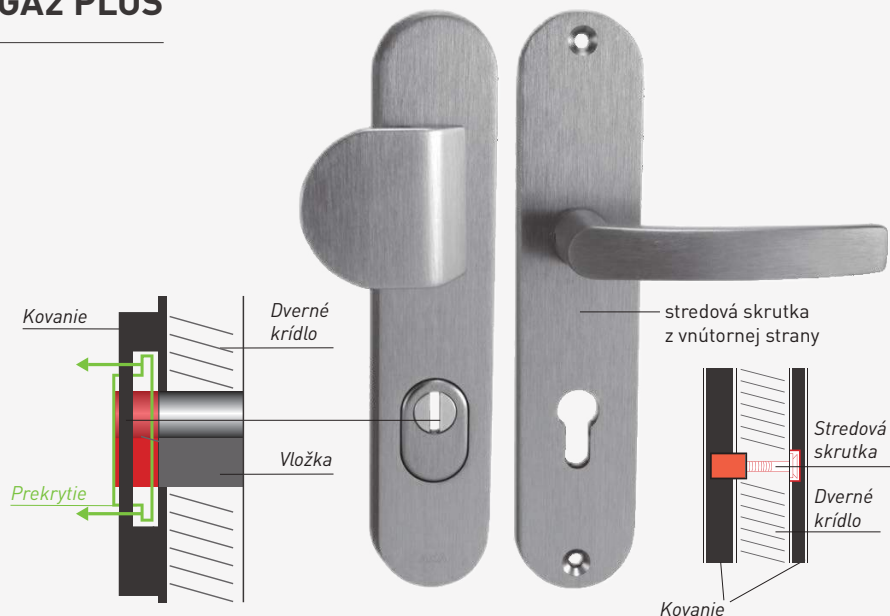

Presah cylindrickej vložky od dverí 10 - 16 mm.

Prekrytie vložky FLEX je samonastaviteľné v rozmedzí 0 - 6 mm.

VYSVETLIVKY



predĺžená záruka 10 rokov



súčasťou balenia je sada skrutiek na preskrutkovanie cez dvere



pre protipožiarne a dymotesné dvere



certifikované kovanie bezpečnostná trieda 3



univerzálna montáž pravo-ľavé prevedenie



rozteč - vzdialenosť medzi osou kľučky a osou kľúča 90 alebo 92 mm



možné montovať aj jednostranne



vhodné do exteriérov - povrchové úpravy odolné voči poveternostným vplyvom



rozteč - vzdialenosť medzi osou kľučky a osou kľúča 72 alebo 90 mm (pre hrúbku dverí od 38 mm do 50 mm) alebo 92 mm (pre hrúbku dverí od 58 mm do 68 mm)

MATERIÁL: HLINÍK



NEM NEREZ
MATNÁ (F6)



CIM ČIERNÁ
MATNÁ (F9)

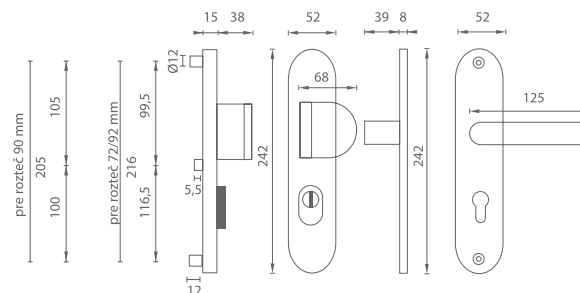

Kovanie s roztečou 72 a 90 mm je štandardom pre hrúbku dverí od 38 mm do 50 mm.
Kovanie s roztečou 92 mm je štandardom pre hrúbku dverí od 68 mm do 78 mm.



AXA - BETA 2 PLUS - SO

Cena za set v €	NEM		CIM	
	bez DPH	s DPH	bez DPH	s DPH
kľ./kľ. PLUS s PZ otvorom	69,00	82,80	79,40	95,28
madlo/kľ. PLUS s PZ otvorom	69,50	83,40	79,90	95,88

**OVERTE
CENU**

UPOZORNENIE: v prípade neštandardnej hrúbky dverí pri danej rozteči je potrebné uviesť hrúbku dverí





NEM NEREZ
MATNÁ (F6)



CIM ČIERNÁ
MATNÁ (F9)



95 mm

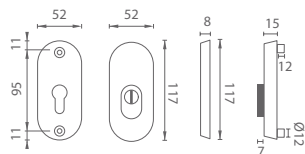

105 mm

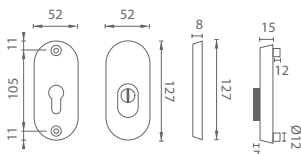

Prídavné rozety sú štandardom pre hrúbku dverí od 38 mm do 50 mm.



NEM NEREZ
MATNÁ (F6)



CIM ČIERNÁ
MATNÁ (F8)

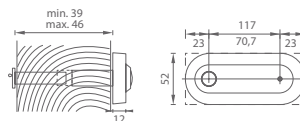

Otvor pre priezorník: Ø14 mm
Možnosť predĺženia priezorníka o 10 mm - str. 448

MATERIÁL: HLINÍK



AXA - ROZETA BETA 2 PLUS - OR

	Cena za set v €	bez DPH	s DPH
rozeta 95* PLUS s PZ otvorom NEM		35,70	42,84
rozeta 105* PLUS s PZ otvorom NEM		35,70	42,84
rozeta 95* PLUS s PZ otvorom CIM		41,00	49,20
rozeta 105* PLUS s PZ otvorom CIM		41,00	49,20

OVERTE
CENU

* 95 resp. 105 označuje osovú vzdialenosť otvorov pre skrutky

10



AXA - MENOVKA S PRIEZORNÍKOM BETA 2

	Cena za set v €	bez DPH	s DPH
menovka s priezorníkom Beta 2 - NEM		27,50	33,00
menovka s priezorníkom Beta 2 - CIM		30,20	36,24

10



MATERIÁL: HLINÍK



NEM NEREZ
MATNÁ (F6)



CIM ČIERNÁ
MATNÁ (F9)

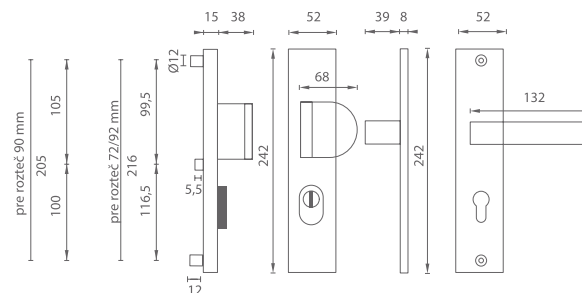

Kovanie s roztečou 72 a 90 mm je štandardom pre hrúbku dverí od 38 mm do 50 mm.
Kovanie s roztečou 92 mm je štandardom pre hrúbku dverí od 68 mm do 78 mm.



AXA - OMEGA 2 PLUS - SH

Cena za set v €	NEM		CIM	
	bez DPH	s DPH	bez DPH	s DPH
kľ./kľ. PLUS s PZ otvorom	70,10	84,12	80,60	96,72
madlo/kľ. PLUS s PZ otvorom	70,70	84,84	81,40	97,68

**OVERTE
CENU**

UPOZORNENIE: v prípade neštandardnej hrúbky dverí pri danej rozteči je potrebné uviesť hrúbku dverí





NEM NEREZ
MATNÁ (F6)



CIM ČIERNA
MATNÁ (F9)



95 mm

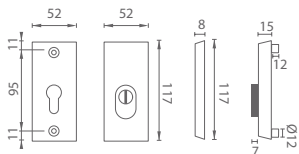

105 mm

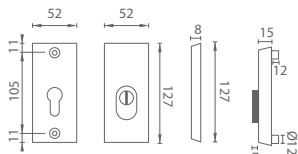

Prídavné rozety sú štandardom pre hrúbku dverí od 38 mm do 50 mm.
Produkt vhodný aj pre kovanie Omega 2 PLUS.

ATLAS 2 / OMEGA 2



NEM NEREZ MATNÁ (F6)



CIM ČIERNA MATNÁ
(F8)

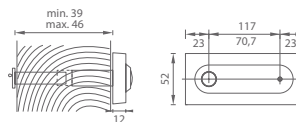

Otvor pre priezorník: Ø14 mm
Možnosť predĺženia priezorníka o 10 mm - str. 448

MATERIÁL: HLINÍK



AXA - ROZETA ATLAS 2 PLUS/OMEGA 2 PLUS - HR

	Cena za set v €	
	bez DPH	s DPH
rozeta 95* PLUS s PZ otvorom NEM	35,70	42,84
rozeta 105* PLUS s PZ otvorom NEM	35,70	42,84
rozeta 95* PLUS s PZ otvorom CIM	41,00	49,20
rozeta 105* PLUS s PZ otvorom CIM	41,00	49,20

OVERTE
CENU

* 95 resp. 105 označuje osovú vzdialenosť otvorov pre skrutky



AXA - MENOVKA S PRIEZORNÍKOM ATLAS 2/OMEGA 2

	Cena za set v €	
	bez DPH	s DPH
menovka s priezorníkom Atlas 2 - NEM	27,50	33,00
menovka s priezorníkom Omega 2 - CIM	30,20	36,24



MATERIÁL: ZAMAK



i Pri prevedení kľučka/kľučka je dostupná rozteč 72 a 92 mm



TI - FORTE PLUS/SQUARE 3214/2275 - SH

	Cena za set v €	bez DPH	s DPH
kl./kľ. s PZ otvorom pre vložku (rozteč 72 a 92)	140,00	140,00	168,00
madlo/kľ. s PZ otvorom pre vložku	140,00	140,00	168,00

OVERTE
CENU



72/90
92
ROZTEČ

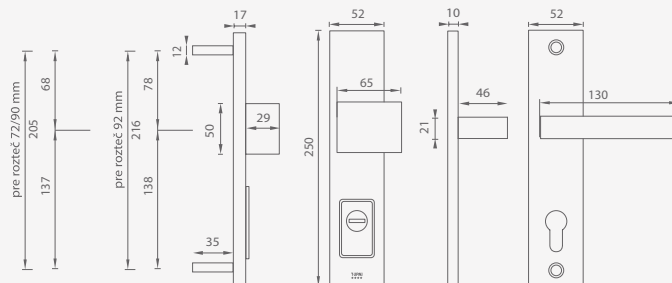

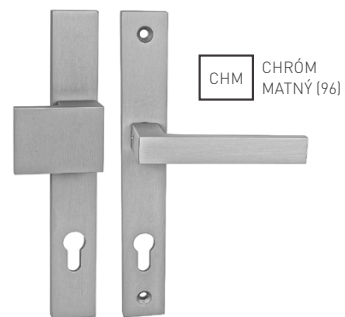

TI - SALVO/SQUARE 3199/2275 - SHU

	Cena za set v €	bez DPH	s DPH
kľ./kľ. s PZ otvorom pre vložku		60,00	72,00
madlo/kľ. s PZ otvorom pre vložku		60,00	72,00

OVERTE
CENU

5
ROKOV ZÁRUKA



72|90
92
RÔZTEC

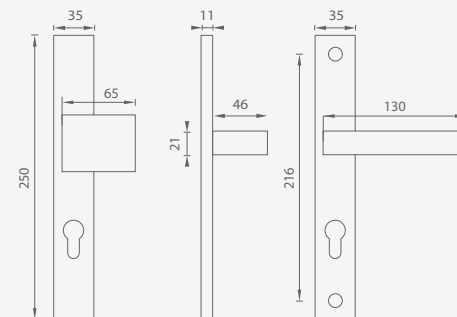

MATERIÁL: ZAMAK

MATERIÁL: MOSADZ



CHM CHRÓM
MATNÝ (96)



NIM NIKEL
MATNÝ (142)

GRM GRAFIT
MATNÝ (141)

CIM ČIERNA
MATNÁ (153)



TI - CUBO/NELA - R 3233/4158

	Cena za set v €	
	bez DPH	s DPH
kl./kl. s PZ otvorom pre vložku	135,00	162,00
guľa./kl. s PZ otvorom pre vložku	132,50	159,00
bezpečnostná rozeta	85,00	102,00

OVERTE
CENU

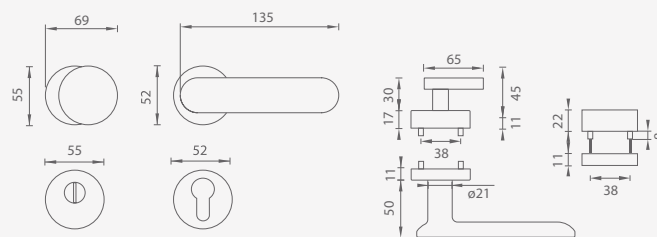



NIM NIKEL
MATNÝ (142)

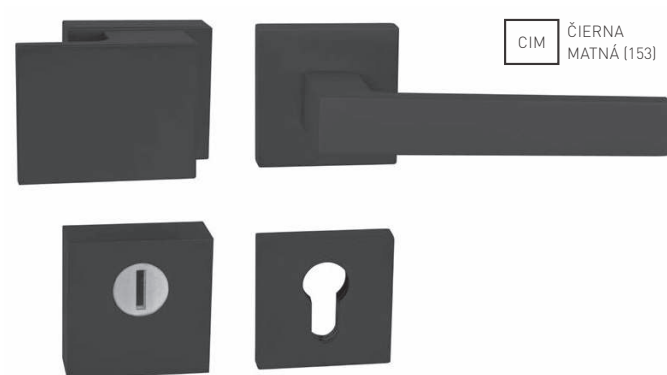

CIM ČIERNA
MATNÁ (153)



TI - CUBO/SQUARE - HR 3230/2275

	Cena za set v €	
	bez DPH	s DPH
kl./kl. s PZ otvorom pre vložku	135,00	162,00
madlo./kl. s PZ otvorom pre vložku	147,50	177,00
bezpečnostná rozeta	85,00	102,00

OVERTE
CENU

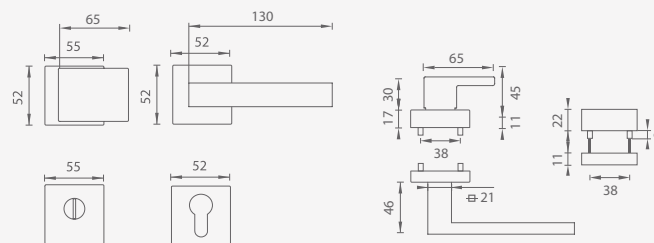

MATERIÁL: ZAMAK



CHM CHRÓM
MATNÝ



NIM NIKEL
MATNÝ

MATERIÁL: HLINÍK

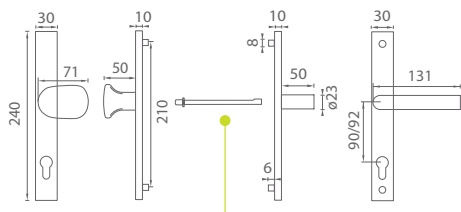

i Štandardná rozteč kovania je 92 mm.
Alternatívnu rozteč 90 mm získame otočením štvorhranu 6 x 8 mm o 90°. Štvorhran 6 x 8 mm je súčasťou balenia.



WA - FELIX 2 - SHU

	CHM		NIM	
	bez DPH	s DPH	bez DPH	s DPH
kľ./kľ. s PZ otvorom (90 a 92 mm)	46,50	55,80	50,00	60,00
madlo/kľ. s PZ otvorom (90 a 92 mm)	46,50	55,80	50,00	60,00
ma./ma. otočné s PZ otvorom (90 a 92 mm)	46,50	55,80	50,00	60,00

OVERTE
CENU





STM STRIEBORNÁ MATNÁ (RAL 9006)



BIL BIELA LESKLÁ (RAL 9016)



ZLM ZLATÁ MATNÁ (RAL 1036)



HNM HNEDÁ MATNÁ (RAL 8017)

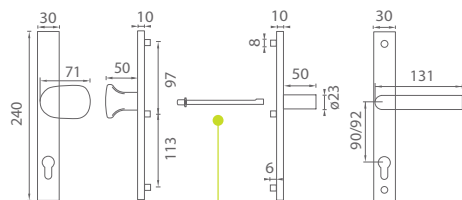

i Štandardná rozteč kovania je **92 mm**.
Alternatívnu rozteč **90 mm** získame otočením štvorhranu **6 x 8 mm** o **90°**. Štvorhran 6 x 8 mm je súčasťou balenia.



HNM.T HNEDÁ MATNÁ TMAVÁ (RAL 8019)



GRS GRAFIT ŠTRUKTÚROVANÝ (RAL 7021)



CIS ČIERNA ŠTRUKTUROVANÁ (RAL 9005)

MATERIÁL: HLINÍK



WA - FELIX 3 - SHU

	BIL, HNM, STM		CIS, GRS, ZLM	
	bez DPH	s DPH	bez DPH	s DPH
kľ./kľ. s PZ otvorom (90 a 92 mm)	26,50	31,80	28,00	33,60
madlo/kľ. s PZ otvorom (90 a 92 mm)	26,50	31,80	28,00	33,60
ma./ma. otočné s PZ otvorom (90 a 92 mm)	26,50	31,80	28,00	33,60

OVERTE
CENU



MATERIÁL: HLINÍK



CHM CHRÓM
MATNÝ

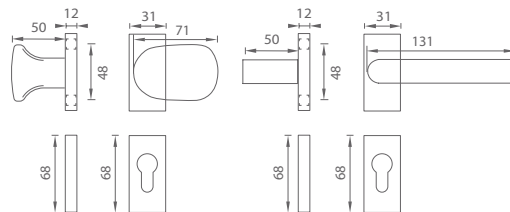

NIM NIKEL
MATNÝ

5
ROKOV ZÁRUKA



WA - FELIX - UHR

	CHM		NIM	
	bez DPH	s DPH	bez DPH	s DPH
Cena za set v €				
kľ./kľ. bez spodnej rozety	44,50	53,40	48,00	57,60
kľ./kľ. + rozety PZ	59,00	70,80	64,00	76,80
madlo/kľ. bez spodnej rozety	44,50	53,40	48,00	57,60
madlo/kľ. + rozety PZ	59,00	70,80	64,00	76,80

OVERTE
CENU



STM STRIEBORNÁ MATNÁ
(RAL 9006)



BIL BIELA LESKLÁ
(RAL 9016)



ZLM ZLATÁ MATNÁ
(RAL 1036)



HNM HNEDÁ MATNÁ
(RAL 8017)



HNM.T HNEDÁ MATNÁ TMAVÁ
(RAL 8019)



GRS GRAFIT ŠTRUKTÚROVANÝ
(RAL 7021)



CIS ČIERNA ŠTRUKTUROVANÁ
(RAL 9005)



WA - FELIX - UHR

	BIL, STM, HNM, HNM.T		CIS, GRS, ZLM	
	bez DPH	s DPH	bez DPH	s DPH
kľ./kľ. bez spodnej rozety	24,50	29,40	26,00	31,20
kľ./kľ. + rozety PZ	31,50	37,80	34,50	41,40
madlo/kľ. bez spodnej rozety	24,50	29,40	26,00	31,20
madlo/kľ. + rozety PZ	31,50	37,80	34,50	41,40

OVERTE
CENU



MATERIÁL: HLINÍK

MATERIÁL: HLINÍK



CHM CHRÓM
MATNÝ

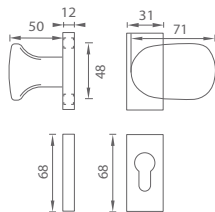

NIM NIKEL
MATNÝ



WA - MADLO FELIX - UHR

	CHM		NIM	
	bez DPH	s DPH	bez DPH	s DPH
madlo pevné/pevné + rozety PZ	59,50	71,40	64,00	76,80
madlo otočné/otočné + rozety PZ	59,50	71,40	64,00	76,80
madlo pevné/otočné + rozety PZ	61,50	73,80	66,00	79,20

OVERTE
CENU



5
ROKOV ZÁRUKA





BIL BIELA LESKLÁ
(RAL 9016)



ZLM ZLATÁ MATNÁ
(RAL 1036)



HNM HNEDÁ MATNÁ
(RAL 8017)



STM STRIEBORNÁ MATNÁ
(RAL 9006)



HNMT HNEDÁ MATNÁ TMAVÁ
(RAL 8019)



GRS GRAFIT ŠTRUKTÚROVANÝ
(RAL 7021)



CIS ČIERNA ŠTRUKTUROVANÁ
(RAL 9005)

MATERIÁL: HLINÍK



WA - MADLO FELIX - UHR

	BIL, STM, HNM, HNM.T		CIS, GRS, ZLM	
	bez DPH	s DPH	bez DPH	s DPH
madlo pevné/pevné + rozety PZ	32,00	38,40	34,50	41,40
madlo otočné/otočné + rozety PZ	32,00	38,40	34,50	41,40
madlo pevné/otočné + rozety PZ	34,00	40,80	36,50	43,80

OVERTE
CENU

3
ROKY ZÁRUKA



séria **DOPLNKY**

Dverné madlá, mušle na posuvné dvere, posuvné systémy, závesy, zámky, zarážky, stavače, zástrče, dverné prahy, tesniace lišty, samozatvárače, panikové kovania, okopové plechy, vetracie mriežky, priezorníky, číslice, uzamykacie systémy, kovania na sklo



DOPLNKY
DVERNÉ MADLÁ

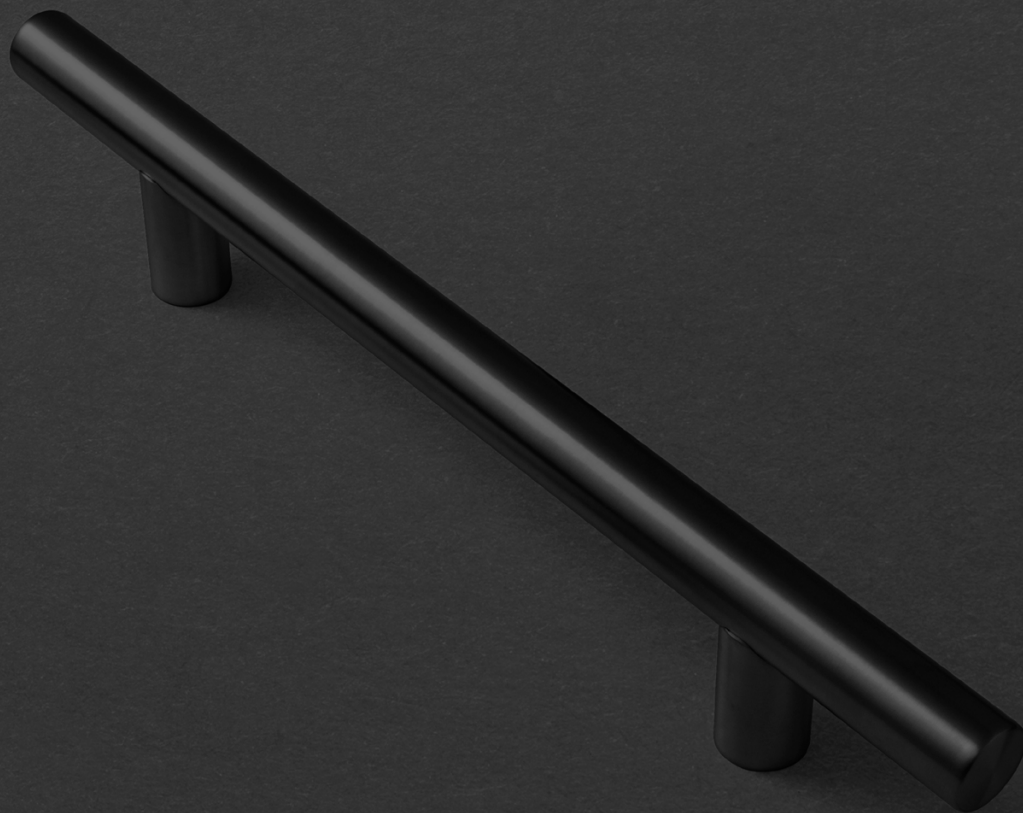



VYSVETLIVKY



predĺžená záruka 3 a 5 rokov



vhodné do exteriérov - povrchové úpravy odolné voči
poveternostným vplyvom [slnko, voda, mráz]

FT - SPOJOVACÍ MATERIÁL ŠTANDARD (ST) / KUS

Spojovací materiál pre jednostrannú montáž jedného madla do masívneho DREVA.

 Pre kus DREVO

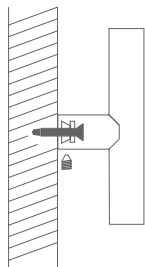

Obsah balenia:



pre
DREVO

 Spojovací materiál je súčasťou každého madla

FT - SPOJOVACÍ MATERIÁL UNIVERZÁL (UN) / KUS

Spojovací materiál pre obojstrannú montáž jedného madla do DREVA, PVC, AL, SKLA.

 Pre kus DREVO, PVC, AL

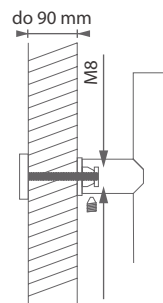



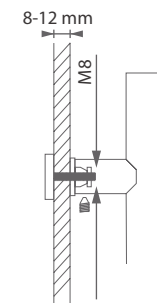



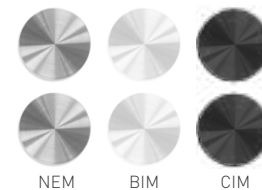





 Pre kus SKLO



Obsah balenia:



FT - SPOJOVACÍ MATERIÁL

	Cena za set v €	NEM		BIM, CIM	
		bez DPH	s DPH	bez DPH	s DPH
FT - UNIVERZÁL (UN) / kus  	 	13,50	16,20	16,00	19,20
FT - ŠPECIÁL (SP) / kus  	 	6,50	7,80	-	-
FT - UNIVERZÁL (UN) / pár  	 	5,00	6,00	-	-

OVERTE
CENU

FT - SPOJOVACÍ MATERIÁL ŠPECIÁL (SP) / KUS

Spojovací materiál pre jednostrannú montáž jedného madla do masívneho DREVA, PVC, AL.

 Pre kus DREVO

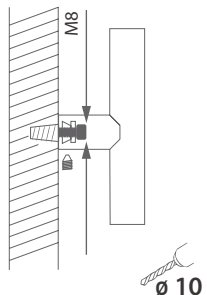

 Pre kus PVC, AL

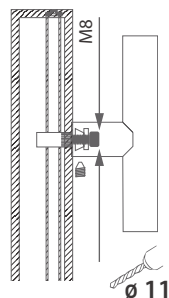

Obsah balenia:



pre
DREVO



pre
DREVO,
PVC, AL



pre
PVC, AL*

* nutné použiť nitovacie kliešte

FT - SPOJOVACÍ MATERIÁL UNIVERZÁL (UN) / PÁR

Spojovací materiál pre obojstrannú montáž dvoch madiel do DREVA, PVC, AL, SKLA.

 Pre pár DREVO, PVC, AL

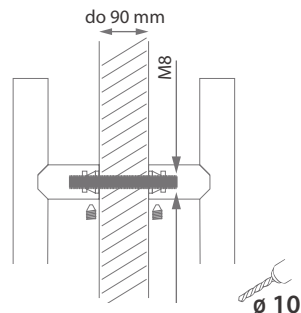

 Pre pár SKLO

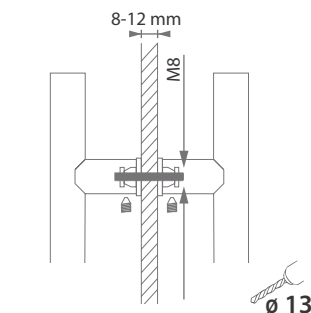

Obsah balenia:









pre
SKLO



pre
DREVO,
PVC, AL



FT - SPOJOVACÍ MATERIÁL

	Cena za set v €	NEM		BIM, CIM	
		bez DPH	s DPH	bez DPH	s DPH
FT - UNIVERZÁL (UN) / kus 		13,50	16,20	16,00	19,20
FT - ŠPECIÁL (SP) / kus 		6,50	7,80	-	-
FT - UNIVERZÁL (UN) / pár 		5,00	6,00	-	-

OVERTE
CENU

MATERIÁL: NEREZ



NEM NEREZ MATNÁ

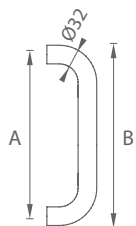

FT - K01/Ø32 - MADLO

dĺžka (B)	rozteč (A)	Cena v €	jedostranná montáž jedného madla DREVO		jedostranná montáž jedného madla DREVO, PVC, AL		obojustranná montáž jedného madla DREVO, PVC, AL, SKLO		obojustranná montáž dvoch madiel DREVO, PVC, AL, SKLO	
			SET (ST) / KUS	SET (SP) / KUS	SET (UN) / KUS	SET (UN) / PÁR				
382 mm	350 mm	NEM	bez DPH	s DPH	bez DPH	s DPH	bez DPH	s DPH	bez DPH	s DPH
			39,50	47,40	46,00	55,20	53,00	63,60	84,00	100,80

OVERTE CENU

i Spojovací materiál je súčasťou balenia.

5





BIM BIELA
MATNÁ

CIM ČIERNA
MATNÁ

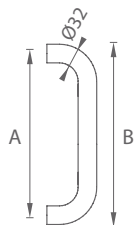

FT - K01/Ø32 - MADLO

dĺžka (B)	rozteč (A)	Cena v €	jedostranná montáž jedného madla DREVO		jedostranná montáž jedného madla DREVO, PVC, AL		obojustranná montáž jedného madla DREVO, PVC, AL, SKLO		obojustranná montáž dvoch madiel DREVO, PVC, AL, SKLO	
			SET (ST) / KUS	SET (SP) / KUS	SET (UN) / KUS	SET (UN) / PÁR				
			bez DPH	s DPH	bez DPH	s DPH	bez DPH	s DPH	bez DPH	s DPH
382 mm	350 mm	BIM, CIM	69,50	83,40	76,00	91,20	83,00	99,60	144,00	172,80

OVERTE
CENU

5
ROKOV ZÁRUKA

MATERIÁL: NEREZ

i Spojovací materiál je súčasťou balenia.



NEM NEREZ MATNÁ



FT - K14T/Ø32 - MADLO

dĺžka (B)	rozteč (A)	Cena v €	jedostranná montáž jedného madla DREVO		jedostranná montáž jedného madla DREVO, PVC, AL		obojustranná montáž jedného madla DREVO, PVC, AL, SKLO		obojustranná montáž dvoch madiel DREVO, PVC, AL, SKLO	
			SET (ST) / KUS	SET (SP) / KUS	SET (UN) / KUS	SET (UN) / PÁR				
			bez DPH	s DPH	bez DPH	s DPH	bez DPH	s DPH	bez DPH	s DPH
382 mm	350 mm	NEM	50,00	60,00	56,50	67,80	63,50	76,20	105,00	126,00

OVERTE
CENU

5

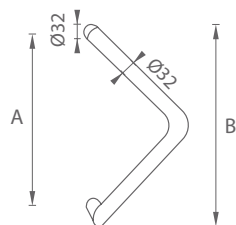

i Spojovací materiál je súčasťou balenia.



BIM BIELA
MATNÁ

CIM ČIERNA
MATNÁ

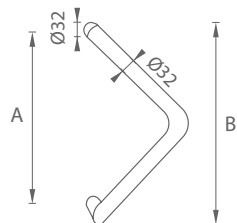

FT - K14T/Ø32 - MADLO

dĺžka (B)	rozteč (A)	Cena v €	jedostranná montáž jedného madla DREVO		jedostranná montáž jedného madla DREVO, PVC, AL		obojustranná montáž jedného madla DREVO, PVC, AL, SKLO		obojustranná montáž dvoch madiel DREVO, PVC, AL, SKLO	
			SET (ST) / KUS	SET (SP) / KUS	SET (UN) / KUS	SET (UN) / PÁR				
			bez DPH	s DPH	bez DPH	s DPH	bez DPH	s DPH	bez DPH	s DPH
382 mm	350 mm	BIM, CIM	79,50	95,40	86,00	103,20	95,50	114,60	164,00	196,80

OVERTE
CENU

5
ROKOV ZÁRUKA

MATERIÁL: NEREZ

i Spojovací materiál je súčasťou balenia.

MATERIÁL: NEREZ



NEM NEREZ MATNÁ

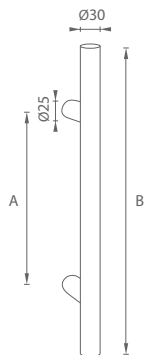

OVERTE
CENU

FT - K00/Ø30 - MADLO			jedostranná montáž jedného madla DREVO		jedostranná montáž jedného madla DREVO, PVC, AL		obojostranná montáž jedného madla DREVO, PVC, AL, SKLO		obojostranná montáž dvoch madiel DREVO, PVC, AL, SKLO	
			SET (ST) / KUS		SET (SP) / KUS		SET (UN) / KUS		SET (UN) / PÁR	
dĺžka (B)	rozteč (A)	Cena v €	bez DPH	s DPH	bez DPH	s DPH	bez DPH	s DPH	bez DPH	s DPH
300 mm	210 mm	NEM	33,50	40,20	40,00	48,00	47,00	56,40	72,00	86,40
400 mm	300 mm	NEM	37,00	44,40	43,50	52,20	50,50	60,60	79,00	94,80
500 mm	300 mm	NEM	39,50	47,40	46,00	55,20	53,00	63,60	84,00	100,80
600 mm	400 mm	NEM	41,50	49,80	48,00	57,60	55,00	66,00	88,00	105,60
800 mm	600 mm	NEM	52,50	63,00	59,00	70,80	66,00	79,20	110,00	132,00
1000 mm	700 mm	NEM	61,00	73,20	67,50	81,00	74,50	89,40	127,00	152,40
1200 mm	900 mm	NEM	73,00	87,60	79,50	95,40	86,50	103,80	151,00	181,20
1500 mm	1300 mm	NEM	78,50	94,20	85,00	102,00	92,00	110,40	162,00	194,40
*1600 mm	1300 mm	NEM	122,50	147,00	135,50	162,60	149,50	179,40	255,00	306,00
*1800 mm	1500 mm	NEM	136,50	163,80	149,50	179,40	163,50	196,20	283,00	339,60
*2000 mm	1800 mm	NEM	142,50	171,00	155,50	186,60	169,50	203,40	295,00	354,00

* madlo s 3 úchytní

i Spojovací materiál je súčasťou balenia.

5
ROKOV ZÁRUKA



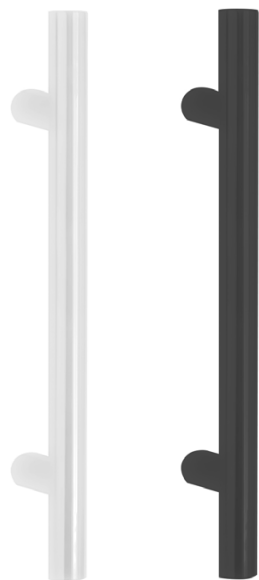

BIM BIELA
MATNÁ

CIM ČIERNÁ
MATNÁ

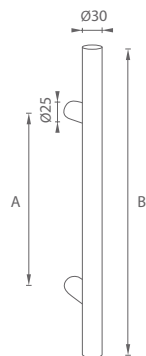

OVERTE
CENU

FT - K00/Ø30 - MADLO			jedostranná montáž jedného madla DREVO		jedostranná montáž jedného madla DREVO, PVC, AL		obojustranná montáž jedného madla DREVO, PVC, AL, SKLO		obojustranná montáž dvoch madiel DREVO, PVC, AL, SKLO	
			SET (ST) / KUS		SET (SP) / KUS		SET (UN) / KUS		SET (UN) / PÁR	
dĺžka (B)	rozteč (A)	Cena v €	bez DPH	s DPH	bez DPH	s DPH	bez DPH	s DPH	bez DPH	s DPH
300 mm	210 mm	BIM, CIM	63,50	76,20	70,00	84,00	79,50	95,40	132,00	158,40
400 mm	300 mm	BIM, CIM	67,00	80,40	73,50	88,20	83,00	99,60	139,00	166,80
500 mm	300 mm	BIM, CIM	69,50	83,40	76,00	91,20	85,50	102,60	144,00	172,80
600 mm	400 mm	BIM, CIM	71,50	85,80	78,00	93,60	87,50	105,00	148,00	177,60
800 mm	600 mm	BIM, CIM	82,50	99,00	89,00	106,80	98,50	118,20	170,00	204,00
1000 mm	700 mm	BIM, CIM	109,00	130,80	115,50	138,60	125,00	150,00	223,00	267,60
1200 mm	900 mm	BIM, CIM	121,00	145,20	127,50	153,00	137,00	164,40	247,00	296,40
1500 mm	1300 mm	BIM, CIM	153,50	184,20	160,00	192,00	169,50	203,40	312,00	374,40
*1600 mm	1300 mm	BIM, CIM	197,00	236,40	210,00	252,00	229,00	274,80	404,00	484,80
*1800 mm	1500 mm	BIM, CIM	211,50	253,80	224,50	269,40	243,50	292,20	433,00	519,60
*2000 mm	1800 mm	BIM, CIM	217,50	261,00	230,50	276,60	249,50	299,40	445,00	534,00

* madlo s 3 úchytni

i Spojovací materiál je súčasťou balenia.

5
ROKOV ZÁRUKA

MATERIÁL: NEREZ

MATERIÁL: NEREZ



NEM NEREZ MATNÁ

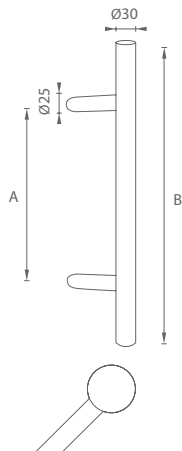

OVERTE
CENU

**FT - K10/Ø30 -
MADLO**

dĺžka (B)	rozteč (A)	Cena v €	jedostranná montáž jedného madla DREVO		jedostranná montáž jedného madla DREVO, PVC, AL		obojsstranná montáž jedného madla DREVO, PVC, AL, SKLO		obojsstranná montáž dvoch madiel DREVO, PVC, AL, SKLO	
			SET (ST) / KUS		SET (SP) / KUS		SET (UN) / KUS		SET (UN) / PÁR	
			bez DPH	s DPH	bez DPH	s DPH	bez DPH	s DPH	bez DPH	s DPH
300 mm	210 mm	NEM	35,00	42,00	41,50	49,80	48,50	58,20	75,00	90,00
400 mm	300 mm	NEM	41,00	49,20	47,50	57,00	54,50	65,40	87,00	104,40
500 mm	300 mm	NEM	45,50	54,60	52,00	62,40	59,00	70,80	96,00	115,20
600 mm	400 mm	NEM	50,00	60,00	56,50	67,80	63,50	76,20	105,00	126,00
800 mm	600 mm	NEM	54,00	64,80	60,50	72,60	67,50	81,00	113,00	135,60
1000 mm	700 mm	NEM	66,00	79,20	72,50	87,00	79,50	95,40	137,00	164,40
1200 mm	900 mm	NEM	66,50	79,80	73,00	87,60	80,00	96,00	138,00	165,60
1500 mm	1300 mm	NEM	89,00	106,80	95,50	114,60	102,50	123,00	183,00	219,60
*1600 mm	1300 mm	NEM	123,50	148,20	136,50	163,80	150,50	180,60	257,00	308,40
*1800 mm	1500 mm	NEM	138,00	165,60	151,00	181,20	165,00	198,00	286,00	343,20
*2000 mm	1800 mm	NEM	143,50	172,20	156,50	187,80	170,50	204,60	297,00	356,40

* madlo s 3 úchytmí

i Spojovací materiál je súčasťou balenia.

i Vyosené madlo



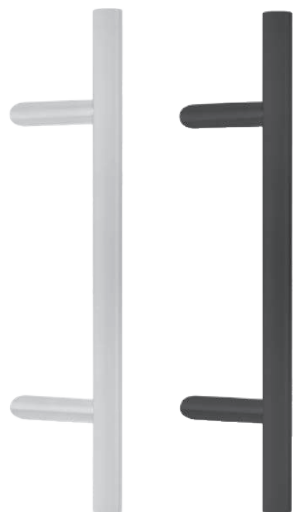

BIM BIELA
MATNÁ

CIM ČIERNÁ
MATNÁ

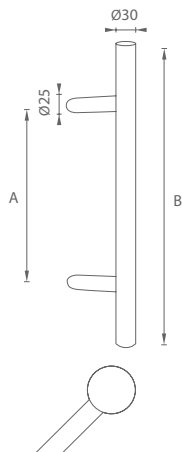

OVERTE
CENU

FT - K10/Ø30 - MADLO

dĺžka (B)	rozteč (A)	Cena v €	jedostranná montáž jedného madla DREVO		jedostranná montáž jedného madla DREVO, PVC, AL		obojsstranná montáž jedného madla DREVO, PVC, AL, SKLO		obojsstranná montáž dvoch madiel DREVO, PVC, AL, SKLO	
			SET (ST) / KUS	SET (SP) / KUS	SET (UN) / KUS	SET (UN) / PÁR				
			bez DPH	s DPH	bez DPH	s DPH	bez DPH	s DPH	bez DPH	s DPH
300 mm	210 mm	BIM, CIM	65,00	78,00	71,50	85,80	81,00	97,20	135,00	162,00
400 mm	300 mm	BIM, CIM	71,00	85,20	77,50	93,00	87,00	104,40	147,00	176,40
500 mm	300 mm	BIM, CIM	75,50	90,60	82,00	98,40	91,50	109,80	156,00	187,20
600 mm	400 mm	BIM, CIM	80,00	96,00	86,50	103,80	96,00	115,20	165,00	198,00
800 mm	600 mm	BIM, CIM	84,00	100,80	90,50	108,60	100,00	120,00	173,00	207,60
1000 mm	700 mm	BIM, CIM	114,00	136,80	120,50	144,60	130,00	156,00	233,00	279,60
1200 mm	900 mm	BIM, CIM	114,50	137,40	121,00	145,20	130,50	156,60	234,00	280,80
1500 mm	1300 mm	BIM, CIM	164,00	196,80	170,50	204,60	180,00	216,00	333,00	399,60
*1600 mm	1300 mm	BIM, CIM	198,50	238,20	211,50	253,80	230,50	276,60	407,00	488,40
*1800 mm	1500 mm	BIM, CIM	213,00	255,60	226,00	271,20	245,00	294,00	436,00	523,20
*2000 mm	1800 mm	BIM, CIM	218,50	262,20	231,50	277,80	250,50	300,60	447,00	536,40

* madlo s 3 úchytni

i Spojovací materiál je súčasťou balenia.

i Vyosené madlo

5
ROKOV ZÁRUKA

MATERIÁL: NEREZ

MATERIÁL: NEREZ



NEM NEREZ MATNÁ

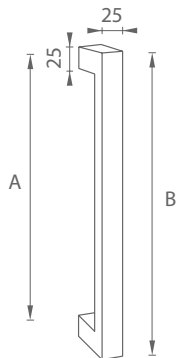

OVERTE
CENU

FT - K02K/25X25 - MADLO			jedostranná montáž jedného madla DREVO		jedostranná montáž jedného madla DREVO, PVC, AL		obojustranná montáž jedného madla DREVO, PVC, AL, SKLO		obojustranná montáž dvoch madiel DREVO, PVC, AL, SKLO	
			SET (ST) / KUS		SET (SP) / KUS		SET (UN) / KUS		SET (UN) / PÁR	
dĺžka (B)	rozteč (A)	Cena v €	bez DPH	s DPH	bez DPH	s DPH	bez DPH	s DPH	bez DPH	s DPH
225 mm	200 mm	NEM	26,00	31,20	32,50	39,00	39,50	47,40	57,00	68,40
325 mm	300 mm	NEM	29,00	34,80	35,50	42,60	42,50	51,00	63,00	75,60
625 mm	600 mm	NEM	44,00	52,80	50,50	60,60	57,50	69,00	93,00	111,60
925 mm	900 mm	NEM	60,50	72,60	67,00	80,40	74,00	88,80	126,00	151,20
1225 mm	1200 mm	NEM	69,00	82,80	75,50	90,60	82,50	99,00	143,00	171,60

5
ROKOV ZÁRUKA



i Spojovací materiál je súčasťou balenia.

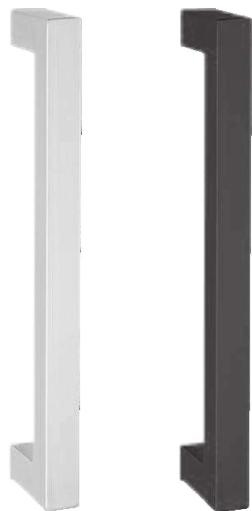

BIM BIELA
MATNÁ

CIM ČIERNA
MATNÁ

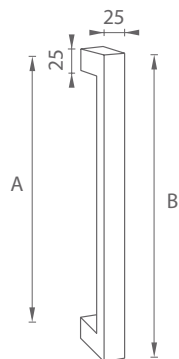

OVERTE
CENU

FT - K02K/25X25 - MADLO

dĺžka (B)	rozteč (A)	Cena v €	jedostranná montáž jedného madla DREVO		jedostranná montáž jedného madla DREVO, PVC, AL		obojsstranná montáž jedného madla DREVO, PVC, AL, SKLO		obojsstranná montáž dvoch madiel DREVO, PVC, AL, SKLO	
			SET (ST) / KUS	SET (SP) / KUS	SET (UN) / KUS	SET (UN) / PÁR				
			bez DPH	s DPH	bez DPH	s DPH	bez DPH	s DPH	bez DPH	s DPH
225 mm	200 mm	BIM, CIM	56,00	67,20	62,50	75,00	72,00	86,40	117,00	140,40
325 mm	300 mm	BIM, CIM	59,00	70,80	65,50	78,60	75,00	90,00	123,00	147,60
625 mm	600 mm	BIM, CIM	74,00	88,80	80,50	96,60	90,00	108,00	153,00	183,60
925 mm	900 mm	BIM, CIM	90,50	108,60	97,00	116,40	106,50	127,80	186,00	223,20
1225 mm	1200 mm	BIM, CIM	117,00	140,40	123,50	148,20	133,00	159,60	239,00	286,80

5
ROKOV ZÁRUKA

MATERIÁL: NEREZ

i Spojovací materiál je súčasťou balenia.

MATERIÁL: NEREZ

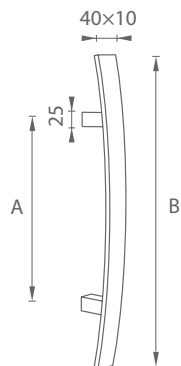

NEM NEREZ MATNÁ

OVERTE
CENU

			jedostranná montáž jedného madla DREVO		jedostranná montáž jedného madla DREVO, PVC, AL		obojustranná montáž jedného madla DREVO, PVC, AL, SKLO		obojustranná montáž dvoch madiel DREVO, PVC, AL, SKLO	
FT - K41C/40X10 - MADLO			SET (ST) / KUS		SET (SP) / KUS		SET (UN) / KUS		SET (UN) / PÁR	
dĺžka (B)	rozteč (A)	Cena v €	bez DPH	s DPH	bez DPH	s DPH	bez DPH	s DPH	bez DPH	s DPH
500 mm	300 mm	NEM	44,00	52,80	50,50	60,60	57,50	69,00	93,00	111,60
600 mm	400 mm	NEM	50,00	60,00	56,50	67,80	63,50	76,20	105,00	126,00
800 mm	600 mm	NEM	63,00	75,60	69,50	83,40	76,50	91,80	131,00	157,20

5



i Spojovací materiál je súčasťou balenia.



BIM BIELA
MATNÁ

CIM ČIERNA
MATNÁ

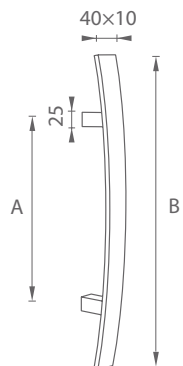

OVERTE
CENU

FT - K41C/40X10 - MADLO

dĺžka (B)	rozteč (A)	Cena v €	jedostranná montáž jedného madla DREVO		jedostranná montáž jedného madla DREVO, PVC, AL		obojostranná montáž jedného madla DREVO, PVC, AL, SKLO		obojostranná montáž dvoch madiel DREVO, PVC, AL, SKLO	
			SET (ST) / KUS	SET (SP) / KUS	SET (UN) / KUS	SET (UN) / PÁR				
			bez DPH	s DPH	bez DPH	s DPH	bez DPH	s DPH	bez DPH	s DPH
500 mm	300 mm	BIM, CIM	74,00	88,80	80,50	96,60	90,00	108,00	153,00	183,60
600 mm	400 mm	BIM, CIM	80,00	96,00	86,50	103,80	96,00	115,20	165,00	198,00
800 mm	600 mm	BIM, CIM	93,00	111,60	99,50	119,40	109,00	130,80	191,00	229,20

5
ROKOV ZÁRUKA

MATERIÁL: NEREZ

i Spojovací materiál je súčasťou balenia.

DOPLNKY

MUŠLE NA POSUVNÉ DVERE
A POSUVNÉ SYSTÉMY



VYSVETLIVKY MUŠLE



3 alebo 5 rokov záruka



súčasťou balenia sú samorezné skrutky v príslušnom počte ku kovaniu



súčasťou balenia je sada skrutiek na preskrutkovanie cez dvere



montáž krytky, mušle lepením

VYSVETLIVKY POSUVNÉ SYSTÉMY



5 alebo 10 rokov záruka



posuvné dvere



spomaľovač dovierania posuvných dverí



zalamovacie dvere



patentovaný systém



hrúbka dverí v mm



guličkové ložisko



váha dverí v kg



nylonové ložisko



výšková nastaviteľnosť



zosilnený profil



dĺžka profilu



skrytý posuvný systém



kotvenie na stenu



tichý chod



kotvenie do stropu a zárubne



synchronizované otváranie a zatváranie dverí



kotvenie na stenu a do stropu



CHL CHRÓM
LESKLÝ (CP)

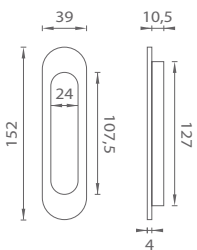

MATERIÁL: ZAMAK



BIM BIELA MATNÁ



**ZLL
PVD** ZLATÁ LESKLÁ
(GOLD PVD)



BRM BRONZ
MATNÝ



CHM CHRÓM
MATNÝ (MSC)



ZLM ZLATÁ MATNÁ
(GOLD SATIN)



BRA BRONZ
ANTIK (DAB)



NIM NIKEL
MATNÝ (MSN)



GRM GRAFIT
MATNÝ (MSB)



CIM ČIERNA MATNÁ



MP - MUŠĽA OVÁLNA 040

	Cena za kus v €	bez DPH	s DPH
mušľa oválna		11,00	13,20



OVERTE
CENU



CHL CHRÓM
LESKLÝ (CP)



BIM BIELA MATNÁ



CHM CHRÓM
MATNÝ (MSC)



NIM NIKEL
MATNÝ (MSN)



GRM GRAFIT
MATNÝ (MSB)



CIM ČIERNA MATNÁ

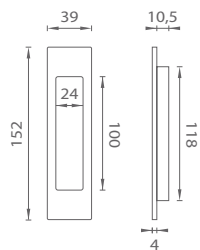

MP - MUŠĽA HRANATÁ 039

	Cena za kus v €	bez DPH	s DPH
mušľa hranatá		12,00	14,40



OVERTE
CENU



CHL CHRÓM LESKLÝ (F04)

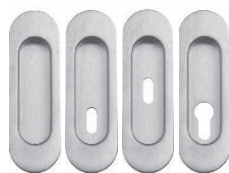

CHM CHRÓM MATNÝ (F05)

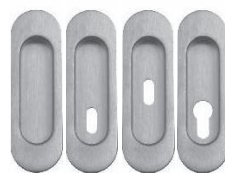

NEM NEREZ MATNÁ (F60)



ZLL ZLATÁ LESKLÁ (F01)



ZLM. LL ZLATÁ MATNÁ (F02)



NIM. LL NIKEL MATNÝ (F20)



BRM BRONZ MATNÝ (F43)



ANM ANTRACIT MATNÝ (F15)



CIM ČIERNÁ MATNÁ (FN0)

MATERIÁL: MOSADZ

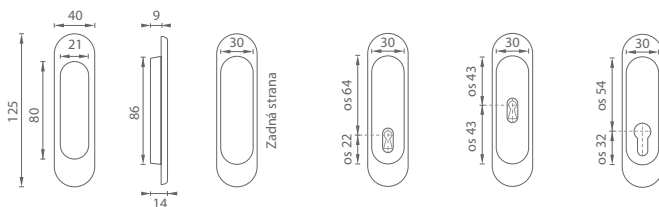

FT - MUŠĽA OVÁLNÁ 3665

	Cena za kus v €	bez DPH	s DPH
mušľa oválna bez otvoru		10,00	12,00
mušľa oválna s BB/D otvorom		10,00	12,00
mušľa oválna s BB/S otvorom		10,00	12,00
mušľa oválna s PZ otvorom		10,00	12,00



OVERTE
CENU

DOPLNKY

WC



CHL CHRÓM LESKLÝ (F04)



CHM CHRÓM MATNÝ (F05)



NEM NEREZ MATNÁ (F60)



ZLL ZLATÁ LESKLÁ (F01)



ZLM. LL ZLATÁ MATNÁ (F02)



NIM. LL NIKEL MATNÝ (F20)



BRM BRONZ MATNÝ (F43)



ANM ANTRACIT MATNÝ (F15)



CIM ČIERNÁ MATNÁ (FN0)

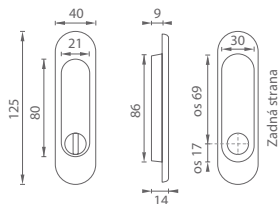

FT - MUŠĽA OVÁLNA 3665 S UZAMYKANÍM

	Cena za pár v €	
	bez DPH	s DPH
mušľa oválna s uzamykaním	30,00	36,00



OVERTE
CENU

MATERIÁL: MŌSADZ

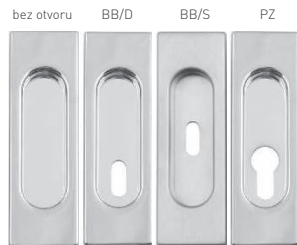

CHL CHRÓM LESKLÝ (F04)



BIM BIELA MATNÁ (FBO)



CHM CHRÓM MATNÝ (F05)



NEM NEREZ MATNÁ (F60)



NIM NIKEL MATNÝ (F54)

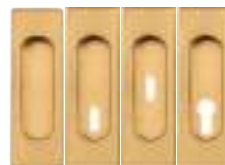

ZLM.LL ZLATÁ MATNÁ (F020)



MEM.S MEĎ MATNÁ SVETLÁ (F07)



MEM.T MEĎ MATNÁ TMAVÁ (F13)



BRM BRONZ MATNÝ (F43)



ANM ANTRACIT MATNÝ (F15)



CIM ČIERNA MATNÁ (FNO)

MATERIÁL: MOSADZ

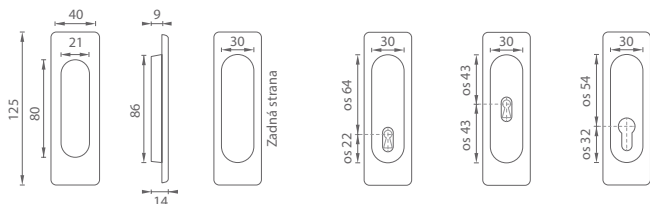

FT - MUŠĽA HRANATÁ 3663



	Cena za kus v €	bez DPH	s DPH
mušľa hranatá bez otvoru		12,00	14,40
mušľa hranatá s BB/D otvorom		12,00	14,40
mušľa hranatá s BB/S otvorom		12,00	14,40
mušľa hranatá s PZ otvorom		12,00	14,40



OVERTE
CENU

DOPLNKY

s uzamykaním



CHL CHRÓM LESKLÝ (F04)



BIM BIELA MATNÁ (FBO)



CHM CHRÓM MATNÝ (F05)

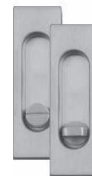

NEM NEREZ MATNÁ (F60)



NIM NIKEL MATNÝ (F54)



ZLM.
LL ZLATÁ MATNÁ (F020)



MEM.
S MEĎ MATNÁ SVETLÁ (F07)



MEM.
T MEĎ MATNÁ TMAVÁ (F13)



BRM BRONZ MATNÝ (F43)

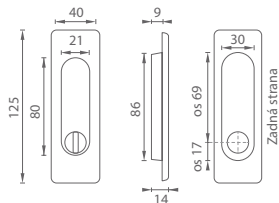

ANM ANTRACIT MATNÝ (F15)





CIM ČIERNA MATNÁ (FNO)

MATERIÁL: MOSADZ



FT - MUŠĽA HRANATÁ 3663 S UZAMYKANÍM

	Cena za pár v €	bez DPH	s DPH
mušľa hranatá s uzamykaním  		32,00	38,40



OVERTE
CENU

IN.16.412



NEM NEREZ MATNÁ

CIM.PVD ČIERNÁ MATNÁ (TB)

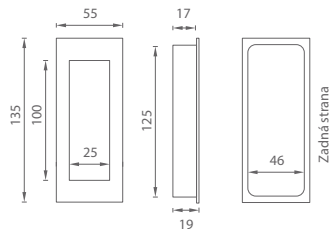

IN.16.416



NEM NEREZ MATNÁ

CIM.PVD ČIERNÁ MATNÁ (TB)

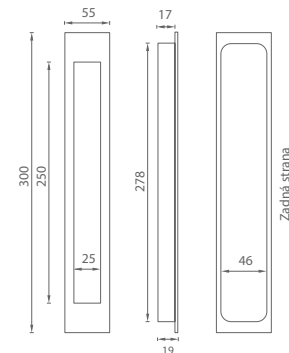

MATERIÁL: NEREZ



JNF - MUŠĽA HRANATÁ

	Cena za kus v €	bez DPH	s DPH
mušľa IN.16.412 - NEM		17,20	20,64
mušľa IN.16.412 - CIM.PVD		34,60	41,52
mušľa IN.16.416 - NEM		33,60	40,32
mušľa IN.16.416 - CIM.PVD		62,00	74,40



OVERTE
CENU



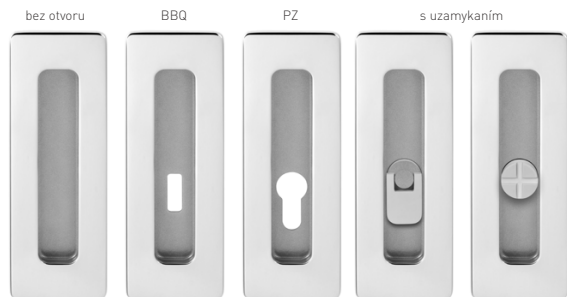

CHL CHRÓM
LESKLÝ (03)

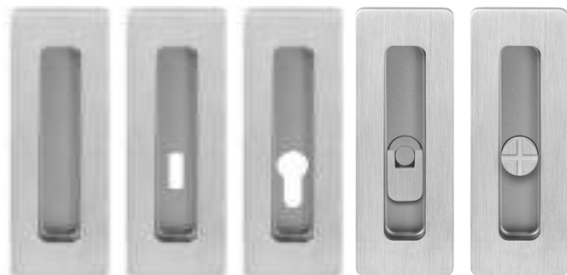

CHM CHRÓM
MATNÝ (18)

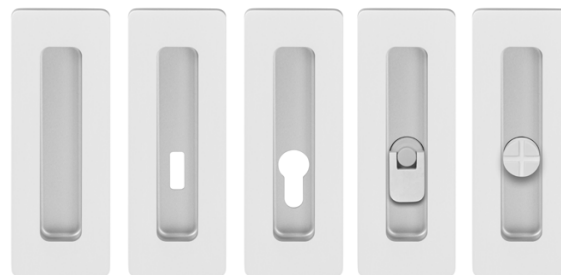

BIM BIELA
MATNÁ (152)



NIM NIKEL
MATNÝ (142)

MATERIÁL: MOŠADZ



TI - MUŠĽA HRANATÁ 4181 5S

	Cena v €	bez DPH	s DPH
mušľa 4181 bez otvoru - kus		30,00	36,00
mušľa 4181 BBQ - kus		30,00	36,00
mušľa 4181 PZ - kus		30,00	36,00
mušľa 4181 s uzamykaním - pár		90,00	108,00



OVERTE
CENU

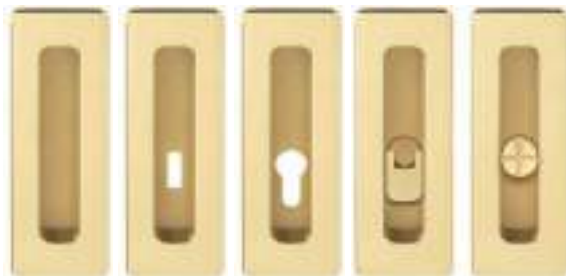

ZLL ZLATÁ
LESKLÁ (01)

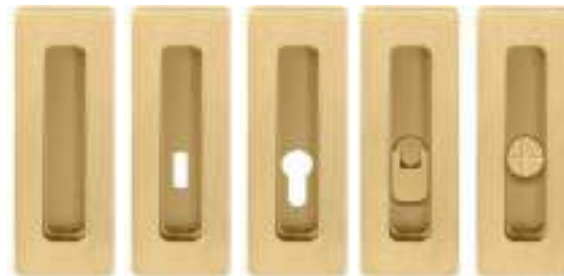

ZLM.
LL ZLATÁ
MATNÁ (158)



GRM GRAFIT
MATNÝ
(141)

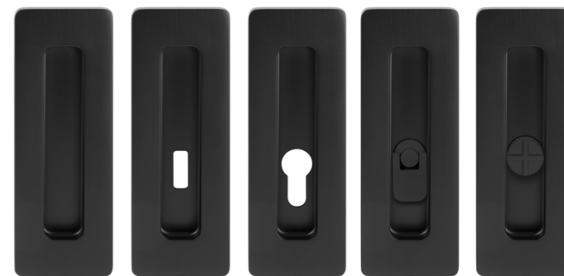

CIM ČIERNA
MATNÁ (153)

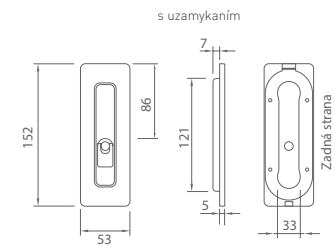
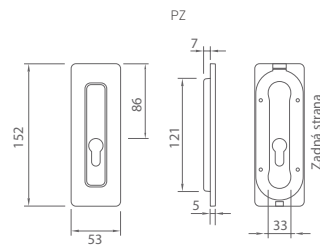
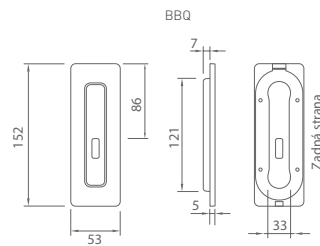
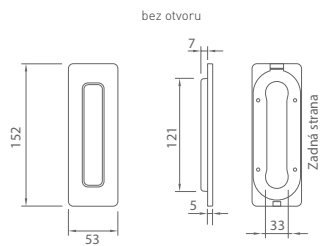

MATERIÁL: MŌSADZ



CHL CHRÓM LESKLÝ (C011)



CHM CHRÓM MATNÝ (E215)



NIM NIKEL MATNÝ (E216)





GRM GRAFIT MATNÝ (E387)



CIM ČIERNÁ MATNÁ (E228)



PR - MUŠĽA HRANATÁ

	Cena za pár v €	CHM, NIM, GRM, CIM		CHL	
		bez DPH	s DPH	bez DPH	s DPH
mušľa bez otvoru 1098Z		58,00	69,60	68,00	81,60
mušľa s BB otvorom 1099Z BB 		58,00	69,60	72,00	86,40
mušľa s PZ otvorom 1100Z PZ 		58,00	69,60	72,00	86,40

OVERTE CENU

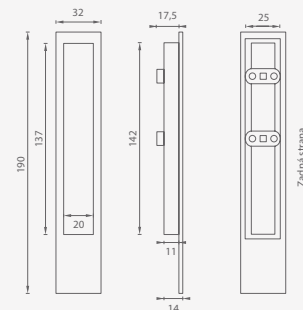

s uzamykaním

WC



CHL CHRÓM LESKLÝ
(C011)



CHM CHRÓM MATNÝ
(E215)



NIM NIKEL MATNÝ
(E216)





GRM GRAFIT MATNÝ
(E387)

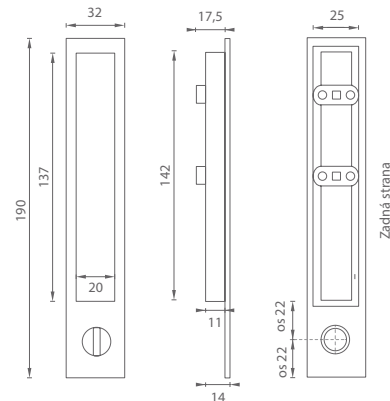

CIM ČIERNÁ MATNÁ
(E228)



PR - MUŠĽA HARANTÁ 1096Z

	Cena za pár v €	CHM, NIM, GRM, CIM		CHL	
		bez DPH	s DPH	bez DPH	s DPH
mušľa s uzamykaním 1096Z  		74,00	88,80	89,00	106,80



OVERTE
CENU

bez otvoru



CHL

CHRÓM LESKLÝ
(C011)

CHM

CHRÓM MATNÝ
(E215)

NIM

NIKEL MATNÝ
(E216)

GRM

GRAFIT MATNÝ
(E387)

CIM

ČIERNA MATNÁ
(E228)

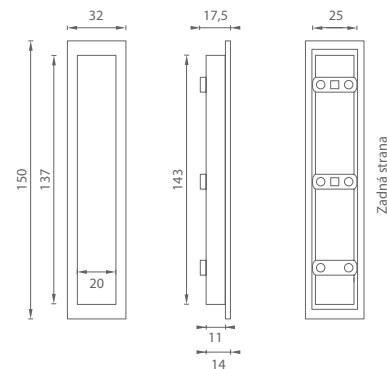

MATERIÁL: ZAMAK



PR - MUŠĽA HRANATÁ 1097Z

	CHM, NIM, GRM, CIM		CHL	
	bez DPH	s DPH	bez DPH	s DPH
mušľa bez otvoru 1097Z	53,00	63,60	67,00	80,40



OVERTE
CENU



CHL CHRÓM LESKLÝ (C011)
CHM CHRÓM MATNÝ (E215)
NIM NIKEL MATNÝ (E216)
GRM GRAFIT MATNÝ (E387)
CIM ČIERNA MATNÁ (E228)

! Pri objednávke je potrebné uviesť hrúbku skla pre správnu podložku v rozmere 6, 8, 10 a 12 mm.



podložka 6 mm



podložka 8 mm



podložka 10 mm



podložka 12 mm



PR - MUŠĽA HRANATÁ 1158Z NA POSUVNÉ SKLENÉ DVERE

	CHM, NIM, GRM, CIM		CHL	
	bez DPH	s DPH	bez DPH	s DPH
mušľa bez otvoru	71,00	85,20	86,00	103,20



OVERTE
CENU

MATERIÁL: ZAMAK

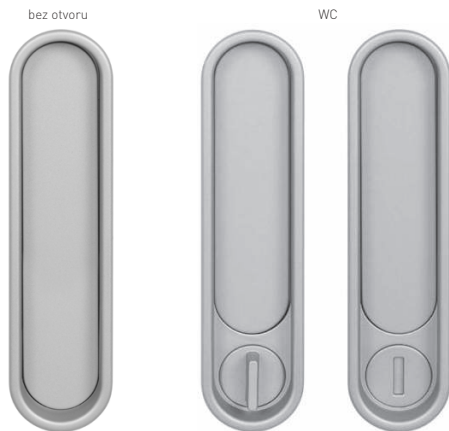

CHM CHRÓM MATNÝ (E215)



NIM NIKEL MATNÝ (E216)



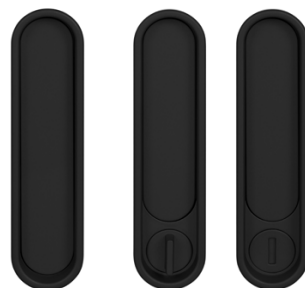

GRM GRAFIT MATNÝ (E387)

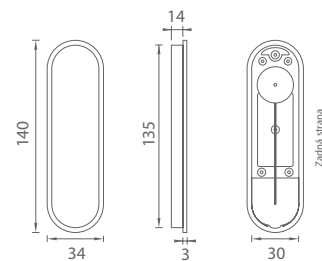

CIM ČIERNÁ MATNÁ (E228)



PR - MUŠĽA OVÁLNÁ

	Cena za pár v €	bez DPH	s DPH
mušľa bez otvoru MN2648Z		61,00	73,20
mušľa s uzamykaním MN2647Z  		77,50	93,00



OVERTE
CENU





CHM CHRÓM MATNÝ
(E215)



NIM NIKEL MATNÝ
(E216)



GRM GRAFIT MATNÝ
(E387)



CIM ČIERNA MATNÁ
(E228)

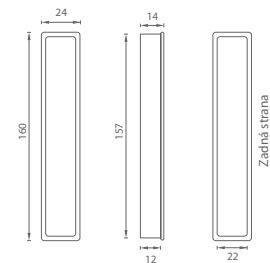

MATERIÁL: ZAMAK



PR - VÝKLOPNÁ ÚCHYTKA 1032Z

	CHM, NIM, CIM		GRM	
	bez DPH	s DPH	bez DPH	s DPH
úchytka do čela dverného krídla 1032Z	26,00	31,20	29,00	34,80



OVERTE
CENU

PUSH R

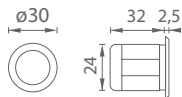
CHM CHRÓM MATNÝ
(E215)

PUSH HR

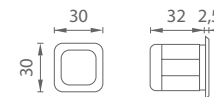
CHM CHRÓM MATNÝ
(E215)

NIM NIKEL MATNÝ
(E216)

GRM GRAFIT MATNÝ
(E387)

CIM ČIERNA MATNÁ
(E228)

NIM NIKEL MATNÝ
(E216)

GRM GRAFIT MATNÝ
(E387)

CIM ČIERNA MATNÁ
(E228)
**PR - ÚCHYTKA PUSH**

	CHM, NIM, CIM		GRM	
	bez DPH	s DPH	bez DPH	s DPH
úchytka PUSH R	30,50	36,60	34,00	40,80
úchytka PUSH HR	30,50	36,60	34,00	40,80

Cena za kus v €

**OVERTE
CENU**



CHL CHRÓM
LESKLÝ (F04)



CHM CHRÓM
MATNÝ (F05)



NIM, LL NIKEL
MATNÝ (F20)



ZLM, LL ZLATÁ
MATNÁ (F02)



BRM BRONZ
MATNÝ (F43)



ZLL ZLATÁ
LESKLÁ (F01)



CIM ČIERNA
MATNÁ (FNO)



NEM NEREZ
MATNÁ



CIM ČIERNA
MATNÁ

i čierna nerez

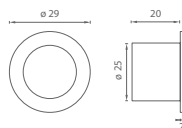

MADIELKO DO ČELA OVÁLNE

	Cena za kus v €	
	bez DPH	s DPH
FT - madielko oválne MT	4,50	5,40
ATZ - madielko oválne 3918 - NEM	7,50	9,00
ATZ - madielko oválne 3918 - CIM	9,50	11,40



OVERTE
CENU

DOPLNKY

MQ



CHL CHRÓM
LESKLÝ (F04)

MQ



CHM CHRÓM
MATNÝ (F05)

MQ



NIM NIKEL
MATNÝ (FNP)

MQ



BRM BRONZ
MATNÝ (F43)

MQ

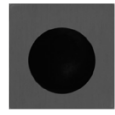

CIM ČIERNA
MATNÁ (FNO)

3919



NEM NEREZ
MATNÁ

3919



CIM ČIERNA
MATNÁ

i čierna nerez

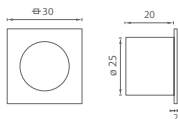

MADIELKO DO ČELA HRANATÉ

	Cena za kus v €	bez DPH	s DPH
FT - madielko hranaté MQ		4,50	5,40
ATZ - madielko hranaté 3919 NEM		7,50	9,00
ATZ - madielko hranaté 3919 CIM		9,50	11,40



OVERTE
CENU

MATERIÁL: ZAMAK

MATERIÁL: ZAMAK



CHL CHRÓM LESKLÝ
(OCL)



ZLL ZLATÁ LESKLÁ
(OLV)



CHM CHRÓM MATNÝ
(OCS)



NIM.LL NIKEL MATNÝ
(ONS)



BRM BRONZ MATNÝ
(OGM)



CIM ČIERNA MATNÁ
(BLK)

Set na posuvné dvere SAB - HookyZERO sa inštaluje **BEZ POUŽITIA NÁRADIA A SKRUTIEK**. Automaticky sa prispôsobí hrúbke dverí od 38 do 48 mm.

VEĽKÁ TOLERANCIA MEDZI ZÁPADKOU A OTVOROM V PROTIPLECHU (+/- 7 mm) v porovnaní s bežnými zámkami - vyváža nesprávne nastavenie dverí.

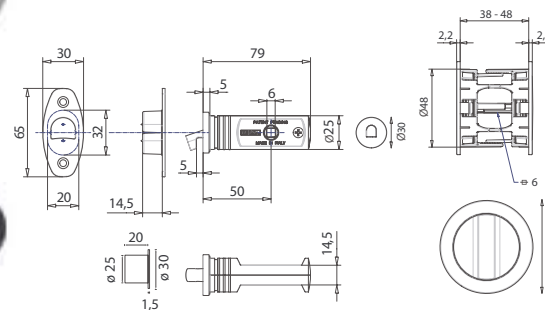

SAB - HOOKY ZERO - R S UZAMYKANÍM

	Cena za set v €	bez DPH	s DPH
set na posuvné dvere		60,00	72,00

OVERTE
CENU





CHL CHRÓM LESKLÝ
(OCL)



ZLL ZLATÁ LESKLÁ
(OLV)



CHM CHRÓM MATNÝ
(OCS)



NIM.
LL NIKEL MATNÝ
(ONS)



BRM BRONZ MATNÝ
(OGM)



CIM ČIERNA MATNÁ
(BLK)

Set na posuvné dvere SAB - HookyZERO sa inštaluje **BEZ POUŽITIA NÁRADIA A SKRUTIEK**. Automaticky sa prispôsobí hrúbke dverí od 38 do 48 mm.

VEĽKÁ TOLERANCIA MEDZI ZÁPADKOU A OTVOROM V PROTIPLECHU (+/- 7 mm) v porovnaní s bežnými zámkami - vyváža nesprávne nastavenie dverí.

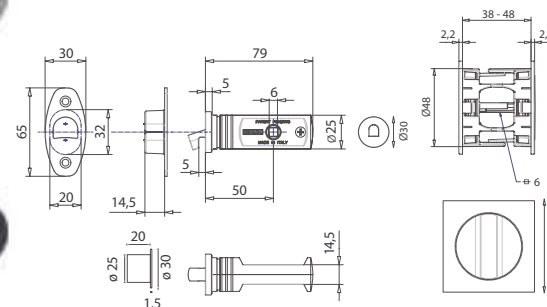

MATERIÁL: ZAMAK



SAB - HOOKY ZERO - HR S UZAMYKANÍM

	Cena za set v €	bez DPH	s DPH
set na posuvné dvere		75,00	90,00

OVERTE
CENU



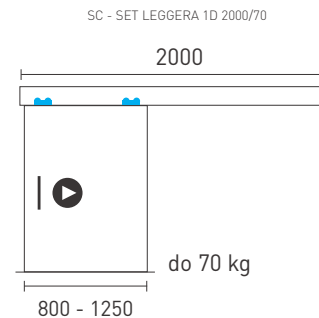
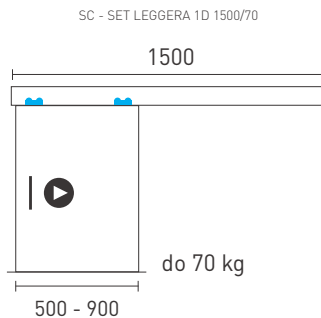
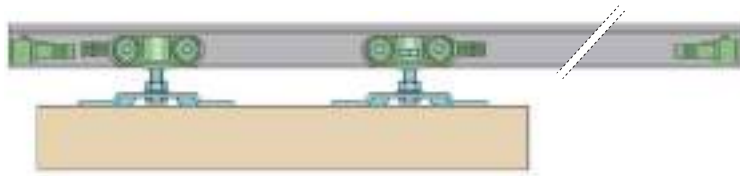

SÉRIA LEGGERA
Základné riešenie pre jedнокrídlové posuvné dvere do 70 kg

Komponenty, typy montáží
a doplnky - str. 349



Legenda

-  - posuvný vozík
-   - smer otvárania



SC - SET LEGGERA 1D 1500/70

	Cena za set v €	bez DPH	s DPH
Balenie posuvného systému 1 set		46,00	55,20
Profil hliník 100 LEGGERA 1,5 m			

SC - SET LEGGERA 1D 2000/70

	Cena za set v €	bez DPH	s DPH
Balenie posuvného systému 1 set		55,00	66,00
Profil hliník 100 LEGGERA 2 m			

OVERTE
CENU

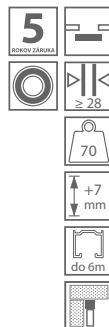
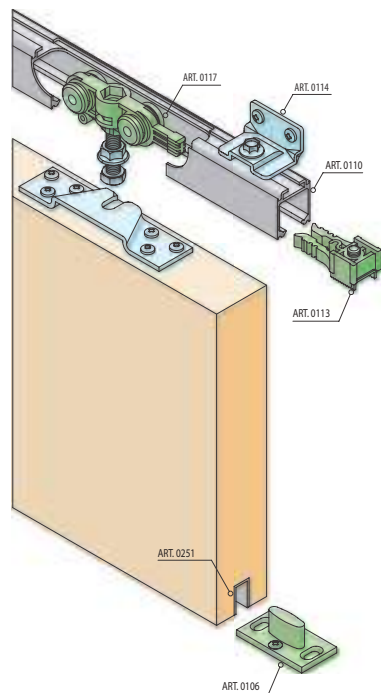

Balenie posuvného systému - 0117P

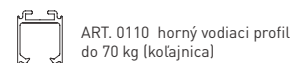
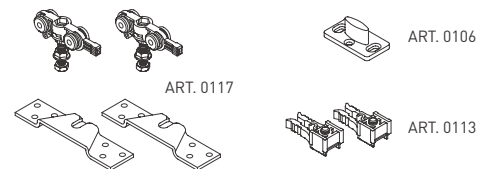

Doplňky za prílatok

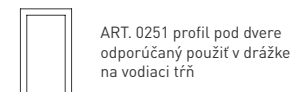

OVERTE
CENU

SC - KOMPONENTY LEGGERA DO 70 KG

	ks/set/m	Cena v €	
		bez DPH	s DPH
Profil horný vodiaci pre LEGGERA , ART.0110	1 m	17,00	20,40
Balenie posuvného systému LEGGERA, ART.0117P	1 set	21,00	25,20
Úchytka pre montáž koľajnice LEGGERA na stenu, ART. 0114	1 ks	1,00	1,20
Kryt na uchytenie garniže, ART. 0115	1 ks	1,00	1,20
Profil hliníkový pod dvere, ART. 0251	1 m	5,00	6,00

SÉRIA 100 SILENT 1D
Riešenie pre jednokrídlové posuvné dvere bez spomaľovačov do 80 kg

Komponenty, typy montáží
a doplnky - str. 351

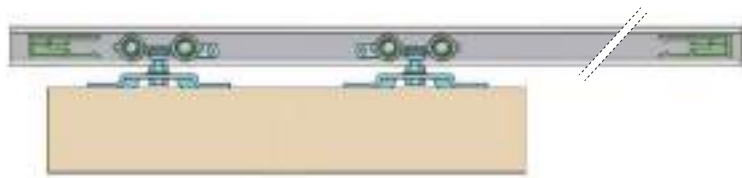

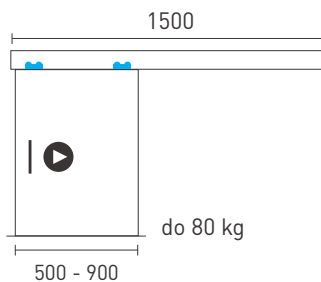

SC - SET 100 SILENT 1D 1500/80

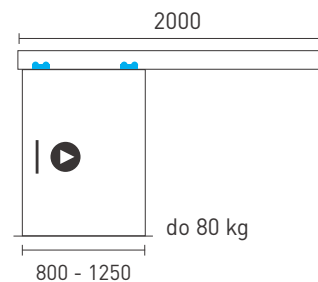

SC - SET 100 SILENT 1D 2000/80



Legenda

-  - posuvný vozík
-   - smer otvárania



SC - SET 100 SILENT 1D 1500/80

	Cena za set v €	
	bez DPH	s DPH
Balenie posuvného systému 1 set		
Profil hliník 100 SILENT 1,5 m	68,00	81,60

SC - SET 100 SILENT 1D 2000/80

	Cena za set v €	
	bez DPH	s DPH
Balenie posuvného systému 1 set		
Profil hliník 100 SILENT 2 m	78,00	93,60

OVERTE
CENU

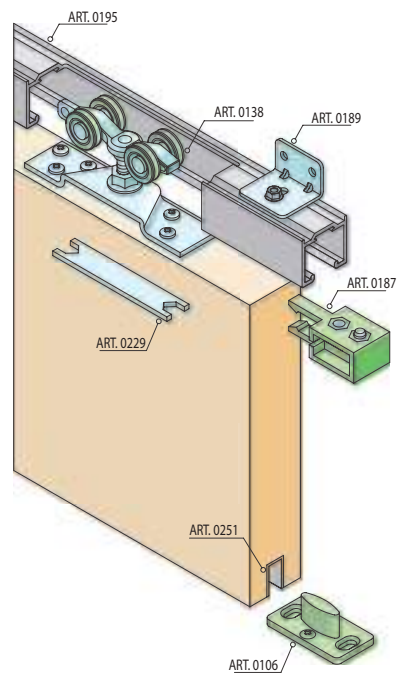

Balenie posuvného systému - 0138P

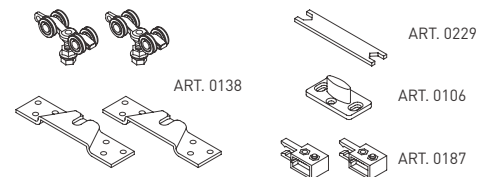

ART. 0195 horný vodiaci profil
do 80 kg (koľajnica)

Doplňky za príplatok



ART. 0189 úchytka na montáž
koľajnice na stenu



ART. 0251 profil pod dvere
odporúčanej použiť v drážke
na vodiaci trň



OVERTE
CENU

SC - KOMPONENTY 100 SILENT DO 80 KG

	ks/set/m	Cena v €	
		bez DPH	s DPH
Profil horný vodiaci pre 100 SILENT do 80kg, ART.0195	1 m	20,00	24,00
Balenie posuvného systému 100 SILENT SOFT, ART.0138P	1 set	38,00	45,60
Úchytka pre montáž koľajnice 100 SILENT na stenu, ART. 0189	1 ks	2,00	2,40
Profil hliníkový pod dvere, ART. 0251	1 m	5,00	6,00

SÉRIA 100 SILENT 2D
Riešenie pre dvojkrídlové posuvné dvere bez spomaľovačov do 80 kg

Komponenty, typy montáží
a doplnky - str. 353

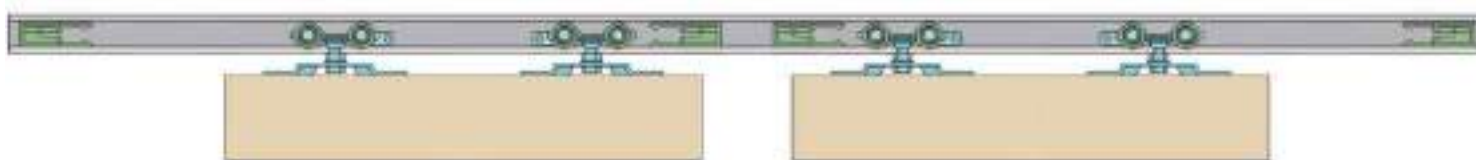

SC - SET 100 SILENT 2D 3000/80

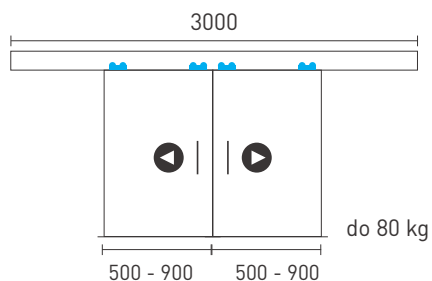

SC - SET 100 SILENT 2D 4000/80

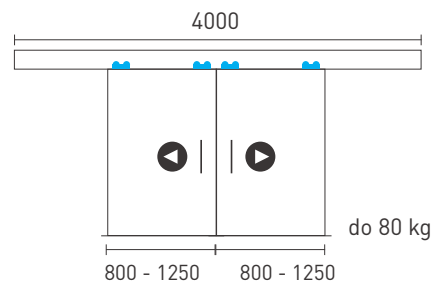

Legenda

 - posuvný vozík

  - smer otvárania



SC - SET 100 SILENT 2D 3000/80

	Cena za set v €	
	bez DPH	s DPH
Balenie posuvného systému 2 sety		
Profil hliník 100 SILENT 3 m	136,00	163,20

SC - SET 100 SILENT 2D 4000/80

	Cena za set v €	
	bez DPH	s DPH
Balenie posuvného systému 2 sety		
Profil hliník 100 SILENT 4 m	156,00	187,20

OVERTE
CENU

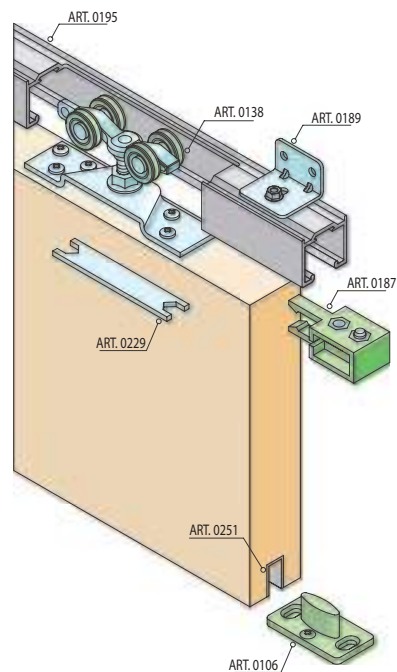

Balenie posuvného systému - 0138P

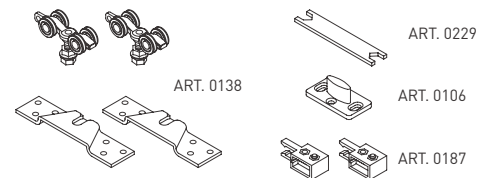

ART. 0195 horný vodiaci profil
do 80 kg (koľajnica)

Doplňky za príplatok



ART. 0189 úchytka na montáž
koľajnice na stenu



ART. 0251 profil pod dvere
odporúčanej použiť v drážke
na vodiaci trň

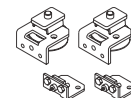

ART. 1911 - 1913
Balenie doplnkového systému SINCRO.
Voliteľný doplnok pre synchronované
otváranie a zatváranie dvojkrídlových dverí.



OVERTE
CENU

SC - KOMPONENTY 100 SILENT DO 80 KG

	ks/set/m	Cena v €	
		bez DPH	s DPH
Profil horný vodiaci pre 100 SILENT do 80kg, ART.0195	1 m	20,00	24,00
Balenie posuvného systému 100 SILENT SOFT, ART.0138P	1 set	38,00	45,60
Úchytka pre montáž koľajnice 100 SILENT na stenu, ART. 0189	1 ks	2,00	2,40
Balenie doplnkového systému SINCRO ART. 1911-1913	1 set	47,00	56,40
Profil hliníkový pod dvere, ART. 0251	1 m	5,00	6,00

SÉRIA 100 SILENT 1D
Riešenie pre jednokrídlové posuvné dvere bez spomaľovačov do 120 kg

Komponenty, typy montáží
a doplnky - str. 355

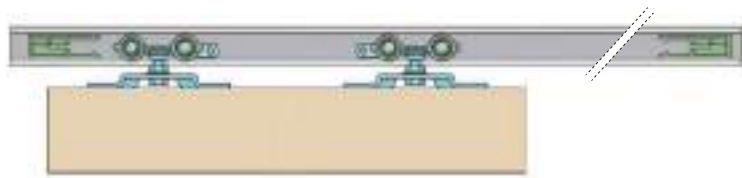

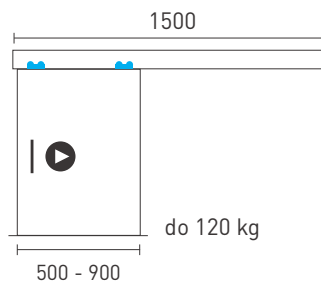

SC - SET 100 SILENT 1D 1500/120

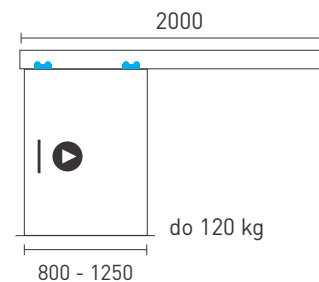

SC - SET 100 SILENT 1D 2000/120



Legenda

-  - posuvný vozík
-   - smer otvárania



SC - SET 100 SILENT 1D 1500/120

	Cena za set v €	
	bez DPH	s DPH
Balenie posuvného systému 1 set		
Profil hliník 100 SILENT do 120 kg 1,5 m	75,50	90,60

SC - SET 100 SILENT 1D 2000/120

	Cena za set v €	
	bez DPH	s DPH
Balenie posuvného systému 1 set		
Profil hliník 100 SILENT do 120 kg 2 m	88,00	105,60

OVERTE
CENU

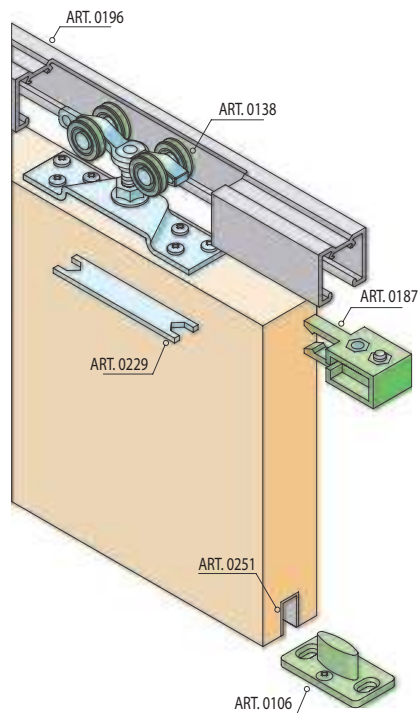

Balenie posuvného systému - 0138P

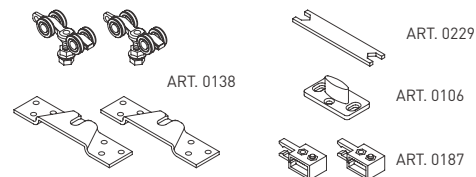

ART. 0196 horný vodiaci profil
do 120 kg (koľajnica)

Doplnky za príplatok



ART. 0251 profil pod dvere
odporúčany použiť v drážke na vodiaci trň



SC - KOMPONENTY 100 SILENT DO 120 KG

	ks/set/m	Cena v €	
		bez DPH	s DPH
Profil horný vodiaci pre 100 SILENT do 120kg, ART.0196	1 m	25,00	30,00
Balenie posuvného systému 100 SILENT SOFT, ART.0138P	1 set	38,00	45,60
Profil hliníkový pod dvere, ART. 0251	1 m	5,00	6,00

OVERTE
CENU

SÉRIA 100 SILENT 2D
Riešenie pre dvojkrídlové posuvné dvere bez spomaľovačov do 120 kg

Komponenty, typy montáží
a doplnky - str. 357

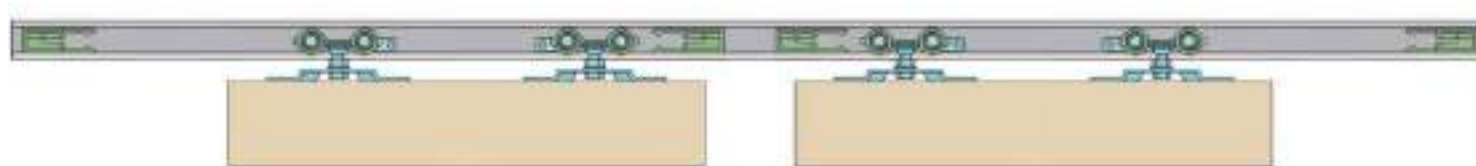

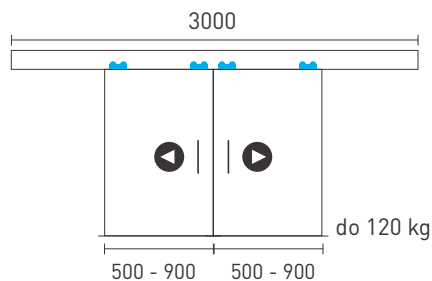

SC - SET 100 SILENT 2D 3000/120

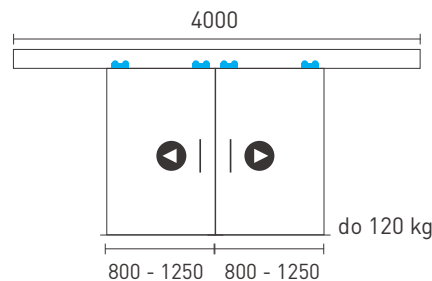

SC - SET 100 SILENT 2D 4000/120



Legenda

-  - posuvný vozík
-   - smer otvárania



SC - SET 100 SILENT 2D 3000/120

	Cena za set v €	
	bez DPH	s DPH
Balenie posuvného systému 2 sety		
Profil hliník 100 SILENT do 120 kg 3 m	151,00	181,20

SC - SET 100 SILENT 2D 4000/120

	Cena za set v €	
	bez DPH	s DPH
Balenie posuvného systému 2 sety		
Profil hliník 100 SILENT do 120 kg 4 m	176,00	211,20

OVERTE
CENU

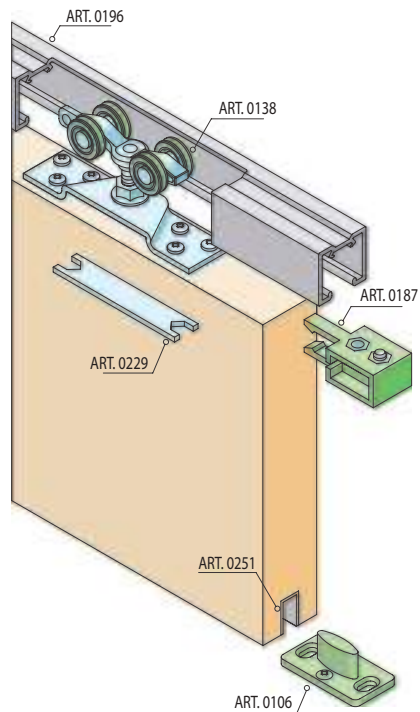

Balenie posuvného systému - 0138P

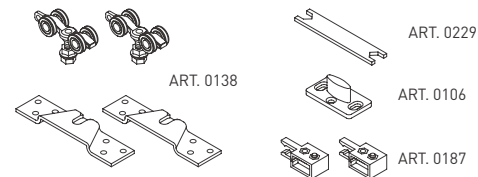

ART. 0196 horný vodiaci profil
do 120 kg (koľajnica)

Doplňky za príplatok



ART. 0251 profil pod dvere
odporúčaný použiť v drážke na vodiaci trň

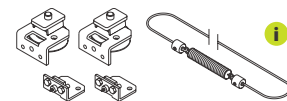

i ART. 1911 - 1913
Balenie doplnkového systému SINCRO.
Voľiteľný doplnok pre synchronizované
otváranie a zatváranie dvojkrídlových dverí.



OVERTE
CENU

SC - KOMPONENTY 100 SILENT DO 120 KG

	ks/set/m	Cena v €	
		bez DPH	s DPH
Profil horný vodiaci pre 100 SILENT do 120kg, ART.0196	1 m	25,00	30,00
Balenie posuvného systému 100 SILENT SOFT, ART.0138P	1 set	38,00	45,60
Balenie doplnkového systému SINCRO ART. 1911-1913	1 set	47,00	56,40
Profil hliníkový pod dvere, ART. 0251	1 m	5,00	6,00

SÉRIA 100 SILENT

Riešenie pre jednokrídlové posuvné dvere do 40 kg s obojstranným spomaľovačom

Komponenty, typy montáží
a doplnky - str. 359



SC - SET 100 SILENT S 1D 1500/40 SP

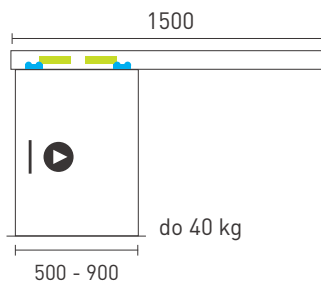

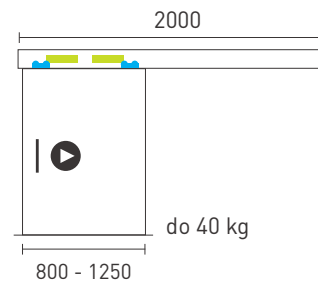

SC - SET 100 SILENT S 1D 2000/40 SP



Legenda

 - posuvný vozík

 - spomaľovač

  - smer otvárania



SC - SET 100 SILENT S 1D 1500/40 SP

	Cena za set v €	bez DPH	s DPH
Balenie posuvného systému 1 set			
Profil hliník 100 SILENT 1,5 m		106,00	127,20
Spomaľovač 2ks 100 SILENT do 40 kg			

SC - SET 100 SILENT S 1D 2000/40 SP

	Cena za set v €	bez DPH	s DPH
Balenie posuvného systému 1 set			
Profil hliník 100 SILENT 2 m		116,00	139,20
Spomaľovač 2ks 100 SILENT do 40 kg			

OVERTE
CENU

i Pre dverné krídlo menšie ako 720 mm je možné použiť iba 1 spomaľovač.

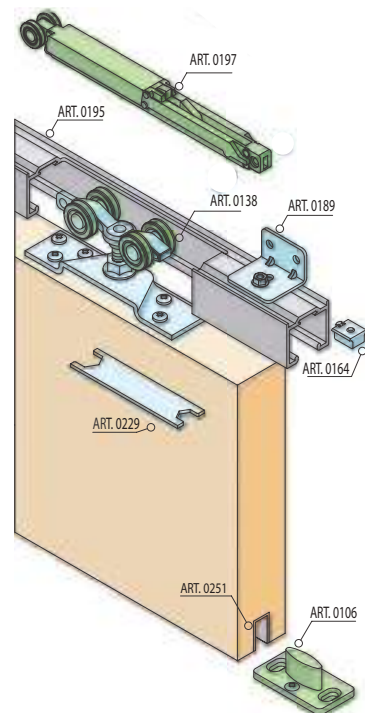

Balenie posuvného systému - 0138P

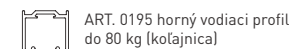
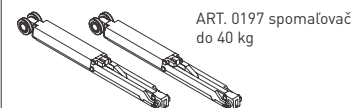
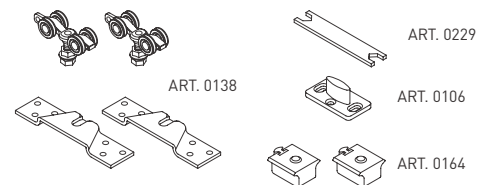

Doplnky za príplatok



ART. 0189 úchytka na montáž koľajnice na stenu



ART. 0251 profil pod dvere odporúčaný použiť v drážke na vodiaci trň



OVERTE
CENU

SC - KOMPONENTY 100 SILENT DO 40 KG SP2

	ks/set/m	Cena v €	
		bez DPH	s DPH
Profil horný vodiaci pre 100 SILENT, ART.0195	1 m	20,00	24,00
Balenie posuvného systému 100 SILENT SOFT, ART.0138P	1 set	38,00	45,60
Spomaľovač 2ks 100 SILENT do 40kg, ART. 0197	1 set	38,00	45,60
Úchytka pre montáž koľajnice 100 SILENT na stenu, ART. 0189	1 ks	2,00	2,40
Profil hliníkový pod dvere, ART. 0251	1 m	5,00	6,00

SÉRIA 100 SILENT

Riešenie pre dvojkrídlové posuvné dvere do 40 kg s obojstranným spomaľovačom

Komponenty, typy montáží
a doplnky - str. 361



SC - SET 100 SILENT S 2D 3000/40 SP2

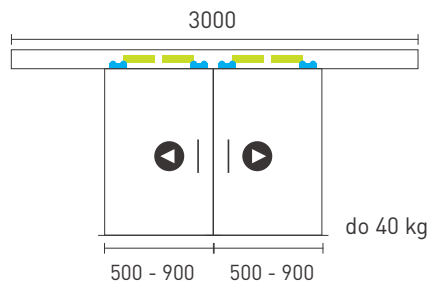

do 40 kg

SC - SET 100 SILENT S 2D 4000/40 SP2

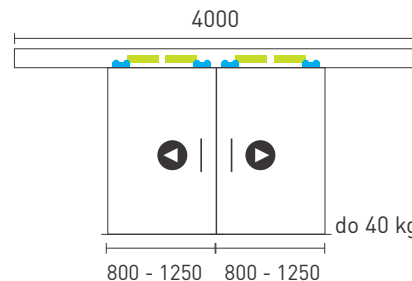

do 40 kg

Legenda

 - posuvný vozík

 - spomaľovač

  - smer otvárania



SC - SET 100 SILENT S 2D 3000/40 SP2

	Cena za set v €	bez DPH	s DPH
Balenie posuvného systému 2 sety			
Profil hliník 100 SILENT 3 m		212,00	254,40
Spomaľovač 4ks 100 SILENT do 40 kg			

SC - SET 100 SILENT S 2D 4000/40 SP2

	Cena za set v €	bez DPH	s DPH
Balenie posuvného systému 2 sety			
Profil hliník 100 SILENT 4 m		232,00	278,40
Spomaľovač 4ks 100 SILENT do 40 kg			

OVERTE
CENU

i Pre dverné krídlo menšie ako 720 mm je možné použiť iba 1 spomaľovač.

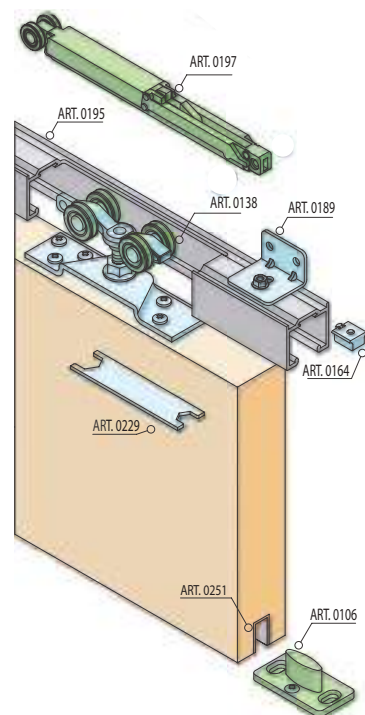

Balenie posuvného systému - 0138P

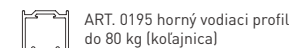
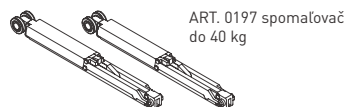
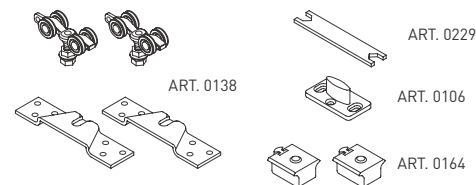

Doplnky za príplatok

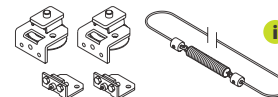
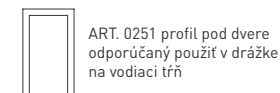
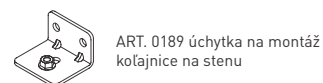

i ART. 1911 - 1913
Balenie doplnkového systému SINCRO.
Volitelný doplnok pre synchronizované
otváranie a zatváranie dvojkrídlových dverí.

SC - KOMPONENTY 100 SILENT DO 40 KG SP2



OVERTE
CENU

	ks/set/m	Cena v €	
		bez DPH	s DPH
Profil horný vodiaci pre 100 SILENT, ART.0195	1 m	20,00	24,00
Balenie posuvného systému 100 SILENT SOFT, ART.0138P	1 set	38,00	45,60
Spomaľovač 2ks 100 SILENT do 40kg, ART. 0197	1 set	38,00	45,60
Úchytka pre montáž koľajnice 100 SILENT na stenu, ART. 0189	1 ks	2,00	2,40
Balenie doplnkového systému SINCRO ART. 1911-1913	1 set	47,00	56,40
Profil hliníkový pod dvere, ART. 0251	1 m	5,00	6,00

SÉRIA 100 SILENT

Riešenie pre jednokrídlové posuvné dvere do 80 kg s obojstranným spomaľovačom

Komponenty, typy montáží
a doplnky - str. 363



SC - SET 100 SILENT S 1D 1500/80 SP

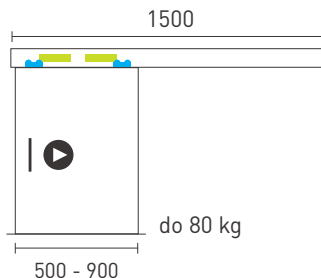

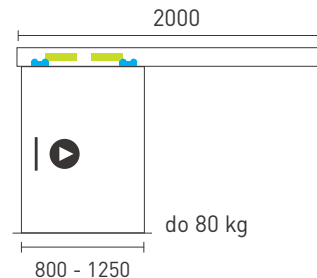

SC - SET 100 SILENT S 1D 2000/80 SP



Legenda

 - posuvný vozík

 - spomaľovač

  - smer otvárania



SC - SET 100 SILENT S 1D 1500/80 SP

	Cena za set v €	bez DPH	s DPH
Balenie posuvného systému 1 set			
Profil hliník 100 SILENT 1,5 m		116,00	139,20
Spomaľovač 2 ks 100 SILENT do 80 kg			

SC - SET 100 SILENT S 1D 2000/80 SP

	Cena za set v €	bez DPH	s DPH
Balenie posuvného systému 1 set			
Profil hliník 100 SILENT 2 m		126,00	151,20
Spomaľovač 2 ks 100 SILENT do 80 kg			

OVERTE
CENU

i Pre dverné krídlo menšie ako 720 mm je možné použiť iba 1 spomaľovač.

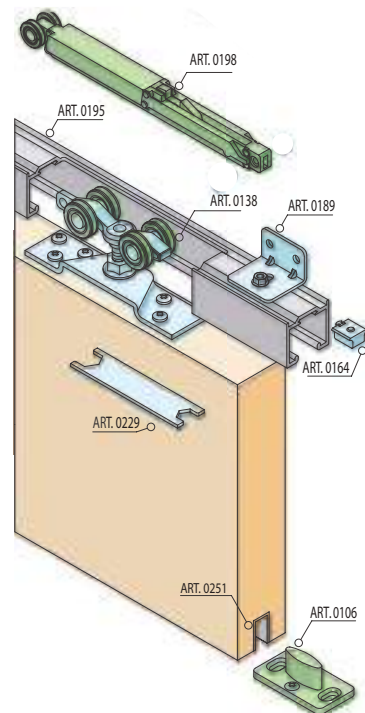

Balenie posuvného systému - 0138P

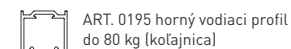
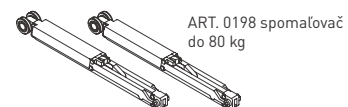
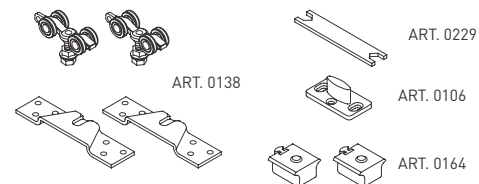

Doplňky za príplatok

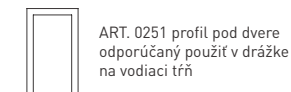
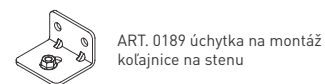

OVERTE
CENU

SC - KOMPONENTY 100 SILENT DO 80 KG SP2

	ks/set/m	Cena v €	
		bez DPH	s DPH
Profil horný vodiaci pre 100 SILENT, ART.0195	1 m	20,00	24,00
Balenie posuvného systému 100 SILENT SOFT, ART.0138P	1 set	38,00	45,60
Spomaľovač 2ks 100 SILENT do 80kg, ART. 0198	1 set	38,00	45,60
Úchytka pre montáž koľajnice 100 SILENT na stenu, ART. 0189	1 ks	2,00	2,40
Profil hliníkový pod dvere, ART. 0251	1 m	5,00	6,00

SÉRIA 100 SILENT
Riešenie pre dvojkrídlové posuvné dvere do 80 kg s obojstranným spomaľovačom

Komponenty, typy montáží
a doplnky - str. 365





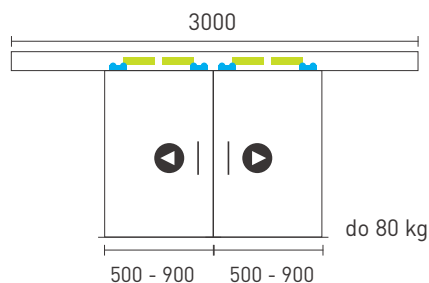

SC - SET 100 SILENT S 2D 3000/80 SP2

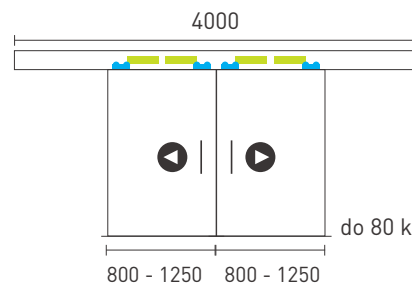

SC - SET 100 SILENT S 2D 4000/80 SP2



Legenda

-  - posuvný vozík
-  - spomaľovač
-   - smer otvárania



SC - SET 100 SILENT S 2D 3000/80 SP2

	Cena za set v €	bez DPH	s DPH
Balenie posuvného systému 2 sety			
Profil hliník 100 SILENT 3 m		232,00	278,40
Spomaľovač 4 ks 100 SILENT do 80 kg			

SC - SET 100 SILENT S 2D 4000/80 SP2

	Cena za set v €	bez DPH	s DPH
Balenie posuvného systému 2 sety			
Profil hliník 100 SILENT 4 m		252,00	302,40
Spomaľovač 4 ks 100 SILENT do 80 kg			

OVERTE
CENU

-  Pre dverné krídlo menšie ako 720 mm je možné použiť iba 1 spomaľovač.

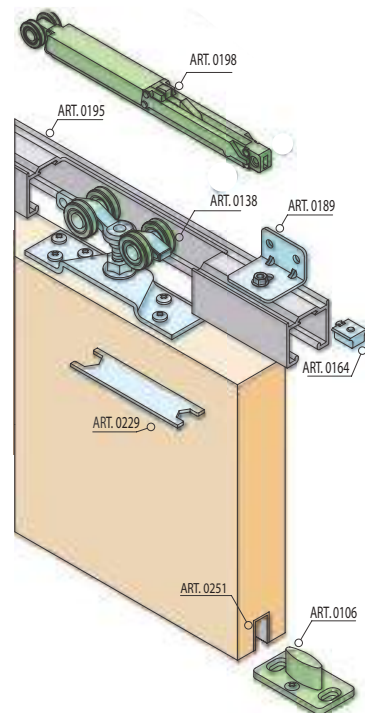

Balenie posuvného systému - 0138P

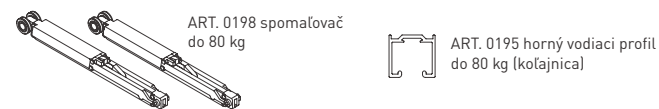
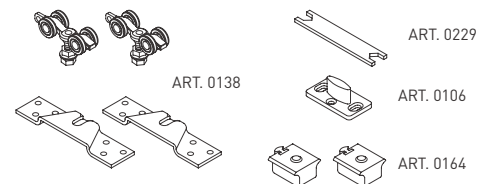

Doplňky za príplatok

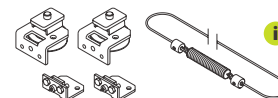
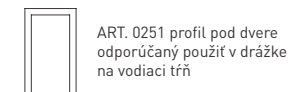
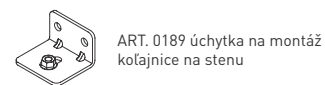

i ART. 1911 - 1913
Balenie doplnkového systému SINCRO.
Voliteľný doplnok pre synchronizované
otváranie a zatváranie dvojkrídlových dverí.



OVERTE
CENU

SC - KOMPONENTY 100 SILENT DO 80 KG SP2

	ks/set/m	Cena v €	
		bez DPH	s DPH
Profil horný vodiaci pre 100 SILENT, ART.0195	1 m	20,00	24,00
Balenie posuvného systému 100 SILENT SOFT, ART.0138P	1 set	38,00	45,60
Spomaľovač 2ks 100 SILENT do 80kg, ART. 0198	1 set	38,00	45,60
Úchytka pre montáž kolajnice 100 SILENT na stenu, ART. 0189	1 ks	2,00	2,40
Balenie doplnkového systému SINCRO ART. 1911-1913	1 set	47,00	56,40
Profil hliníkový pod dvere, ART. 0251	1 m	5,00	6,00

SÉRIA 1800 HIDDEN
Riešenie pre posuvné dvere so skrytým kovaním

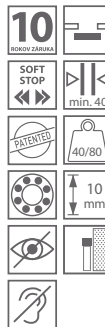
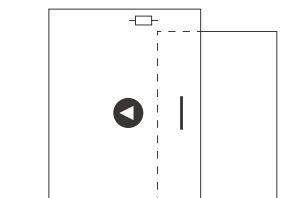
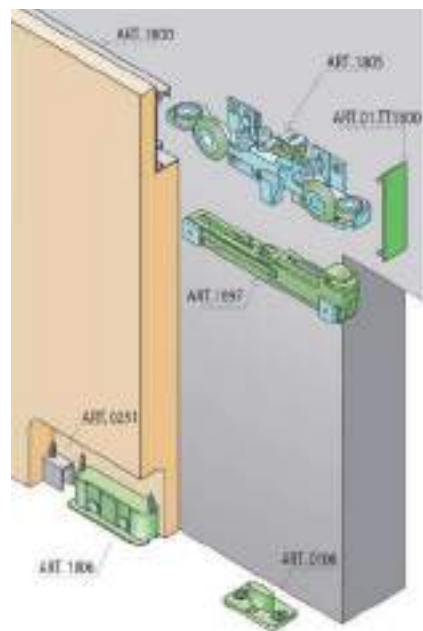

Balenie posuvného systému - 1800

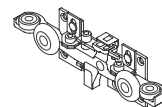

ART. 1805



ART. 01.TT.1800

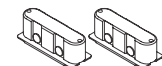

ART. 1806



ART. 0106

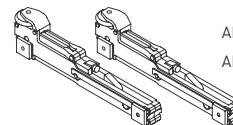

ART. 1897 spomaľovač do 40 kg

ART. 1898 spomaľovač do 80 kg



ART. 0251 profil pod dvere odporúčaný použiť v drážke na vodiaci trň



ART. 1800 skrytý vodiaci profil (koľajnica)



SC - POSUVNÝ SYSTÉM
1800 HIDDEN 40 / 80 KG SP

	Cena za set v €	bez DPH	s DPH
SET 1800 HIDDEN 1D 1530/40 + profil + SP		300,00	360,00
SET 1800 HIDDEN 1D 1530/80 + profil + SP		300,00	360,00

OVERTE
CENU



IN.15.901



NEM NEREZ MATNÁ (I)



BRM BRONZ MATNÝ (B)



CIM ČIERN A MATNÁ (N)

STN EN 1527

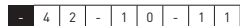

i Na drevené dvere



JNF - POSUVNÝ SYSTÉM IN.15.901

	Cena za set v €	bez DPH	s DPH
systém IN.15.901 (I) - NEM		141,50	169,80
systém IN.15.901 (B) - BRM		161,90	194,28
systém IN.15.901 (N) - CIM		172,20	206,64

OVERTE
CENU

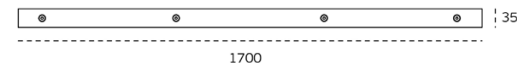
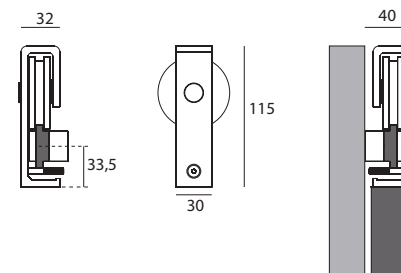

Balenie posuvného systému - IN.15.901

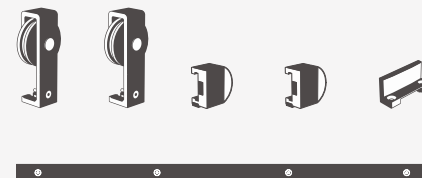



IN.15.903



NEM NEREZ MATNÁ (I)



BRM BRONZ MATNÝ (B)



CIM ČIERNÁ MATNÁ (N)

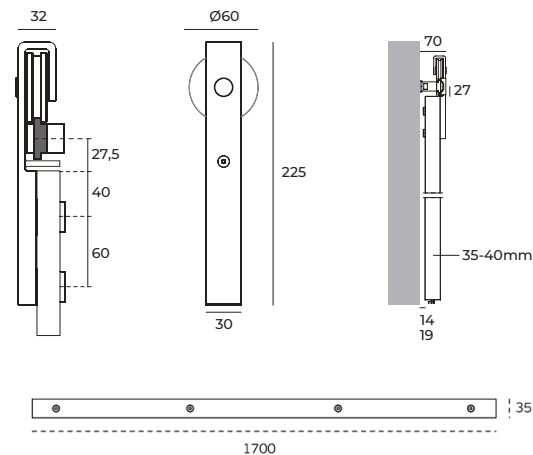

i Na drevené dvere



JNF - POSUVNÝ SYSTÉM IN.15.903

	Cena za set v €	bez DPH	s DPH
system IN.15.903 (I) - NEM		175,60	210,72
system IN.15.903 (B) - BRM		189,00	226,80
system IN.15.903 (N) - CIM		189,00	226,80

OVERTE
CENU

Balenie posuvného systému - IN.15.903

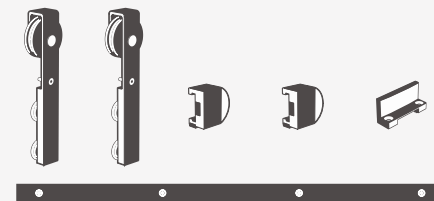



IN.15.900



BRM BRONZ
MATNÝ (B)



CIM ČIERNÁ
MATNÁ (N)

NEM NEREZ MATNÁ (I)

STN EN 1527

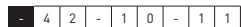

i Na sklenené dvere

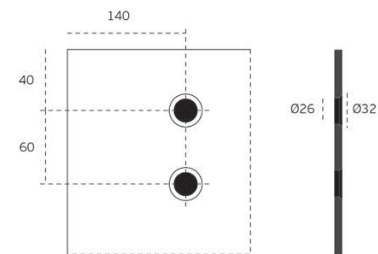
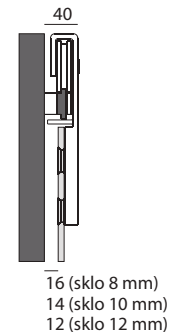
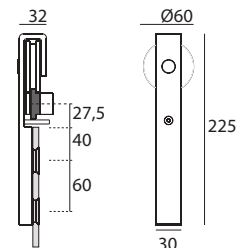

JNF - POSUVNÝ SYSTÉM IN.15.900 NA SKLO

	Cena za set v €	bez DPH	s DPH
system IN.15.900.I - NEM	122,00	146,40	
system IN.15.900.B - BRM	146,40	175,68	
system IN.15.900.N - CIM	170,80	204,96	
spomaľovač IN.15.900.S - NEM	62,00	74,40	

Balenie posuvného systému - IN.15.900

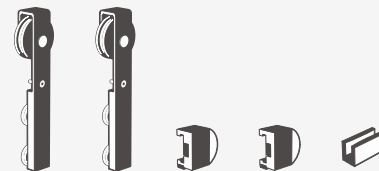

OVERTE
CENU



DOPLNKY

ZÁVESY, ZÁMKY, ZARÁŽKY,
STAVAČE, ZÁSTRČE





VYSVETLIVKY



predĺžená záruka 5 rokov



ľavoprávny zámok



montáž zarážky skrutkovaním samorezka



montáž skrutkovaním samorezka/metrický závit



maximálna váha dverného krídla v kg



CHM CHRÓM MATNÝ



CIM ČIERNA MATNÁ



BIM BIELA MATNÁ

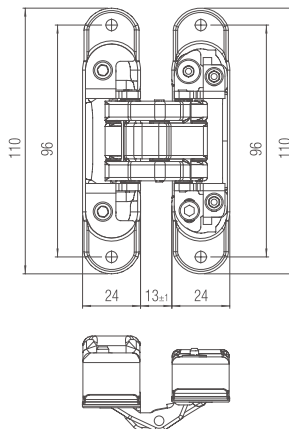
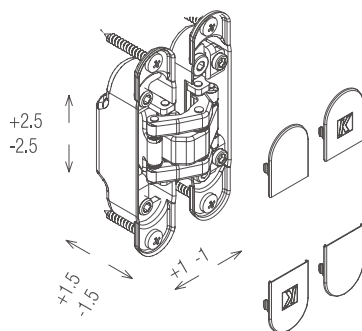

Nastaviteľná montážna podložka

- nastavenie pomocou vymedzovacích podložiek (polmesiačikov)

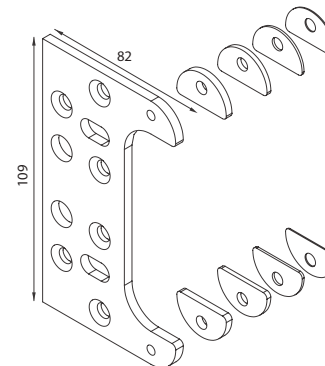

Kompletne 3D nastaviteľný záves pre bezfalcové dvere s masívnou drevenou, obložkovou, oceľovou alebo hliníkovou zárubňou.

Pre obložkovú zárubňu je potrebné použiť montážnu podložku, pre oceľovú a hliníkovú zárubňu montážnu kapsu.

Vhodné pre protipožiarne dvere s odolnosťou 30 minút!



KZ - SKRYTÝ ZÁVES ATOMIKA - K 8060/8080

	Cena za kus v €	bez DPH	s DPH
záves K 8060 CHM		19,20	23,04
záves K 8060 CIM		25,80	30,96
záves K 8080 BIM		52,50	63,00
nastaviteľná montážna podložka ku K 8060/8080	11,50	13,80	
frézovacia šablóna pre montáž ku K 8060/8080	64,20	77,04	
frézovací rám DIMA UNIVERSAL	507,10	608,52	

OVERTE CENU

- pravo-ľavé prevedenie, bezúdržbové ložiská, kompletne oceľové telo
- trojdimenzionálne nastavenie
 - stranové +/- 1,5 mm
 - výškové +/- 1,5 mm excentricky
 - prítlak +/- 1
- uhol otvorenia 180°
- nosnosť 60 kg (2 pánty)
- veľkosť 110 mm
- priemer frézy 16 mm,
- rozmer dveri 900 x 2100 mm
- minimálna hrúbka dveri 32 mm



CHM CHRÓM MATNÝ

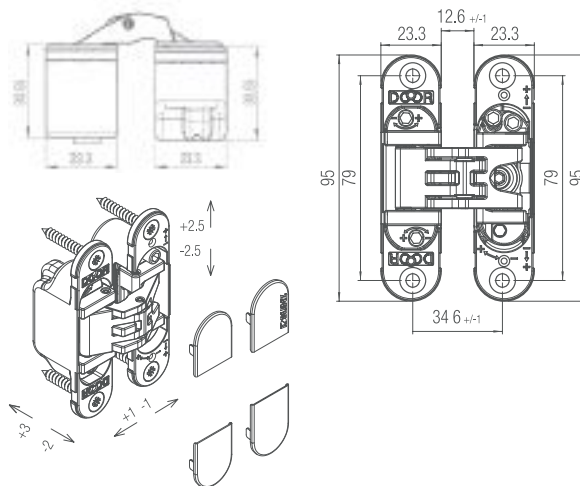

Kompletne 3D nastavitelný záves pre bezfalcové dvere s masívnou drevenu, obložkovou, oceľovou alebo hliníkovou zárubňou.

Vhodné pre protipožiarne dvere s odolnosťou 30 minút!



KZ - SKRYTÝ ZÁVES KUBICA - K 6200

	Cena za kus v €	bez DPH	s DPH
záves K 6200 CHM		36,80	44,16
frézovacia šablóna pre montáž ku K 6200	64,20		77,04
frézovací rám DIMA UNIVERSAL	507,10		608,52

OVERTE
CENU

- pravo-ľavé prevedenie, bezúdržbové ložiská
- trojdimenzionálne nastavenie
 - stranové $\pm 3/- 2$ mm
 - výškové $\pm 2,5$ mm excentricky
 - prítlak $\pm 1,0$ mm
- uhol otvorenia 180°
- nosnosť: 45 kg [2 pánty], 60 kg [3/4 pánty]
- veľkosť 95 mm
- priemer frézy 16 mm
- rozmer dverí 600/900 x 2100 mm
- minimálna hrúbka dverí 32 mm
- certifikát UL a ULC



CHM CHRÓM MATNÝ



CIM ČIERNA MATNÁ



BIM BIELA MATNÁ

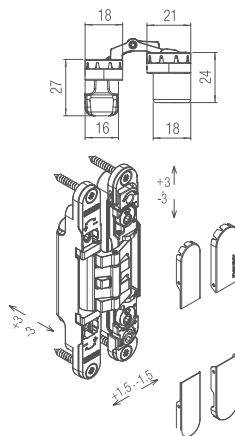
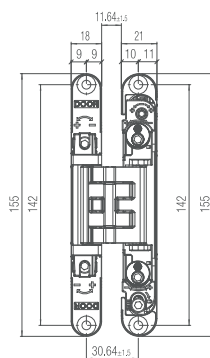

Nastaviteľná montážna podložka

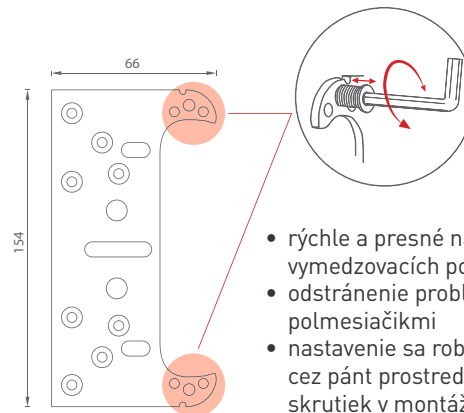

- rýchle a presné nastavenie bez použitia vymedzovacích polmesiačikov
- odstránenie problému s padajúcimi polmesiačikmi
- nastavenie sa robí s imbusovým kľúčom cez pánt prostredníctvom integrovaných skrutiek v montážnej podložke

Kompletne 3D nastaviteľný záves pre bezfalcové dvere s masívnou drevenou, obložkovou, oceľovou alebo hliníkovou zárubňou.

Pre obložkovú zárubňu je potrebné použiť montážnu podložku, pre oceľovú a hliníkovú zárubňu montážnu kapsu.

Vhodné pre protipožiarne dvere s odolnosťou 30 minút!



KZ - SKRYTÝ ZÁVES KUBICA - K 2460

	Cena za kus v €	bez DPH	s DPH
záves K 2460 CHM		36,40	43,68
záves K 2460 CIM		40,80	48,96
záves K 2460 BIM		48,60	58,32
nastaviteľná montážna podložka ku K 2460	8,30		9,96
frézovacia šablóna pre montáž ku K 2460	128,30		153,96
frézovací rám DIMA UNIVERSAL	507,10		608,52

- pravo-ľavé prevedenie, bezúdržbové ložiská
- trojdimenzionálne nastavenie
 - stranové +/- 3 mm
 - výškové +/- 3 mm excentricky
 - prítlak +/- 1,5 mm
- uhol otvorenia 180°
- nosnosť: 60 kg (2 pánty)
- veľkosť 155 mm
- priemer frézy 16 mm
- rozmer dverí 600/900 x 2100 mm
- minimálna hrúbka dverí 25 mm

OVERTE CENU

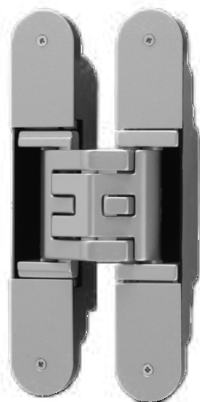

CHM CHRÓM MATNÝ



CIM ČIERNÁ MATNÁ

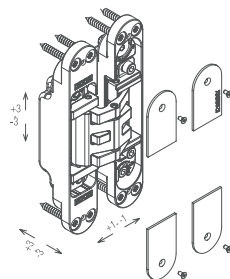
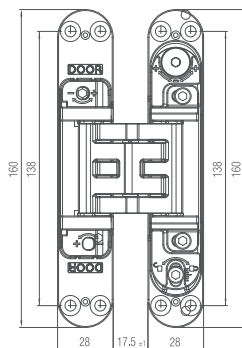

Nastaviteľná montážna podložka

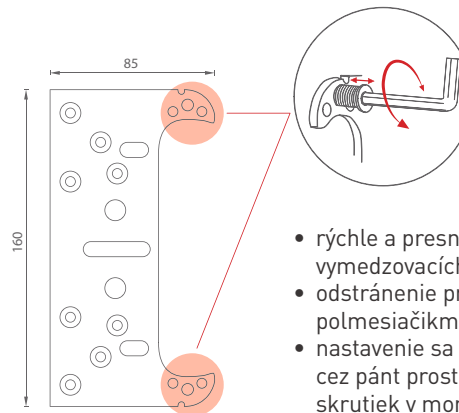

- rýchle a presné nastavenie bez použitia vymedzovacích polmesiačikov
- odstránenie problému s padajúcimi polmesiačikmi
- nastavenie sa robí s imbusovým kľúčom cez pánt prostredníctvom integrovaných skrutiek v montážnej podložke

Kompletne 3D nastaviteľný záves pre bezfalcové dvere s masívnou drevenou, obložkovou, oceľovou alebo hliníkovou zárubňou.

Pre obložkovú zárubňu je potrebné použiť montážnu podložku, pre oceľovú a hliníkovú zárubňu montážnu kapsu.

Vhodné pre protipožiarne dvere s odolnosťou 30 minút!



KZ - SKRYTÝ ZÁVES KUBICA - K 5080

	Cena za kus v €	
	bez DPH	s DPH
záves K 5080 CHM	47,50	57,00
záves K 5080 CIM	56,60	67,92
nastaviteľná montážna podložka ku K 5080	9,70	11,64
frézovacia šablóna pre montáž ku K 5080	64,20	77,04
frézovací rám DIMA UNIVERSAL	507,10	608,52

- pravo-ľavé prevedenie, bezúdržbové ložiská
- trojdimenzionálne nastavenie stranové +/- 3 mm
- výškové +/- 3 mm excentricky
- prítlak +/- 1 mm
- uhol otvorenia 180°
- nosnosť: 80 kg (2 pánty)
- veľkosť 160 mm
- priemer frézy 16 mm
- rozmer dverí 600/900 x 2100 mm
- minimálna hrúbka dverí 25 mm
- certifikát UL a ULC

OVERTE
CENU

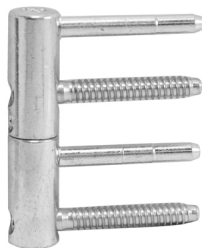

POB POZINK BIELY



BRM BRONZ MATNÝ (BP)

495/14

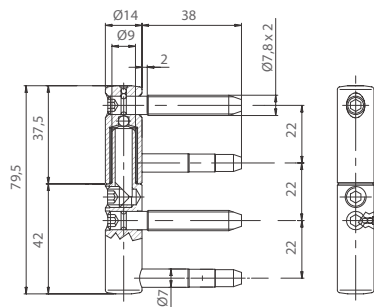

495/16

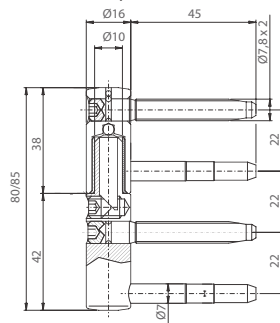

495/20

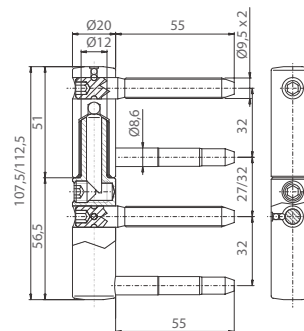

OV - ZÁVES 495

	POB		BRM	
	Cena za kus v €		bez DPH	s DPH
spodný 495/Ø14	1,90	2,28	2,90	3,48
spodný 495/Ø16	4,50	5,40	3,30	3,96
spodný 495/Ø20	4,50	5,40	-	-
vrchný 495/Ø14	1,70	2,04	2,00	2,40
vrchný 495/Ø16	3,00	3,60	2,60	3,12
vrchný 495/Ø20	3,70	4,44	-	-

OTVORTE
CENU

DOPLNKY



BIL BIELA LESKLÁ (MWP)



NIL NIKEL LESKLÝ



ZLL ZLATÁ LESKLÁ



GRM GRAFIT MATNÝ



CIM ČIERNA MATNÁ (MBP)

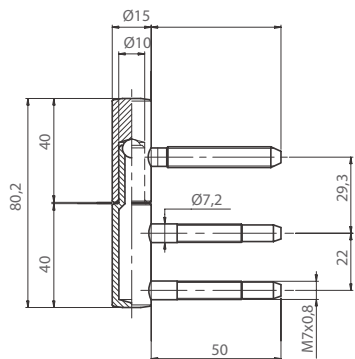

OV - JR 519
taška na záves



OV - ZÁVES 101/100	NIL, ZLL		BIL, CIM		GRM	
	Cena za kus v €		Cena za kus v €		Cena za kus v €	
	bez DPH	s DPH	bez DPH	s DPH	bez DPH	s DPH
spodný 101/Ø15	1,50	1,80	2,00	2,40	3,30	3,96
vrchný 100/Ø15	0,90	1,08	1,20	1,44	2,80	3,36

OV - TAŠKA NA ZÁVES JR 519	Cena za kus v €	
	bez DPH	s DPH
taška na záves	0,90	1,08

OVERTE
CENU



POB POZINK BIELY



POB POZINK BIELY



POB POZINK BIELY

protiplech

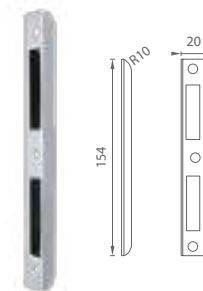

POB POZINK BIELY

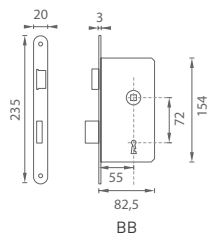

BB

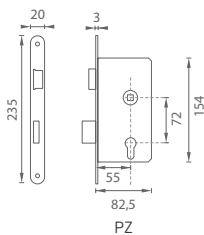

PZ

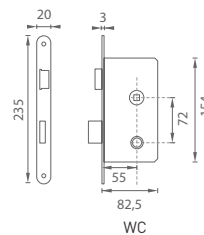

WC



MP - ZÁMOK 72

		Cena za kus v €	bez DPH	s DPH
zámok BB 72			10,00	12,00
zámok PZ 72			10,00	12,00
zámok WC 72			10,00	12,00
protiplech			1,50	1,80



OVERTE
CENU

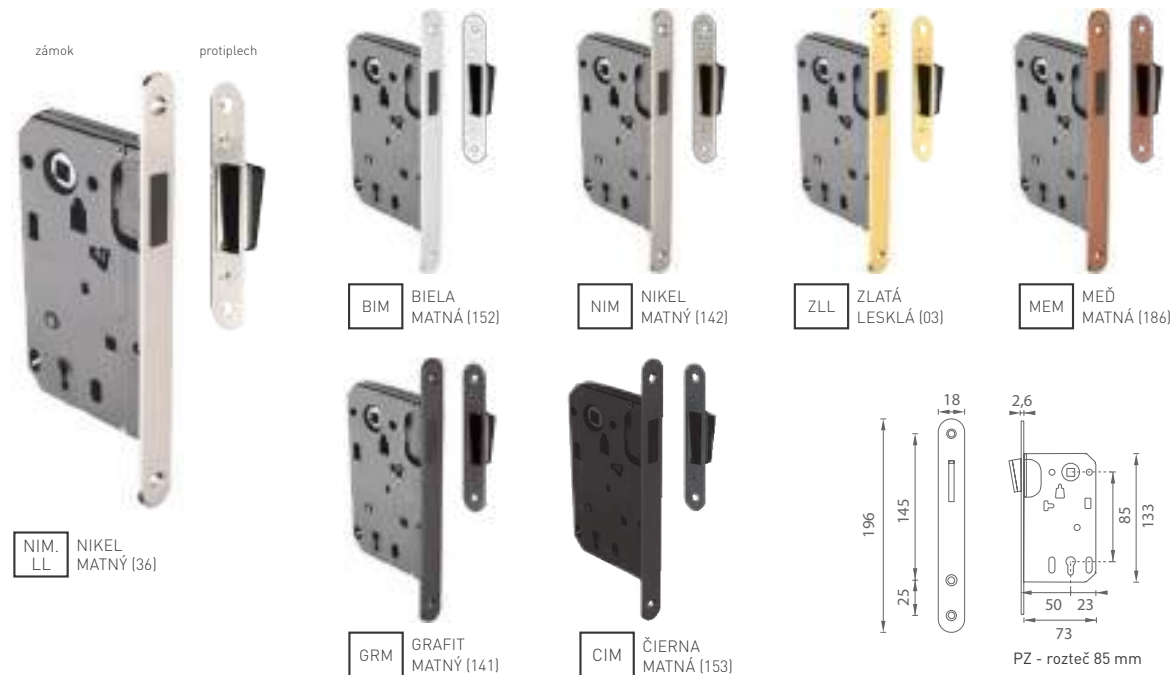

i protiplech je nastaviteľný 1,5 mm do každej strany

i Súčasťou balenia BB zámku je kľúč



TI - MAGNETICKÝ ZÁMOK

Cena za kus v €	NIM.LL, CIM, ZLL, BIM		NIM, MEM, GRM	
	bez DPH	s DPH	bez DPH	s DPH
Magnetický zámok 2867 BB 90	16,00	19,20	20,00	24,00
Magnetický zámok 2868 PZ 85	15,00	18,00	19,00	22,80
Magnetický zámok 2869 WC 90	15,00	18,00	19,00	22,80
Protiplech k magnetickému zámku	4,00	4,80	4,00	4,80

OVERTE
CENU

i magnetický zámok

5
ROKOV ZÁRUKA

Li Re



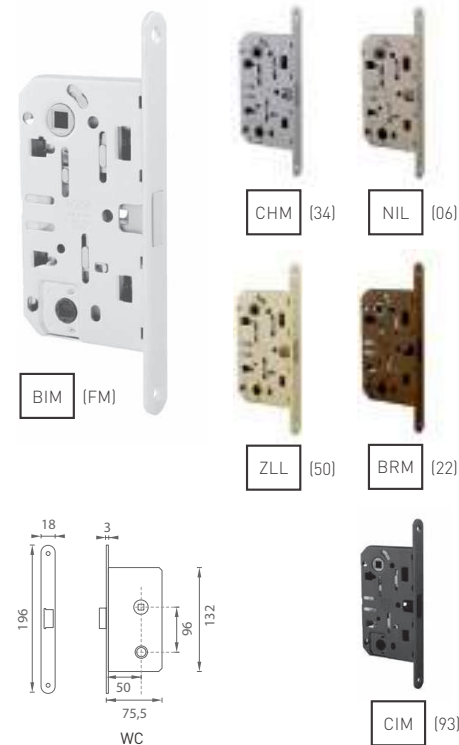
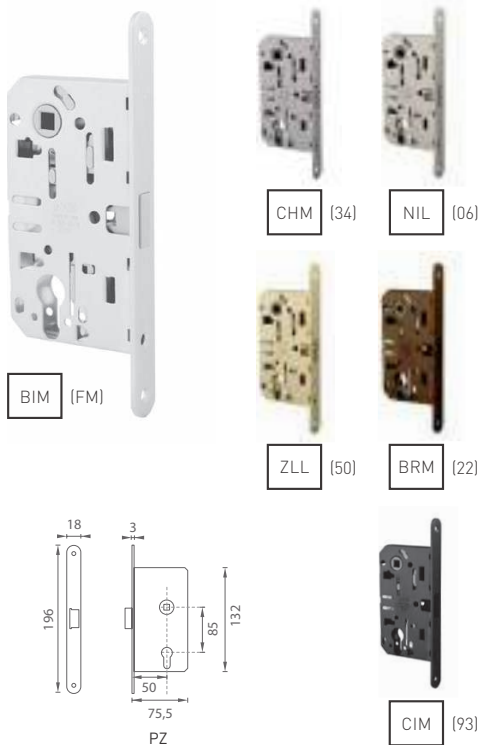
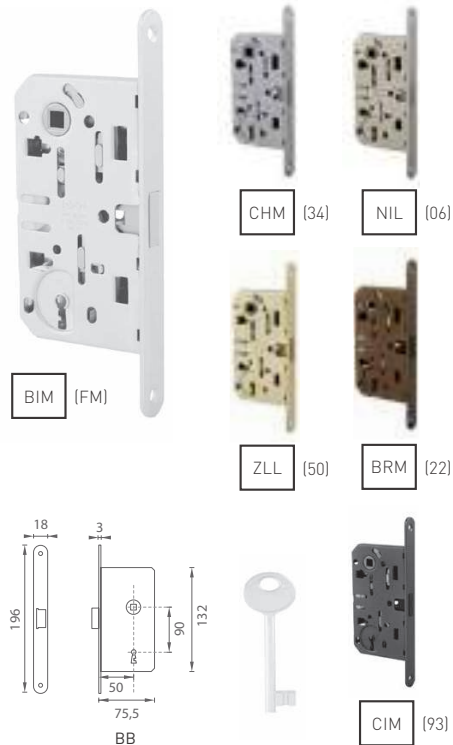

**AGB - MAGNETICKÝ ZÁMOK
MEDIANA POLARIS**

Cena za kus v €	BRM, ZLL		NIL		CHM		BIM, CIM	
	bez DPH	s DPH	bez DPH	s DPH	bez DPH	s DPH	bez DPH	s DPH
Magnetický zámok BB 90	17,50	21,00	20,30	24,36	21,90	26,28	24,40	29,28
Magnetický zámok PZ 85	19,70	23,64	22,40	26,88	24,00	28,80	26,70	32,04
Magnetický zámok WC 96	18,90	22,68	21,60	25,92	23,20	27,84	25,90	31,08



**OVERTE
CENU**

i magnetický zámok

1. protiplech nastaviteľný s magnetickou vaničkou



i vanička s magnetom je v cene protiplechu

2. protiplech s magnetickou vaničkou



i vanička s magnetom je v cene protiplechu

3. protikus nastaviteľný magnetický pre drevenú zárubňu



4. protikus nastaviteľný magnetický pre hliníkovú zárubňu

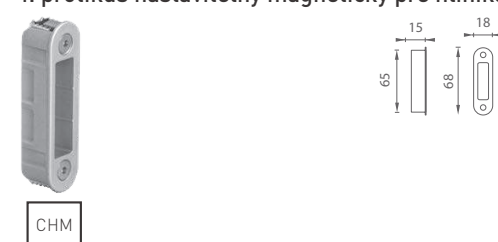

**AGB - PROTIPLECH
MEDIANA POLARIS**

Cena za set v €	BRM		ZLL, NIL		CHM		BIM, CIM	
	bez DPH	s DPH	bez DPH	s DPH	bez DPH	s DPH	bez DPH	s DPH
1. protiplech nastaviteľný s magnetickou vaničkou	5,60	6,72	5,90	7,08	7,10	8,52	7,40	8,88
2. protiplech s magnetickou vaničkou	5,60	6,72	5,90	7,08	7,10	8,52	-	-
3. protikus nastaviteľný magnetický pre drevenú zárubňu	-	-	5,30	6,36	5,30	6,36	4,50	5,40
4. protikus nastaviteľný magnetický pre hliníkovú zárubňu	-	-	-	-	9,60	11,52	-	-

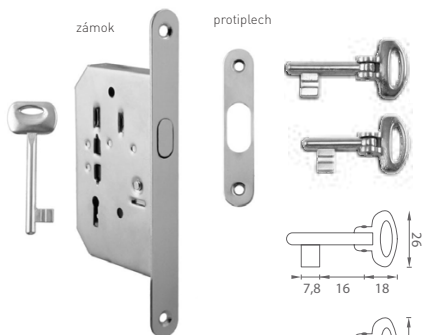
OVERTE
CENU

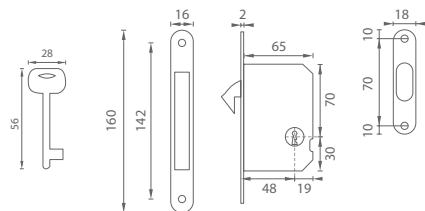
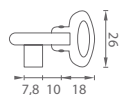

CHL CHRÓM LESKLÝ (F04)



CHM CHRÓM MATNÝ (F05)



NIL NIKEL LESKLÝ (F28)



ZLL ZLATÁ LESKLÁ (F01)



BRM.LL BRONZ MATNÝ (F03)



BRM BRONZ MATNÝ (F43)



SIA SIVÁ ANTIK (F45)



CIM ČIERNA MATNÁ (FNO)

i BB kľúč a protiplech sú súčasťou balenia v danej povrchovej úprave



FT - ZÁMOK NA POSUVNÉ DVERE - BB 60/50

Cena za kus v €	BRM.LL, NIL		ZLL		CHL		CHM		BRM		CIM, SIA	
	bez DPH	s DPH	bez DPH	s DPH	bez DPH	s DPH	bez DPH	s DPH	bez DPH	s DPH	bez DPH	s DPH
zámok BB 60/50	12,00	14,40	12,00	14,40	14,00	16,80	14,00	16,80	21,50	25,80	21,50	25,80
zalamovací BB kľúč dlhý	-	-	6,50	7,80	6,50	7,80	-	-	6,50	7,80	-	-
zalamovací BB kľúč krátky	-	-	6,50	7,80	6,50	7,80	-	-	6,50	7,80	-	-

OVERTE CENU

Zámky je možné kombinovať do setu s mušľami FT, TI, PR.





CHL CHRÓM LESKLÝ (F04)

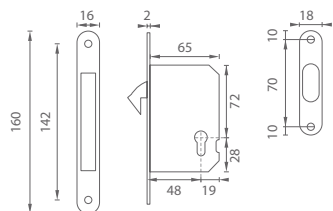

CHM CHRÓM MATNÝ (F05)



NIL NIKEL LESKLÝ (F28)



ZLL ZLATÁ LESKLÁ (F01)



BRM.LL BRONZ MATNÝ (F03)



BRM BRONZ MATNÝ (F43)



SIA SIVÁ ANTIK (F45)



CIM ČIERNA MATNÁ (FNO)

i Protiplech je súčasťou balenia v danej povrchovej úprave



FT - ZÁMOK NA POSUVNÉ DVERE - PZ 62/50

Cena za kus v €	BRM.LL, NIL, ZLL		CHL, CHM		CIM, SIA		BRM	
	bez DPH	s DPH	bez DPH	s DPH	bez DPH	s DPH	bez DPH	s DPH
zámok PZ 62/50	10,00	12,00	12,00	14,40	16,00	19,20	19,00	22,80

OVERTE CENU

Zámky je možné kombinovať do setu s muškami FT, TI, PR.



CHL CHRÓM LESKLÝ (F04)

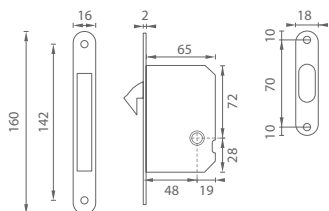

CHM CHRÓM
MATNÝ (F05)



NIL NIKEL
LESKLÝ (F28)



ZLL ZLATÁ
LESKLÁ (F01)



BRM.
LL BRONZ
MATNÝ (F03)



BRM BRONZ
MATNÝ (F43)



SIA SIVÁ ANTIK (F45)



CIM ČIERNA
MATNÁ (F00)

i Protiplech je súčasťou balenia v danej povrchovej úprave



FT - ZÁMOK NA POSUVNÉ DVERE - WC 61/50

Cena za kus v €	BRM.LL, NIL, ZLL		CHL, CHM		CIM, SIA		BRM	
	bez DPH	s DPH	bez DPH	s DPH	bez DPH	s DPH	bez DPH	s DPH
zámok WC 61/50 	10,00	12,00	12,00	14,40	16,00	19,20	19,00	22,80

OVERTE CENU

Zámky je možné kombinovať do setu s muškami FT, TI, PR.



CHL CHRÓM
LESKLÝ (03)



BIM BIELA
MATNÁ (152)



CHM CHRÓM
MATNÝ (96)



NIM NIKEL
MATNÝ (142)



NIM.
LL NIKEL
MATNÝ (36)



BRM BRONZ
MATNÝ (77)



GRM GRAFIT MATNÝ
(141)



CIM ČIERNA
MATNÁ (153)

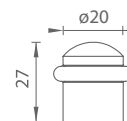

MATERIÁL: MOSADZ



Podstavec slúži pre uchytenie dvernej zarážky o podlahu nalepením a je dostupný vo všetkých farebných prevedeniach.



TI - ZARÁŽKA DVERÍ OVÁLNA - 115

	Cena za kus v €	
	bez DPH	s DPH
oválna zarážka 115	7,00	8,40
podstavec pod zarážku 115	4,50	5,40



OVERTE
CENU



CHL CHRÓM
LESKLÝ (03)



BIM BIELA
MATNÁ (152)



CHM CHRÓM
MATNÝ (96)



NIM NIKEL
MATNÝ (142)



BRM BRONZ
MATNÝ (77)



GRM GRAFIT MATNÝ
(141)



CIM ČIERNA
MATNÁ (153)

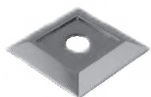
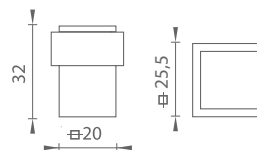

Podstavec slúži pre uchytenie dvernej zarážky o podlahu nalepením a je dostupný vo všetkých farebných prevedeniach.



MATERIÁL: ZAMAK



TI - ZARÁŽKA DVERÍ HRANATÁ - 2617

	Cena za kus v €	bez DPH	s DPH
hranatá zarážka 2617		11,50	13,80
podstavec pod zarážku 2617		4,70	5,64



OVERTE
CENU

IN.13.121.T.20



NEM NEREZ MATNÁ

IN.13.121.20



NEM NEREZ MATNÁ



CIM.PVD ČIERNÁ MATNÁ (TB)

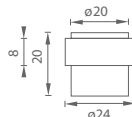

MP polkopolka



NEM NEREZ MATNÁ

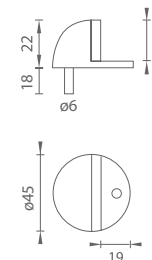

IN.13.121.30 ECO



NEM NEREZ MATNÁ

IN.13.121.30



CIM.PVD ČIERNÁ MATNÁ (TB)

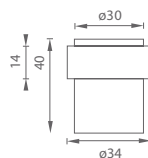

MATERIÁL: NEREZ



OVERTE
CENU

JNF - ZARÁŽKA DVERÍ - IN.13.121.20

	Cena za kus v €	bez DPH	s DPH
IN.13.121.T.20 - NEM		2,80	3,36
IN.13.121.20 - NEM		3,00	3,60
IN.13.121.20 - CIM.PVD		6,50	7,80
IN.13.121.30.ECO - NEM		7,20	8,64
IN.13.121.30 - CIM.PVD		11,80	14,16



MP - ZARÁŽKA DVERÍ - POLKOPULKA

	Cena za kus v €	bez DPH	s DPH
MP - polkopolka		3,50	4,20



ERGO FORM IN.13.006



IN.13.185.30



NEM NEREZ MATNÁ

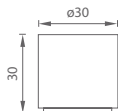
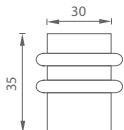

ALFA IN.13.106.20



IN.13.106.25



IN.13.122



NEM NEREZ MATNÁ

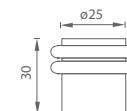
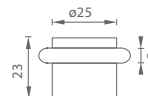
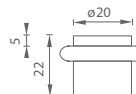

MATERIÁL: NEREZ



JNF - ZARÁŽKA DVERÍ OVÁLNA

	Cena za kus v €	bez DPH	s DPH
ERGO FORM IN.13.006		7,30	8,76
IN.13.185.30		10,70	12,84



JNF - ZARÁŽKA DVERÍ OVÁLNA

	Cena za kus v €	bez DPH	s DPH
IN.13.106.20		2,20	2,64
IN.13.106.25		3,10	3,72
IN.13.122		6,80	8,16



OVERTE
CENU



STM STRIEBORNÁ
MATNÁ

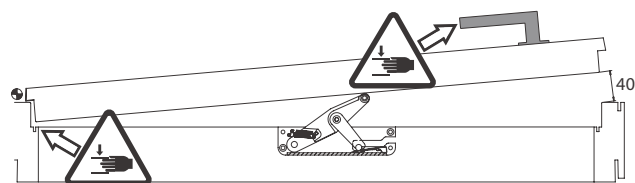
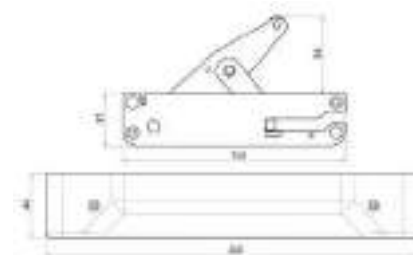

Pohľad z hora

i SALVADITA - zabraňuje zabuchnutiu dverného krídla



OV - BEZPEČNOSTNÁ POISTKA - SALVADITA

	Cena za kus v €	bez DPH	s DPH
SALVADITA - STM		148,50	178,20



OVERTE
CENU



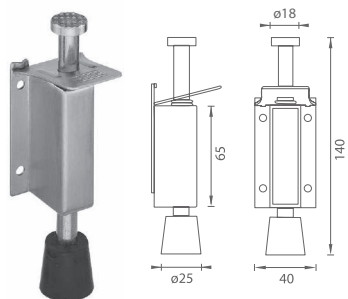

IN.23.125

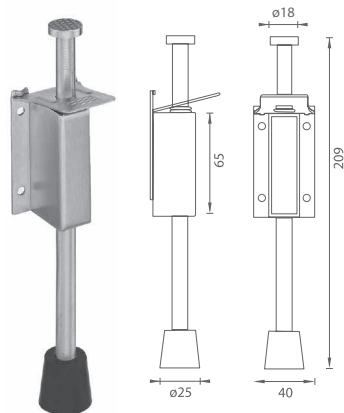

IN.23.126

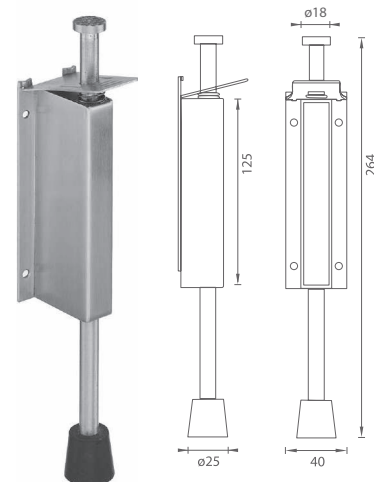

IN.23.127



JNF - STAVAČ DVERÍ

	Cena za kus v €	bez DPH	s DPH
stavač dverí - IN.23.125		13,20	15,84
stavač dverí - IN.23.126		16,20	19,44
stavač dverí - IN.23.127		20,80	24,96

OVERTE
CENU



CHM

CHRÓM
MATNÝ (34)

NIL

NIKEL
LESKLÝ (06)

ZLL

ZLATÁ
LESKLÁ (03)

BRM

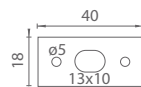
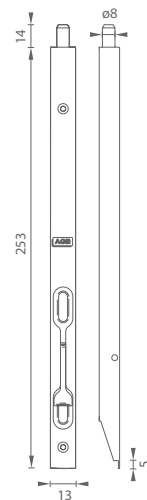
BRONZ
MATNÝ (02)Protikus je súčasťou
balenia

CHM

CHRÓM
MATNÝ (34)

NIL

NIKEL
LESKLÝ (06)

POB

BIELY
POZINK (05)

POZ

POZINK
ŽLTÝ (04)

ZLL

ZLATÁ
LESKLÁ (03)

BRM

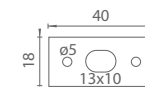
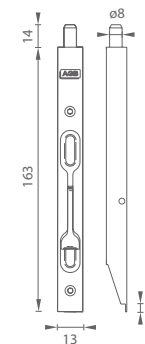
BRONZ
MATNÝ (02)Protikus je súčasťou
balenia

AGB - ZÁSTRČ DVERÍ F16 - H250

	Cena za kus v €	
	bez DPH	s DPH
zástrč F16 H250 - CHM	6,50	7,80
zástrč F16 H250 - NIL	5,00	6,00
zástrč F16 H250 - ZLL	4,60	5,52
zástrč F16 H250 - BRM	4,50	5,40

OVERTE
CENU

AGB - ZÁSTRČ DVERÍ F16 - H150

	Cena za kus v €	
	bez DPH	s DPH
zástrč F16 H150 - CHM	6,00	7,20
zástrč F16 H150 - NIL	4,50	5,40
zástrč F16 H150 - POB	3,40	4,08
zástrč F16 H150 - POZ	3,40	4,08
zástrč F16 H150 - ZLL	4,10	4,92
zástrč F16 H150 - BRM	3,80	4,56



DOPLNKY
TESNIACE LIŠTY
A DVERNÉ PRAHY

VYSVETLIVKY TESNIACE LIŠTY



dlhá životnosť



Produkt certifikovaný
na protihlukové dvere v dB



pre protipožiarne
a dymotesné dvere

VYSVETLIVKY PRAHY



Olejovanie – na povrchovú úpravu prahov je použitý voskový olej Osmo, ktorý po vyschnutí zanechá tvrdý a odolný povrch. Jednoduchá oprava v prípade poškodenia. Na prahy sú nanášané 2 vrstvy oleja.



Lakovanie – na povrchovú úpravu prahov je použitý vysoko-odolný polyuretánový, transparentný lak Adler. Na prahy sú nanášané 2 vrstvy laku.



Morenie – na dosiahnutie rôznych odtieňov prahov sú použité farebne stále moridlá Sirca.



Bez povrchovej úpravy – prah je možné prispôsobiť farebným odtieňom podľa vlastných požiadaviek.



Kartáčovanie (kefovanie) – mechanicky zvýraznená kresba dreva, tzv. vykartáčovanie mäkkších, jarných vlákien.



Brúsenie – povrch je zarovnaný a vyhladený brúsením. Je pripravený na povrchovú úpravu.



i Lištu je možné skrátiť o max. 200 mm.
Lišta je testovaná na 200 000 cyklov.

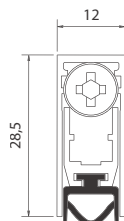

Maximálny výšuv je 13 mm.

Určené pre dvere v prevedení			
DREVO	OCEĽ	HLINÍK	PVC

i Lištu je možné skrátiť o max. 200 mm.
Lišta je testovaná na 200 000 cyklov.

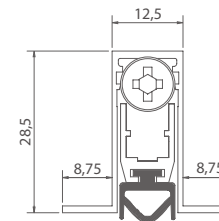

Maximálny výšuv je 13 mm.

Určené pre dvere v prevedení			
DREVO	OCEĽ	HLINÍK	PVC



OVERTE
CENU

CO - PRAHOVÁ VÝSUVNÁ LIŠTA - 422

	dĺžka v mm	Cena za kus v €	bez DPH	s DPH
prahová výsuvná lišta	630		15,60	18,72
prahová výsuvná lišta	730		16,10	19,32
prahová výsuvná lišta	830		16,70	20,04
prahová výsuvná lišta	930		17,20	20,64
prahová výsuvná lišta	1030		17,70	21,24
prahová výsuvná lišta	1130		18,20	21,84



CO - PRAHOVÁ VÝSUVNÁ LIŠTA - 520

	dĺžka v mm	Cena za kus v €	bez DPH	s DPH
prahová výsuvná lišta	630		15,70	18,84
prahová výsuvná lišta	730		16,20	19,44
prahová výsuvná lišta	830		16,70	20,04
prahová výsuvná lišta	930		17,20	20,64
prahová výsuvná lišta	1030		17,70	21,24
prahová výsuvná lišta	1130		18,30	21,96





- i** Lištu je možné skrátiť o max. 100 mm.
Lišta je testovaná na 200 000 cyklov.

Určené pre dvere v prevedení			
DREVO	OCEĽ	HLINÍK	PVC

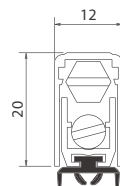

Maximálny výšuv je 13 mm.



- i** Lištu je možné skrátiť o max. 100 mm.
Lišta je testovaná na 200 000 cyklov.

Určené pre dvere v prevedení			
DREVO	OCEĽ	HLINÍK	PVC

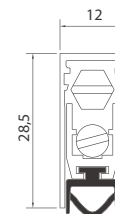

Maximálny výšuv je 18 mm.



OVERTE
CENU

CO - PRAHOVÁ VÝSUVNÁ LIŠTA - 1700 MINI

	dĺžka v mm	Cena za kus v €	bez DPH	s DPH
prahová výšuvná lišta	630		21,10	25,32
prahová výšuvná lišta	730		21,80	26,16
prahová výšuvná lišta	830		22,30	26,76
prahová výšuvná lišta	930		22,90	27,48
prahová výšuvná lišta	1030		23,50	28,20
prahová výšuvná lišta	1130		24,10	28,92



CO - PRAHOVÁ VÝSUVNÁ LIŠTA - 1712

	dĺžka v mm	Cena za kus v €	bez DPH	s DPH
prahová výšuvná lišta	630		23,50	28,20
prahová výšuvná lišta	730		24,10	28,92
prahová výšuvná lišta	830		24,70	29,64
prahová výšuvná lišta	930		25,40	30,48
prahová výšuvná lišta	1030		25,90	31,08
prahová výšuvná lišta	1130		26,60	31,92





i Lištu je možné skrátiť o max. 100 mm.
Lišta je testovaná na 200 000 cyklov.

i Lištu je možné skrátiť o max. 100 mm.
Lišta je testovaná na 200 000 cyklov.

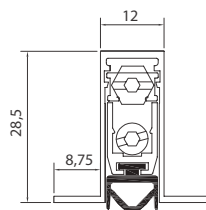

Maximálny výšuv je 18 mm.

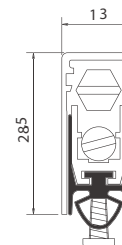

Maximálny výšuv je 18 mm.

Určené pre dvere v prevedení

DREVO	OCEĽ	HLINÍK	PVC
-------	------	--------	-----

Určené pre dvere v prevedení

DREVO	OCEĽ	HLINÍK	PVC
-------	------	--------	-----



CO - PRAHOVÁ VÝSUVNÁ LIŠTA - 1812

	dĺžka v mm	Cena za kus v €	bez DPH	s DPH
prahová výšuvná lišta	630		26,40	31,68
prahová výšuvná lišta	730		27,00	32,40
prahová výšuvná lišta	830		27,60	33,12
prahová výšuvná lišta	930		28,20	33,84
prahová výšuvná lišta	1030		28,80	34,56
prahová výšuvná lišta	1130		29,40	35,28



OVERTE
CENU

CO - PRAHOVÁ VÝSUVNÁ LIŠTA - 1773 ACU

	dĺžka v mm	Cena za kus v €	bez DPH	s DPH
prahová výšuvná lišta	630		31,60	37,92
prahová výšuvná lišta	730		32,20	38,64
prahová výšuvná lišta	830		32,80	39,36
prahová výšuvná lišta	930		33,40	40,08
prahová výšuvná lišta	1030		34,00	40,80
prahová výšuvná lišta	1130		34,60	41,52





- i** Lištu je možné skrátiť o max. 100 mm.
Lišta je testovaná na 200 000 cyklov.

Určené pre dvere v prevedení

DREVO	OCEĽ	HLINÍK	PVC
-------	------	--------	-----

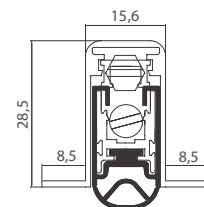

Maximálny výšuv je 18 mm.



- BIM - BIELA MATNÁ ● STM - STRIEBORNÁ MATNÁ
● BRM - BRONZ MATNÝ ● HNM - HNEDÁ MATNÁ

- i** Lištu je možné skrátiť o max. 100 mm.
Lišta je testovaná na 200 000 cyklov.

Určené pre dvere v prevedení

DREVO	OCEĽ	HLINÍK	PVC
-------	------	--------	-----

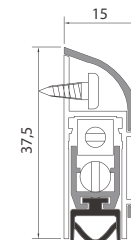

Maximálny výšuv je 13mm.



CO - PRAHOVÁ VÝSUVNÁ LIŠTA - 1800 XNS

	dĺžka v mm	Cena za kus v €	bez DPH	s DPH
prahová výsuvná lišta	630		49,40	59,28
prahová výsuvná lišta	730		50,50	60,60
prahová výsuvná lišta	830		51,60	61,92
prahová výsuvná lišta	930		52,70	63,24
prahová výsuvná lišta	1030		53,80	64,56
prahová výsuvná lišta	1130		54,90	65,88



OVERTE
CENU

CO - PRAHOVÁ VÝSUVNÁ LIŠTA - 1750

	dĺžka v mm	Cena za kus v €	bez DPH	s DPH
prahová výsuvná lišta	630		34,50	41,40
prahová výsuvná lišta	730		35,20	42,24
prahová výsuvná lišta	830		35,90	43,08
prahová výsuvná lišta	930		36,60	43,92
prahová výsuvná lišta	1030		37,30	44,76
prahová výsuvná lišta	1130		38,10	45,72





DUB

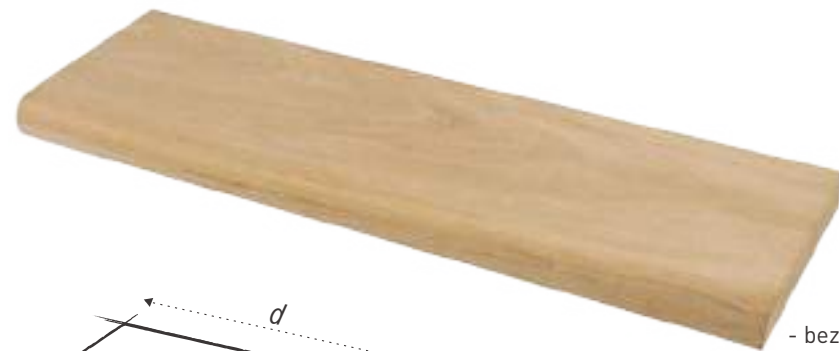

- bez povrchovej úpravy

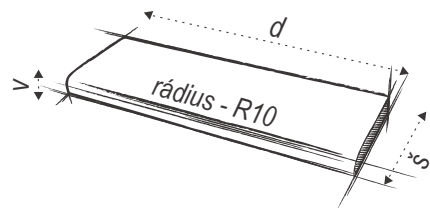

i Štandardná výška prahu je 2 cm

TESNENIE



B - BÉŽOVÁ



H - HNEDÁ

i Štandardne je dodávaný prah bez drážky a tesnenia. Silikónové tesnenie **B - béžová** alebo **H - hnedá**, v cene 2,00 € bez DPH, resp. 2,40 € s DPH za 1 m.



OVERTE
CENU

TD - DREVENÝ PRAH DUB - BRÚSENÝ

šírky prahu (cm)	Cena za kus v €	dĺžky prahu (cm)*										
		60	70	80	90	100	110	120	130	140	150	160
8	bez DPH	9,80	11,50	13,10	14,70	16,40	18,00	19,70	21,30	26,60	31,40	34,10
	s DPH	11,76	13,80	15,72	17,64	19,68	21,60	23,64	25,56	31,92	37,68	40,92
9 a 10	bez DPH	10,20	11,90	13,60	15,20	17,00	18,70	20,30	22,00	30,80	33,00	35,30
	s DPH	12,24	14,28	16,32	18,24	20,40	22,44	24,36	26,40	36,96	39,60	42,36
11 a 12	bez DPH	12,00	14,00	16,00	18,00	20,00	22,00	24,00	26,00	36,40	39,00	41,60
	s DPH	14,40	16,80	19,20	21,60	24,00	26,40	28,80	31,20	43,68	46,80	49,92
13 a 14	bez DPH	14,10	16,40	18,80	21,20	23,50	25,90	28,20	30,60	42,80	45,80	48,90
	s DPH	16,92	19,68	22,56	25,44	28,20	31,08	33,84	36,72	51,36	54,96	58,68
15 a 16	bez DPH	16,00	18,70	21,30	24,00	26,60	29,30	32,00	34,60	48,50	51,90	55,40
	s DPH	19,20	22,44	25,56	28,80	31,92	35,16	38,40	41,52	58,20	62,28	66,48

* prahy sú štandardne dlhšie o 1-1,5 cm z dôvodu presného osadenia (potrebné upraviť pri montáži)



i Prah s osadeným tesnením na objednávku.



DUB



Prírodný - 02



Orech - 08



Wenge - 09

TESNENIE



B - BÉŽOVÁ



H - HNEDÁ

- i** Štandardne je dodávaný prah bez drážky a tesnenia. Silikónové tesnenie **B - béžová** alebo **H - hnedá**, v cene 2,00 € bez DPH, resp. 2,40 € s DPH za 1 m.

- i** Štandardná výška prahu je 2 cm



OVERTE
CENU

TD - DREVENÝ PRAH DUB - MORENÝ A LAKOVANÝ

šírky prahu (cm)	Cena za kus v €	dĺžky prahu (cm)*										
		60	70	80	90	100	110	120	130	140	150	160
8	bez DPH	11,00	12,80	14,70	16,50	18,40	19,20	22,10	23,90	33,40	35,80	38,20
	s DPH	13,20	15,36	17,64	19,80	22,08	23,04	26,52	28,68	40,08	42,96	45,84
9 a 10	bez DPH	11,50	13,40	15,40	17,30	19,20	20,10	23,10	25,00	35,00	37,50	40,70
	s DPH	13,80	16,08	18,48	20,76	23,04	24,12	27,72	30,00	42,00	45,00	48,84
11 a 12	bez DPH	13,40	15,70	17,90	20,10	22,40	23,40	26,90	29,10	40,70	43,60	46,50
	s DPH	16,08	18,84	21,48	24,12	26,88	28,08	32,28	34,92	48,84	52,32	55,80
13 a 14	bez DPH	14,50	16,90	19,40	21,80	24,20	25,30	29,00	31,40	44,00	47,10	50,30
	s DPH	17,40	20,28	23,28	26,16	29,04	30,36	34,80	37,68	52,80	56,52	60,36
15 a 16	bez DPH	16,40	19,10	21,80	24,50	27,20	30,00	32,70	38,60	49,60	53,10	56,70
	s DPH	19,68	22,92	26,16	29,40	32,64	36,00	39,24	46,32	59,52	63,72	68,04

* prahy sú štandardne dlhšie o 1-1,5 cm z dôvodu presného osadenia (potrebné upraviť pri montáži)



- i** Prah s osadeným tesnením na objednávku.





DUB



Med - 13



Jantár - 14



Rustik - 15



Hnedá zem - 16



Grafit - 17

TESNENIE



B - BÉŽOVÁ



H - HNEDÁ

- i** Štandardne je dodávaný prah bez drážky a tesnenia. Silikónové tesnenie **B - béžová** alebo **H - hnedá**, v cene 2,00 € bez DPH, resp. 2,40 € s DPH za 1 m.

i Štandardná výška prahu je 2 cm



OVERTE
CENU

TD - DREVENÝ PRAH DUB - KARTÁČOVANÝ A OLEJOVANÝ

šírky prahu (cm)	Cena za kus v €	dĺžky prahu (cm)*										
		60	70	80	90	100	110	120	130	140	150	160
8	bez DPH	12,10	14,10	16,20	18,20	20,20	22,20	24,20	26,30	36,80	39,40	42,00
	s DPH	14,52	16,92	19,44	21,84	24,24	26,64	29,04	31,56	44,16	47,28	50,40
9 a 10	bez DPH	12,70	14,80	16,90	19,00	21,10	23,20	25,30	27,50	38,40	41,20	43,90
	s DPH	15,24	17,76	20,28	22,80	25,32	27,84	30,36	33,00	46,08	49,44	52,68
11 a 12	bez DPH	15,00	17,60	20,00	22,60	25,10	27,60	30,10	32,60	45,60	48,80	52,10
	s DPH	18,00	21,12	24,00	27,12	30,12	33,12	36,12	39,12	54,72	58,56	62,52
13 a 14	bez DPH	17,60	20,60	23,50	26,40	29,40	32,30	35,20	38,20	53,40	57,20	61,10
	s DPH	21,12	24,72	28,20	31,68	35,28	38,76	42,24	45,84	64,08	68,64	73,32
15 a 16	bez DPH	20,90	24,30	27,80	31,30	34,70	38,20	41,70	45,20	66,20	70,70	75,30
	s DPH	25,08	29,16	33,36	37,56	41,64	45,84	50,04	54,24	79,44	84,84	90,36

* prahy sú štandardne dlhšie o 1-1,5 cm z dôvodu presného osadenia (potrebné upraviť pri montáži)



- i** Prah s osadeným tesnením na objednávku.





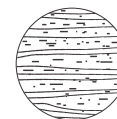

BUK

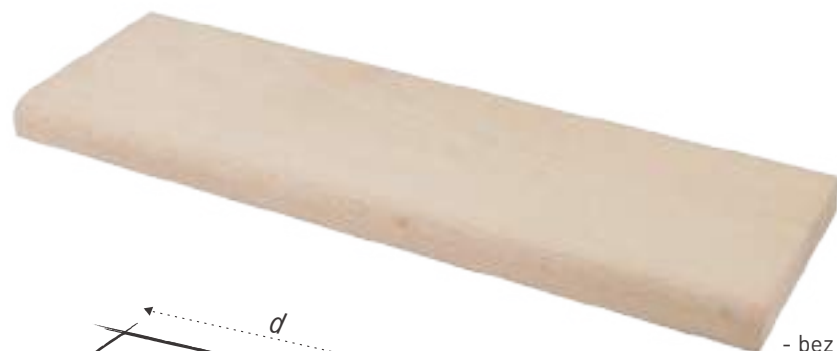

- bez povrchovej úpravy

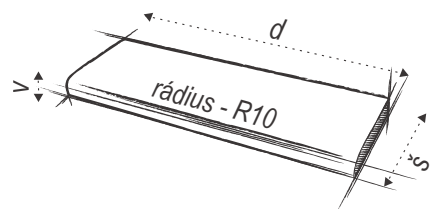

i Štandardná výška prahu je 2 cm

TESNENIE



i Štandardne je dodávaný prah bez drážky a tesnenia. Silikónové tesnenie **B - béžová** alebo **H - hnedá**, v cene 2,00 € bez DPH, resp. 2,40 € s DPH za 1 m.



OVERTE
CENU

TD - DREVENÝ PRAH BUK - BRÚSENÝ

šírky prahu (cm)	Cena za kus v €	dĺžky prahu (cm)*										
		60	70	80	90	100	110	120	130	140	150	160
8	bez DPH	7,80	9,20	10,40	11,80	13,10	14,30	15,70	17,00	23,70	25,40	27,10
	s DPH	9,36	11,04	12,48	14,16	15,72	17,16	18,84	20,40	28,44	30,48	32,52
9 a 10	bez DPH	8,50	9,90	11,30	12,70	14,10	15,60	17,00	18,40	25,80	27,60	29,40
	s DPH	10,20	11,88	13,56	15,24	16,92	18,72	20,40	22,08	30,96	33,12	35,28
11 a 12	bez DPH	9,20	10,70	12,20	13,70	15,20	16,80	18,30	19,80	27,80	29,70	31,70
	s DPH	11,04	12,84	14,64	16,44	18,24	20,16	21,96	23,76	33,36	35,64	38,04
13 a 14	bez DPH	10,10	11,80	13,40	15,20	16,80	18,50	20,20	21,90	30,60	32,80	35,00
	s DPH	12,12	14,16	16,08	18,24	20,16	22,20	24,24	26,28	36,72	39,36	42,00
15 a 16	bez DPH	11,30	13,20	15,10	17,00	18,80	20,70	22,60	24,50	34,30	36,70	41,80
	s DPH	13,56	15,84	18,12	20,40	22,56	24,84	27,12	29,40	41,16	44,04	50,16

* prahy sú štandardne dlhšie o 1-1,5 cm z dôvodu presného osadenia (potrebné upraviť pri montáži)



i Prah s osadeným tesnením na objednávku.





Prírodný - 00



Jelša - 03



Malaga - 06



Orech svetlý - 10



Parený - 01



Čerešňa - 05



Orech - 07



Morgana - 11

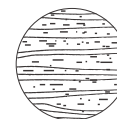

BUK

TESNENIE



B - BÉŽOVÁ



H - HNEDÁ

- i** Štandardne je dodávaný prah bez drážky a tesnenia. Silikónové tesnenie **B - béžová** alebo **H - hnedá**, v cene 2,00 € bez DPH, resp. 2,40 € s DPH za 1 m.

- i** Štandardná výška prahu je 2 cm



OVERTE
CENU

TD - DREVENÝ PRAH BUK - MORENÝ A LAKOVANÝ

šírky prahu (cm)	Cena za kus v €	dĺžky prahu (cm)*										
		60	70	80	90	100	110	120	130	140	150	160
8	bez DPH	8,80	10,30	11,80	13,20	14,70	16,20	17,60	19,10	26,80	28,70	30,60
	s DPH	10,56	12,36	14,16	15,84	17,64	19,44	21,12	22,92	32,16	34,44	36,72
9 a 10	bez DPH	9,80	11,40	13,00	14,60	16,30	17,90	19,50	21,20	29,60	31,70	33,80
	s DPH	11,76	13,68	15,60	17,52	19,56	21,48	23,40	25,44	35,52	38,04	40,56
11 a 12	bez DPH	10,30	12,00	13,70	15,50	17,20	18,90	20,60	22,30	31,30	33,50	35,70
	s DPH	12,36	14,40	16,44	18,60	20,64	22,68	24,72	26,76	37,56	40,20	42,84
13 a 14	bez DPH	12,30	13,10	14,90	16,80	18,70	20,50	22,40	24,30	33,90	36,40	38,80
	s DPH	14,76	15,72	17,88	20,16	22,44	24,60	26,88	29,16	40,68	43,68	46,56
15 a 16	bez DPH	12,40	14,40	16,50	18,50	20,60	22,70	24,70	26,80	37,50	40,20	42,80
	s DPH	14,88	17,28	19,80	22,20	24,72	27,24	29,64	32,16	45,00	48,24	51,36

* prahy sú štandardne dlhšie o 1-1,5 cm z dôvodu presného osadenia (potrebné upraviť pri montáži)



- i** Prah s osadeným tesnením na objednávku.

DOPLNKY
SAMOZATVÁRAČE



AKO VYBRAŤ SAMOZATVÁRAČ

K správne mu výberu samozatvárača je potrebné poznať:

1. šírku a výšku dverného krídla
2. použitie a frekvenciu otvárania/zatvárania
3. materiál dverí
4. dizajn - typ

Upozornenie

Pri výbere samozatvárača je nevyhnutné dodržať požiadavky normy STN EN 1154, ktorá stanovuje veľkosť samozatvárača (zatváraciu silu) vzhľadom na šírku dverného krídla.

Sila samozatvárača			Šírka dverného krídla podľa EN (mm)	
Podľa EN	od	do		
1*		750		
2*	750	850		
3	850	950		
4	950	1100		
5	1100	1250		
6	1250	1400		
7	1400	1600		

*Nesmie byť nastavená na protipožiarnych dverách

KLASIFIKAČNÝ KLÚČ PODĽA EN1154



VYSVETLIVKY



samozatvárače spĺňajú požiadavky normy STN EN 1154 a sú testované na min. 500 000 zatváracích cyklov



max. váha dverného krídla



sila dverného samozatvárača (môže byť nastaviteľná alebo fixná)



hrúbka dverí v mm



pre protipožiarne a dymotesné dvere



certifikát



max. šírka dverného krídla

VOLITEĽNÉ FUNKCIE



elektromagnetická aretácia (TS 3000E, TS 5000E, E ISM lišta, Boxer E ISM lišta)



elektromagnetická aretácia s dymovým čidlom (TS 3000R, TS 5000R, R ISM lišta)



s oneskoreným zatváraním (TS 4000S, TS 5000S)

GEZE



STM STRIEBORNÁ
MATNÁ (EV1)



BIM BIELA MATNÁ
(RAL 9016)



ZLM ZLATÁ MATNÁ
(RAL 1036)



HNM HNEDÁ MATNÁ



CIM ČIERNA MATNÁ
(RAL 9005)

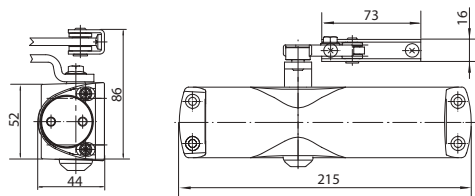

STN EN 1154



GZ - SAMOZATVÁRAČ TS - 1000

Cena za set v €	STM, BIM, HNM		CIM		ZLM, RAL	
	bez DPH	s DPH	bez DPH	s DPH	bez DPH	s DPH
samozatvárač s ramienkom	42,10	50,52	54,60	65,52	☎	
samozatvárač s aretačným ramienkom	76,50	91,80	90,70	108,84	☎	



**OVERTE
CENU**

Pre zvýšenie kvality montáže odporúčame použiť montážnu podložku.

☎ cena a dodací termín na vyžiadanie

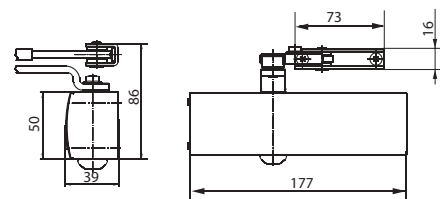
STM STRIEBORNÁ
MATNÁ (EV1)

STN EN 1154

4 8 3-4 1 1 3

BIM BIELA MATNÁ
(RAL 9016)ZLM ZLATÁ MATNÁ
(RAL 1036)

HNM HNEDÁ MATNÁ

CIM ČIERNA MATNÁ
(RAL 9005)

RAL FARBY

**GZ - SAMOZATVÁRAČ TS - 1500**

	STM, BIM, HNM		CIM		ZLM, RAL	
	bez DPH	s DPH	bez DPH	s DPH	bez DPH	s DPH
samozatvárač s ramienkom	62,10	74,52	79,00	94,80	☎	
samozatvárač s aretačným ramienkom	86,30	103,56	100,80	120,96	☎	

Cena za set v €

STN EN
11543-4
SILAOVERTE
CENU

Pre zvýšenie kvality montáže odporúčame použiť montážnu podložku.

☎ cena a dodací termín na vyžiadanie



STM STRIEBORNÁ
MATNÁ (EV1)



BIM BIELA MATNÁ
(RAL 9016)



ZLM ZLATÁ MATNÁ
(RAL 1036)



HNM HNEDÁ MATNÁ



CIM ČIERNA MATNÁ
(RAL 9005)

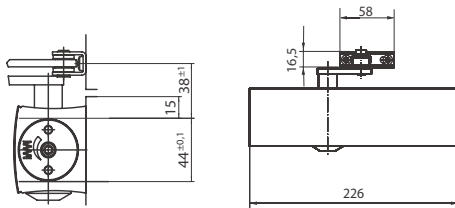

STN EN 1154

4	8	1-4	1	1	4
---	---	-----	---	---	---



RAL FARBY



GZ - SAMOZATVÁRAČ TS - 2000 NV	STM, BIM, HNM, CIM		ZLM, RAL	
	Cena za set v €		bez DPH	s DPH
samozatvárač s ramienkom	80,40	96,48	☎	
samozatvárač s aretačným ramienkom	115,00	138,00	☎	
samoz. s vypínateľným aretačným ramienkom	115,00	138,00	☎	

OVERTE
CENU

Pre zvýšenie kvality montáže odporúčame použiť montážnu podložku.



☎ cena a dodací termín na vyžiadanie

STM STRIEBORNÁ
MATNÁ (EV1)BIM BIELA MATNÁ
(RAL 9016)ZLM ZLATÁ MATNÁ
(RAL 1036)

HNM HNEDÁ MATNÁ

ANM ANTRACIT MATNÝ
(RAL 7016)CIM ČIERNA MATNÁ
(RAL 9005)

RAL FARBY

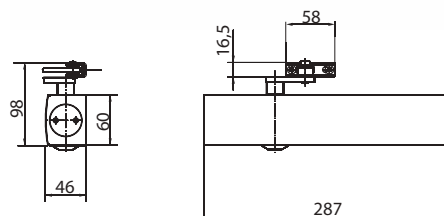

STN EN 1154

4 8 1-6 1 1 4

**GZ - SAMOZATVÁRAČ TS - 4000**

Cena za set v €	STM, BIM, HNM		CIM		ANM		ZLM, RAL	
	bez DPH	s DPH	bez DPH	s DPH	bez DPH	s DPH	bez DPH	s DPH
samozatvárač s ramienkom	142,50	171,00	163,80	196,56	211,80	254,16		
samozatvárač s aretačným ramienkom	174,40	209,28	200,00	240,00	226,00	271,20		
samoz. s vypínateľným aretačným ramienkom	174,40	209,28	200,00	240,00	233,50	280,20		

**OVERTE
CENU**

Pre zvýšenie kvality montáže odporúčame použiť montážnu podložku.



☎ cena a dodací termín na vyžiadanie

GEZE



STM STRIEBORNÁ
MATNÁ (EV1)

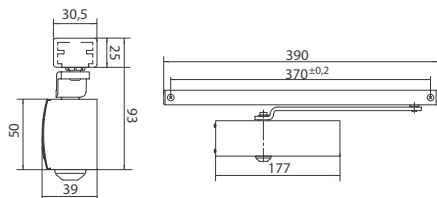

BIM BIELA MATNÁ
(RAL 9016)



ZLM ZLATÁ MATNÁ
(RAL 1036)



HNM HNEDÁ MATNÁ



CIM ČIERNA MATNÁ
(RAL 9005)



RAL FARBY



GZ - SAMOZATVÁRAČ TS - 1500 G

	STM, BIM, HNM		CIM		ZLM, RAL	
	bez DPH	s DPH	bez DPH	s DPH	bez DPH	s DPH
samozatvárač s klznou lištou	78,20	93,84	96,80	116,16		☎
samozatvárač s klznou lištou s aretáciou	95,90	115,08	121,20	145,44		☎

Cena za set v €

**OVERTE
CENU**

V prípadoch, keď nie je možné samozatvárač pripevniť na krídlo dverí odporúčame použiť montážnu podložku.

2

ROKY ZÁRUKA



STN EN
1154



750

☎ cena a dodací termín na vyžiadanie

GEZE

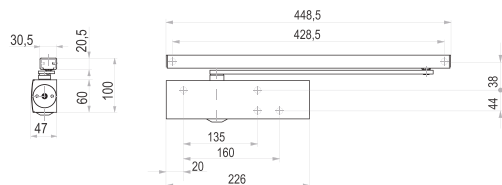
STM STRIEBORNÁ
MATNÁ (EV1)

STN EN 1154

4 8 1-4 1 1 4

BIM BIELA MATNÁ
(RAL 9016)ZLM ZLATÁ MATNÁ
(RAL 1036)

HNM HNEDÁ MATNÁ

ANM ANTRACIT MATNÝ
(RAL 7016)CIM ČIERNÁ MATNÁ
(RAL 9005)

RAL FARBY



GZ - SAMOZATVÁRAČ TS - 3000

	STM, BIM, HNM		CIM		ANM		ZLM, RAL	
	bez DPH	s DPH	bez DPH	s DPH	bez DPH	s DPH	bez DPH	s DPH
samozatvárač s klznou lištou	156,00	187,20	156,00	187,20	173,10	207,72		☎
samozatvárač s BG klznou lištou*	156,00	187,20	156,00	187,20	177,40	212,88		☎

OVERTE
CENU

*Lišta pre montáž na stranu oproti pántom.



☎ cena a dodací termín na vyziadanie

GEZE



STM STRIEBORNÁ
MATNÁ (EV1)

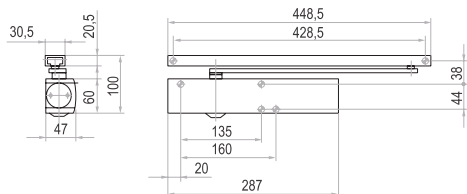

STN EN 1154

4	8	2-6	1	1	4
---	---	-----	---	---	---



BIM BIELA MATNÁ
(RAL 9016)



ZLM ZLATÁ MATNÁ
(RAL 1036)



HNM HNEDÁ MATNÁ



ANM ANTRACIT MATNÝ
(RAL 7016)



CIM ČIERNA MATNÁ
(RAL 9005)



RAL FARBY



**GZ - SAMOZATVÁRAČ
TS - 5000, TS - 5000 L**

Cena za set v €	STM, BIM, HNM, ANM, CIM		ZLM, RAL	
	bez DPH	s DPH	bez DPH	s DPH
samozatvárač s klznou lištou	299,70	359,64	☎	
samozatvárač L s klznou BG lištou	299,70	359,64	-	-

OVERTE
CENU

2 ROBY ZÁRUKA

CE

STN EN 1154

2-6 SILA

E

R

1400+

120 kg

BF

☎ cena a dodací termín na vyžiadanie



DOPLNKY

PANIKOVÉ
KOVANIA



1 - BODOVÉ ZAISTENIE

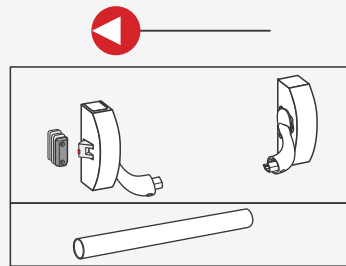

PHA 2000

2 - BODOVÉ ZAISTENIE

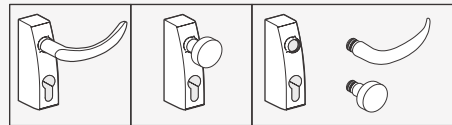
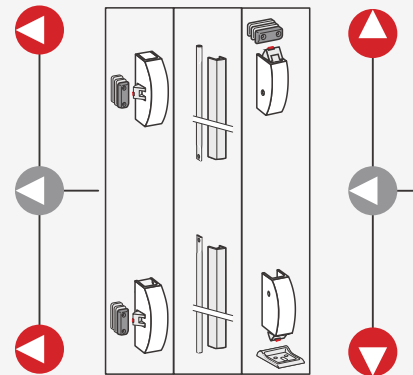

+ PHT

VYSVETLIVKY



je nutné použiť samozatvárač



pre protipožiarne a dymotesné dvere

BEZPEČNOSTNÁ POISTKA

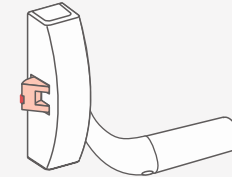

Bezpečnostná poistka zamedzuje zasunutiu západky späť v uzatvorenom stave dverí neoprávnenými osobami.

DENNÉ ZAISTENIE

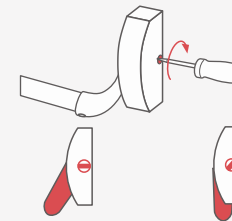

zatvorené

otvorené

Pokiaľ je aktívne denné zaistenie, je západka zatiahnutá a zaistená - dvere sú voľne priechodné.

JEDNOTLIVÉ KOMPONENTY PRE PHA 2000

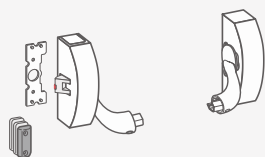

PHA 2102 F

- 1-bodové zaistenie,
- modulárne pre protipožiarne a dymotesné dvere,
- s bezpečnostnou poistkou,
- oceleová západka, oceleový držiak západky s dištančnými doštičkami,
- plastová montážna doska.

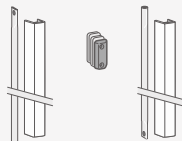

PHX 04 F

- set závary s krytom do výšky dverí až 2270 mm,
- oceleový držiak západky s dištančnými doštičkami.

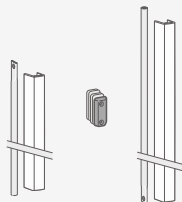

PHX 05 F

- set závary s krytom do výšky dverí až 3400 mm,
- oceleový držiak západky s dištančnými doštičkami pre dvojkriдловé dvere.

Poznámka: Záslepka strelky komponentu 2102 F je súčasťou balenia PHX 04 F a PHX 05 F.

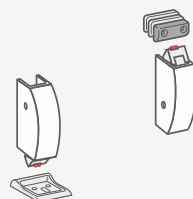

PHX 03 F

- horné a dolné zaistenie s bezpečnostnou poistkou,
- pre protipožiarne a dymotesné dvere,
- oceleová západka,
- oceleový horný držiak západky s dištančnými doštičkami,
- oceleový dolný držiak západky.

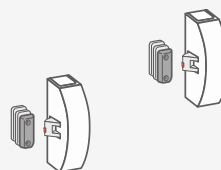

PHX 07 F

- horné a dolné zaistenie s horizontálnou západkou,
- s bezpečnostnou poistkou,
- pre protipožiarne a dymotesné dvere,
- oceleová západka,
- oceleový horný držiak západky s dištančnými doštičkami.



PHA 2105

- paniková tyč 1130 mm,
- pre šírku dverí do 1300 mm.

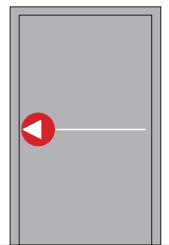

1-bodové
horizontálne
uzamykanie

STM STRIEBORNÁ
MATNÁ

Všetky komponenty
majú striebornú
povrchovú úpravu

SET PHA 2000 JEDNOKRÍDLOVÉ DVERE S JEDNOBODOVÝM ZAIŠTENÍM D1/1B

SET pre šírku dverného krídla do 1300 mm
obsahuje:

- PHA 2102 F - 1-bodové zaistenie
- PHA 2105 - paniková tyč 1130 mm



DK - D1/1B

	Cena za set v €	bez DPH	s DPH
set D1/1B Š-1300		190,90	229,08



DK - KOMPONENTY ZO SETOV

	Cena za kus v €	bez DPH	s DPH
PHA 2105 (1130 mm)		18,90	22,68
PHA 2102 F		172,00	206,40

OVERTE
CENU

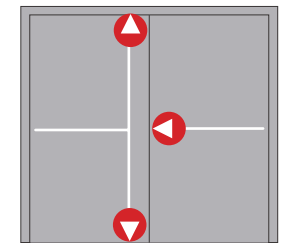

1-bodové horizontálne uzamykanie
2-bodové vertikálne uzamykanie

Je nutné použiť koordinátor zatvárania!

STM STRIEBORNÁ MATNÁ

Všetky komponenty majú striebornú povrchovú úpravu

SET PHA 2000 DVOJKRÍDLOVÉ DVERE S TROJBODOVÝM ZAISTENÍM D2/1H-1D-1B

1. SET pre šírku dverného krídla do 1300 mm s max. výškou 2270 mm obsahuje:

A: Stojace krídlo

- PHA 2102 F - 1-bodové zaistenie
- PHA 2105 - paniková tyč 1130 mm
- PHX 04 F - set závary s krytom pre krídlo dverí s výškou do 2270 mm
- PHX 03 F - horné a dolné zaistenie.

B: Pohyblivé krídlo

- PHA 2102 F - 1-bodové zaistenie
- PHA 2105 - paniková tyč 1130 mm

2. SET pre šírku dverného krídla do 1300 mm s max. výškou 3400 mm obsahuje:

A: Stojace krídlo

- PHA 2102 F - 1-bodové zaistenie
- PHA 2105 - paniková tyč 1130 mm
- PHX 05 F - set závary s krytom pre krídlo dverí s výškou do 3400 mm
- PHX 03 F - horné a dolné zaistenie

B: Pohyblivé krídlo

- PHA 2102 F - 1-bodové zaistenie
- PHA 2105 - paniková tyč 1130 mm

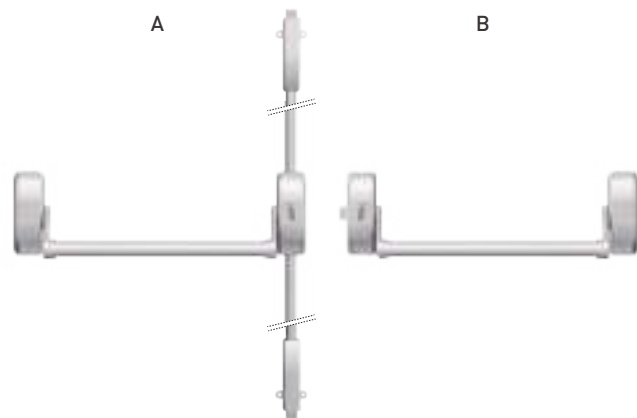

DK - D2/1H-1D-1B

	Cena za set v €	bez DPH	s DPH
1. set D2/1H-1D-1B Š-1300 V-2270		563,90	676,68
2. set D2/1H-1D-1B Š-1300 V-3400		598,50	718,20



DK - KOMPONENTY ZO SETOV

	Cena za kus v €	bez DPH	s DPH
PHA 2105 (1130 mm)		18,90	22,68
PHX 04 F		49,10	58,92
PHX 05 F		83,70	100,44
PHX 03 F		133,00	159,60
PHA 2102 F		172,00	206,40

OVERTE CENU



STM STRIEBORNÁ MATNÁ

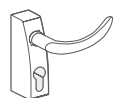
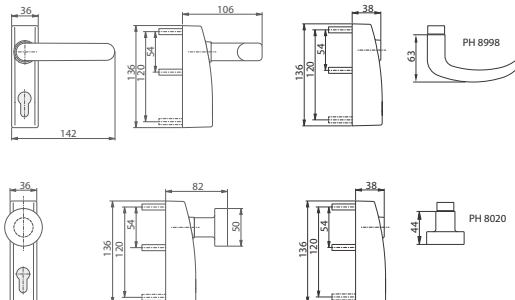

PHT 05 F

- vonkajšie kovanie s kľučkou
- pre protipožiarne a dymotesné dvere
- použitie pre hrúbku krídla dverí do 60 mm
- s integrovaným tesniacim krúžkom
- pripravené pre uchytenie európskej cylindrickej vložky
- so štvorhranom kľučky, s dvoma upevňovacími skrutkami s valcovou hlavou
- s možnosťou uzamykania kľučky



PHT 06

- vonkajšie kovanie s pevnou guľou
- pre štandardné dvere
- použitie pre hrúbku krídla dverí do 60 mm
- pripravené pre uchytenie európskej cylindrickej vložky
- so štvorhranom kľučky, s dvoma upevňovacími skrutkami s valcovou hlavou.

DK - AP1000 S



DK - AP1000 S

- Balenie obsahuje 3 kľúče
- Rozmer: 30 mm
- Možnosť použiť pre produkt PHT 05 a PHT 06

MP - koordinátor zatvárania AZ110



STM STRIEBORNÁ MATNÁ



BIM BIELA MATNÁ



CIM ČIERNA MATNÁ



DK - KOVANIE

	Cena za kus v €	bez DPH	s DPH
kovanie s kľučkou PHT 05 F		92,60	111,12
kovanie s guľou PHT 06		74,90	89,88
DK - AP1000 S jednostranná 30mm		19,10	22,92



MP - KOORDINÁTOR ZATVÁRANIA

	Cena za kus v €	bez DPH	s DPH
koordinátor zatvárania AZ110		52,50	63,00

OVERTE CENU

Odporúčame zakúpiť jednostrannú cylindrickú vložku AP 1000 S 30 mm



PANIKOVÉ
KOVANIA

PHA 1000 a PHB 1000



POUŽITIE A MONTÁŽ PRE PHA 1000

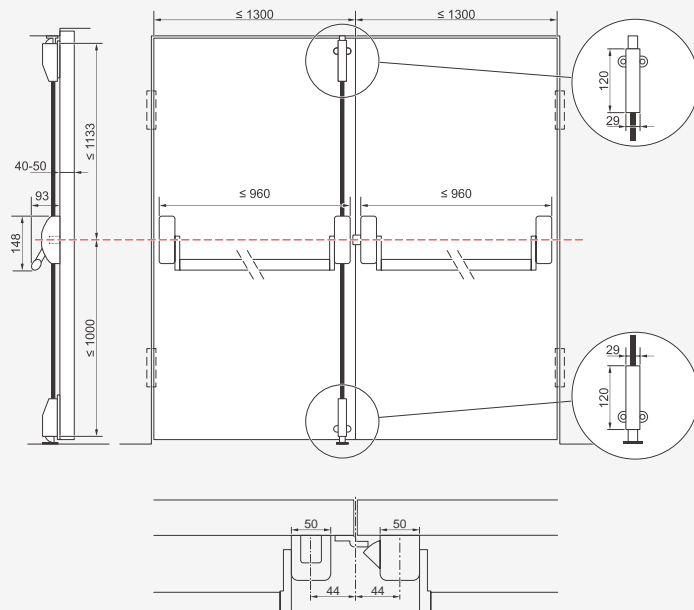

PHA 1000 - horizontálne madlo

- pre jedno a dvojkrídlové dvere na únikových dverách
- certifikované EN 1125 a EN 1634
- pre krídla do šírky 1300 mm a výšky 2500 mm
- maximálna hmotnosť krídla 250 kg

POUŽITIE A MONTÁŽ PRE PHB 1000

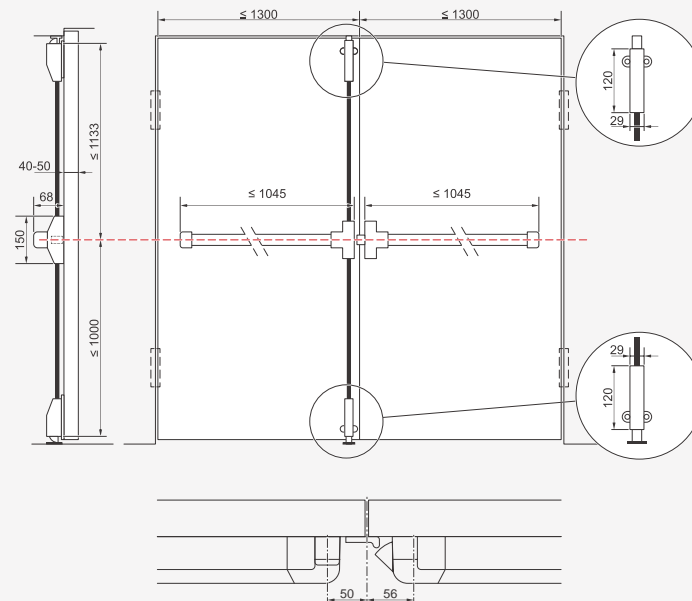

PHB 1000 - tlačná lišta

- pre jedno a dvojkrídlové dvere na únikových dverách
- certifikované EN 1125 a EN 1634
- pre krídla do šírky 1300 mm a výšky 2500 mm
- maximálna hmotnosť krídla 250 kg

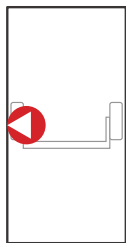

1-bodové
horizontálne
uzamykanie

STM STRIEBORNÁ
MATNÁ

NEM NEREZ
MATNÁ

SET PHA 1000 JEDNOKRÍDLOVÉ DVERE S JEDNOBODOVÝM ZAISTENÍM D1/1B

SET pre šírku dverného krídla do 1300 mm obsahuje:

- PHA 1102 - 1-bodové zaistenie



DK - PHA 1000 - D1/1B - STM

	Cena za set v €	bez DPH	s DPH
set D1/1B Š-1300		96,10	115,32

DK - PHA 1000 - D1/1B - NEM

	Cena za set v €	bez DPH	s DPH
set D1/1B Š-1300		289,40	347,28

OVERTE
CENU

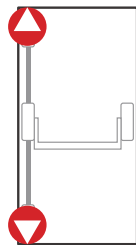

2-bodové
vertikálne
uzamykanie

STM STRIEBORNÁ
MATNÁ

NEM NEREZ
MATNÁ

SET PHA 1000 JEDNOKRÍDLOVÉ DVERE S DVOJBODOVÝM ZAISTENÍM D1/1H-1D

SET pre šírku dverného krídla do 1300 mm
a výšku do 2500 mm obsahuje:

- PHA 1202 - 2-bodové zaistenie

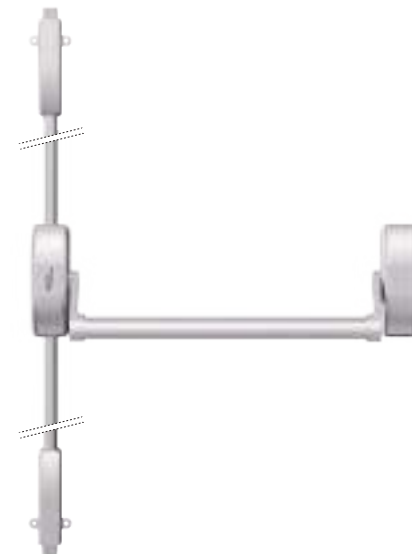

DK - PHA 1000 - D1/1H-1D - STM

	Cena za set v €	bez DPH	s DPH
set D1/1H-1D Š-1300 V-2500		206,00	247,20

DK - PHA 1000 - D1/1H-1D - NEM

	Cena za set v €	bez DPH	s DPH
set D1/1H-1D Š-1300 V-2500		534,50	641,40

OVERTE
CENU

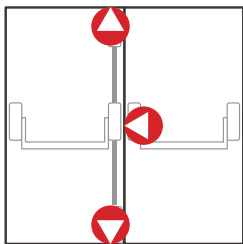

1-bodové horizontálne
uzamykanie
2-bodové vertikálne
uzamykanie

**Je nutné použiť
koordinátor zatvárania!**

STM STRIEBORNÁ
MATNÁ

NEM NEREZ
MATNÁ

SET PHA 1000 DVOJKRÍDLOVÉ DVĚRE S TROJBODOVÝM ZAIŠTENÍM D2/1H-1D-1B

SET pre šírku dverného krídla do 1300 mm
a výšku do 2500 mm obsahuje:

- PHA 1102 - 1-bodové zaistenie
- PHA 1202 - 2-bodové zaistenie

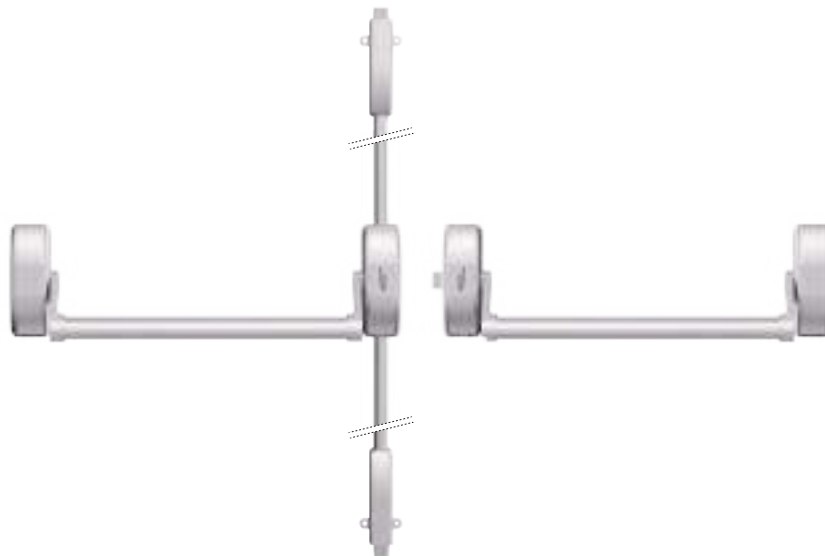

DK - PHA 1000 - D2/1H-1D-1B - STM

	Cena za set v €	bez DPH	s DPH
set D2/1h-1D-1B Š-1300 V-2500		302,10	362,52

DK - PHA 1000 - D2/1H-1D-1B - NEM

	Cena za set v €	bez DPH	s DPH
set D2/1h-1D-1B Š-1300 V-2500		823,90	988,68

OVERTE
CENU

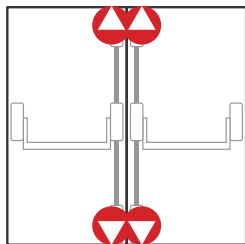

2-bodové vertikálne
uzamykanie
2-bodové vertikálne
uzamykanie

**Je nutné použiť
koordinátor zatvárania!**

STM STRIEBORNÁ
MATNÁ

NEM NEREZ
MATNÁ

SET PHA 1000 DVOJKRÍDLOVÉ DVERE SO ŠTVORBODOVÝM ZAIŠTENÍM D2/2H-2D

SET pre šírku dverného krídla do 1300 mm
a výšku do 2500 mm obsahuje:

- PHA 1202 - 2-bodové zaistenie
- PHA 1202 - 2-bodové zaistenie

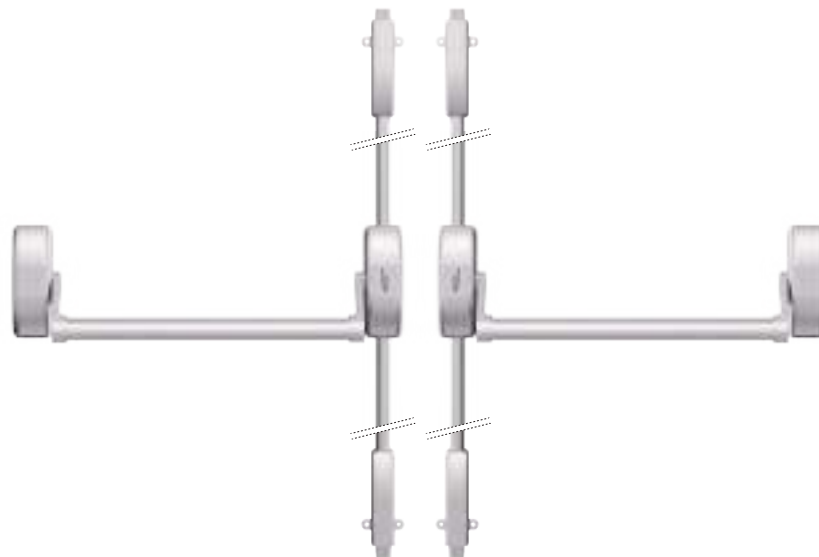

DK - PHA 1000 - D2/2H-2D - STM

	Cena za set v €	bez DPH	s DPH
set D2/2H-2D Š-1300 V-2500		412,00	494,40

DK - PHA 1000 - D2/2H-2D - NEM

	Cena za set v €	bez DPH	s DPH
set D2/2H-2D Š-1300 V-2500		1 069,10	1 282,92

OVERTE
CENU

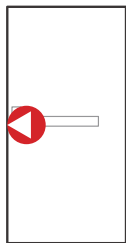

1-bodové
horizontálne
uzamykanie

STM STRIEBORNÁ
MATNÁ

NEM NEREZ
MATNÁ

SET PHB 1000 JEDNOKRÍDLOVÉ DVERE S JEDNOBODOVÝM ZAISTENÍM D1/1B

SET pre šírku dverného krídla do 1300 mm obsahuje:

- PHB 1102 - 1-bodové zaistenie



DK - PHB 1000 - D1/1B - STM

	Cena za set v €	bez DPH	s DPH
set D1/1B Š-1300		171,60	205,92

DK - PHB 1000 - D1/1B - NEM

	Cena za set v €	bez DPH	s DPH
set D1/1B Š-1300		533,30	639,96

OVERTE
CENU

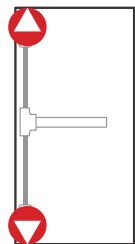

2-bodové
vertikálne
uzamykanie

STM STRIEBORNÁ
MATNÁ

NEM NEREZ
MATNÁ

SET PHB 1000 JEDNOKRÍDLOVÉ DVERE S DVOJBODOVÝM ZAISTENÍM D1/1H-1D

SET pre šírku dverného krídla do 1300 mm
a výšku do 2500 mm obsahuje:

- PHB 1202 - 2-bodové zaistenie



DK - PHB 1000 - D1/1H-1D - STM

	Cena za set v €	bez DPH	s DPH
set D1/1H-1D Š-1300 V-2500		277,00	332,40

DK - PHB 1000 - D1/1H-1D - NEM

	Cena za set v €	bez DPH	s DPH
set D1/1H-1D Š-1300 V-2500		771,30	925,56

OVERTE
CENU

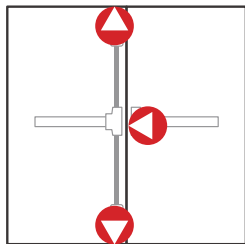

1 bod horizontálne
uzamykanie
2 body vertikálne
uzamykanie

**Je nutné použiť
koordinátor zatvárania!**

STM STRIEBORNÁ
MATNÁ

NEM NEREZ
MATNÁ

SET PHB 1000 DVOJKRÍDLOVÉ DVERE S TROJBODOVÝM ZAIŠTENÍM D2/1H-1D-1B

SET pre šírku dverného krídla do 1300 mm
a výšku do 2500 mm obsahuje:

- PHB 1102 - 1-bodové zaistenie
- PHB 1202 - 2-bodové zaistenie



DK - PHB 1000 - D2/1H-1D-1B - STM

	Cena za set v €	bez DPH	s DPH
set D2/1h-1D-1B Š-1300 V-2500		448,60	538,32

DK - PHB 1000 - D2/1H-1D-1B - NEM

	Cena za set v €	bez DPH	s DPH
set D2/1h-1D-1B Š-1300 V-2500		1 304,60	1 565,52

OVERTE
CENU

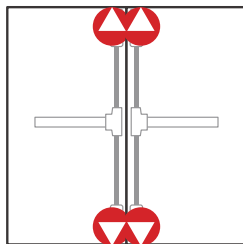

2 body vertikálne
uzamykanie
2 body vertikálne
uzamykanie

**Je nutné použiť
koordinátor zatvárania!**

STM STRIEBORNÁ
MATNÁ

NEM NEREZ
MATNÁ

SET PHB 1000 DVOJKRÍDLOVÉ DVERE SO ŠTVORBODOVÝM ZAIŠTENÍM D2/2H-2D

SET pre šírku dverného krídla do 1300 mm
a výšku do 2500 mm obsahuje:

- PHB 1202 - 2-bodové zaistenie
- PHB 1202 - 2-bodové zaistenie

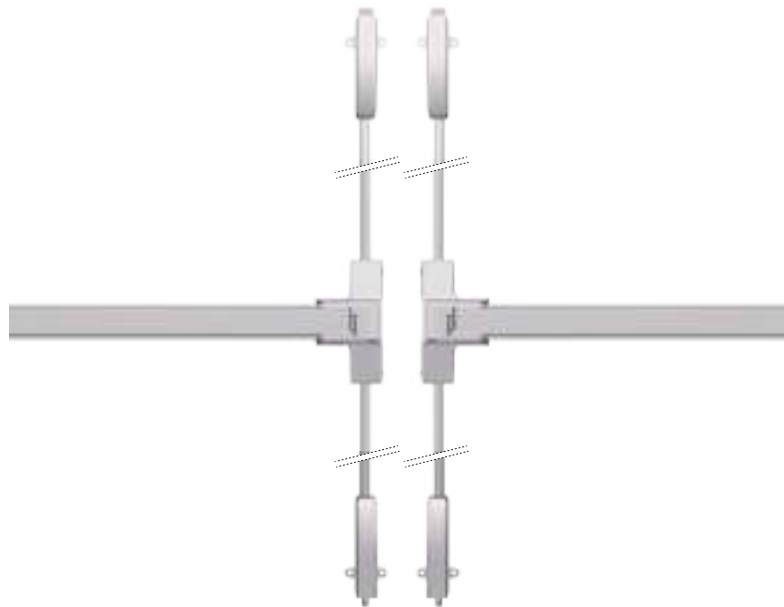

DK - PHB 1000 - D2/2H-2D - STM

	Cena za set v €	bez DPH	s DPH
set D2/2H-2D Š-1300 V-2500		554,00	664,80

DK - PHB 1000 - D2/2H-2D - NEM

	Cena za set v €	bez DPH	s DPH
set D2/2H-2D Š-1300 V-2500	1 542,70		1 851,24

OVERTE
CENU



STM STRIEBORNÁ
MATNÁ

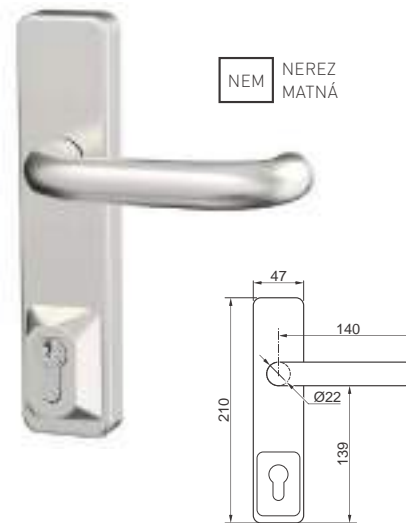

NEM NEREZ
MATNÁ

i Cylindrická vložka nie je súčasťou kovania

i Cylindrická vložka nie je súčasťou kovania



DK - KOVANIE PHT 10 - SHK STM

	Cena za kus v €	bez DPH	s DPH
kovanie s kľučkou PHT 10		93,20	111,84

DK - KOVANIE PHT 10 - SHK NEM

	Cena za kus v €	bez DPH	s DPH
kovanie s kľučkou PHT 10		150,70	180,84

OVERTE
CENU



DOPLNKY

OKOPOVÉ PLECHY, VETRACIE
MRIEŽKY, PRIEZORNÍKY, ČÍSLICE





VYSVETLIVKY



montáž skrutkovaním
samorezka/metrický závit



samolepiaci



OVERTE
CENU

MP - OKOPOVÝ PLECH - FÓLIOVANÝ, SAMOLEPIACI - KUS

	Výška plechu v mm	MJ	Šírka dverí									
			600 mm		700 mm		800 mm		900 mm		1000mm	
			Cena v €	bez DPH	s DPH	bez DPH	s DPH	bez DPH	s DPH	bez DPH	s DPH	bez DPH
MP okopový plech na dvere - F1	100	ks	6,72	8,06	7,85	9,42	9,00	10,80	10,10	12,12	11,20	13,44
hrúbka plechu 0,8 mm	150	ks	10,10	12,12	11,80	14,16	13,45	16,14	15,15	18,18	16,80	20,16
	200	ks	13,45	16,14	15,70	18,84	17,95	21,54	20,20	24,24	22,40	26,88
	250	ks	16,80	20,16	19,60	23,52	22,40	26,88	25,20	30,24	28,00	33,60
	300	ks	20,20	24,24	23,55	28,26	26,90	32,28	30,25	36,30	33,60	40,32
STM STRIEBORNÁ MATNÁ	400	ks	26,90	32,28	31,40	37,68	35,85	43,02	40,35	48,42	44,80	53,76
	500	ks	33,60	40,32	39,20	47,04	44,80	53,76	50,40	60,48	56,00	67,20

Orientačná cena za 1 cm² - 0,0112 € bez DPH

MP okopový plech na dvere - F9	100	ks	6,25	7,50	7,30	8,76	8,35	10,02	9,40	11,28	10,40	12,48
hrúbka plechu 0,8 mm	150	ks	9,40	11,28	10,95	13,14	12,50	15,00	14,05	16,86	15,60	18,72
	200	ks	12,50	15,00	14,60	17,52	16,65	19,98	18,75	22,50	20,80	24,96
	250	ks	15,60	18,72	18,20	21,84	20,80	24,96	23,40	28,08	26,00	31,20
	300	ks	18,75	22,50	21,85	26,22	25,00	30,00	28,10	33,72	31,20	37,44
NEM NEREZ MATNÁ	400	ks	25,00	30,00	29,15	34,98	33,30	39,96	37,45	44,94	41,60	49,92
	500	ks	31,20	37,44	36,40	43,68	41,60	49,92	46,80	56,16	52,00	62,40

Orientačná cena za 1 cm² - 0,0104 € bez DPH



RAL FARBY

Viac produktov a povrchov
na mp-kovania.sk

- Šírka okopového plechu je v tabuľke uvedená podľa základných rozmerov dverí. Pri objednávke je nutné uviesť presný rozmer dverí.
- Okopový plech vyrábame o 5 mm kratší ako je šírka samotného krídla dverí.
- Pri falcovaných dverách je dôležité uviesť šírku dverného krídla oboch strán.
- Okopové plechy sú samolepiace, preto je dôležité pred lepením dverné krídlo dôkladne odmastniť a očistiť od prachu.





BIM BIELA MATNÁ



SIM SIVÁ MATNÁ



BEM BÉŽOVÁ MATNÁ



HNM.
S HNEDÁ MATNÁ SVETLÁ



HNM.
T HNEDÁ MATNÁ TMAVÁ



ANM ANTRACIT MATNÝ



CIM ČIERNA MATNÁ

MATERIÁL: PLAST

Rozmery v mm

celkový rozmer
mriežky
450 x 134

montážny otvor pre
osadenie vetracej mriežky
438 x 123

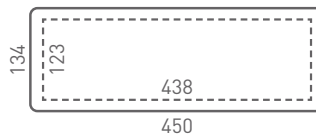

ZPT - VETRACIA MRIEŽKA PLASTOVÁ

	Cena za kus v €	bez DPH	s DPH
BIM - Biela matná		9,90	11,88
SIM - Sivá matná		9,90	11,88
BEM - Béžová matná		9,90	11,88
HNM.S - Hnedá matná svetlá		9,90	11,88
HNM.T - Hnedá matná tmavá		9,90	11,88
ANM - Antracit matný		9,90	11,88
CIM - Čierna matná		9,90	11,88

**OVERTE
CENU**





MP - VETRACIA MRIEŽKA HLINÍKOVÁ

OVERTE
CENU

	Výška plechu v mm	MJ	Dĺžka											
			250 mm		400 mm		500 mm		600 mm		800 mm		1000mm	
			bez DPH	s DPH	bez DPH	s DPH	bez DPH	s DPH	bez DPH	s DPH	bez DPH	s DPH	bez DPH	s DPH
MP - vetracia mriežka hliníková	60	ks	6,10	7,32	7,30	8,76	8,70	10,44	8,75	10,50	14,20	17,04	13,60	16,32
	80	ks	-	-	7,80	9,36	8,40	10,08	9,60	11,52	14,05	16,86	15,40	18,48
	100	ks	-	-	8,80	10,56	10,20	12,24	10,90	13,08	14,90	17,88	18,70	22,44



STM STRIEBORNÁ MATNÁ



SRL - VETRACIA MRIEŽKA HLINÍKOVÁ

MATERIÁL: HLINÍK

OVERTE
CENU

	Výška plechu v mm	MJ	Dĺžka													
			250 mm		400 mm		500 mm		600 mm		800 mm		1000mm		2000mm	
			bez DPH	s DPH	bez DPH	s DPH	bez DPH	s DPH	bez DPH	s DPH	bez DPH	s DPH	bez DPH	s DPH	bez DPH	s DPH
SRL - Alfa - vetracia mriežka hliníková	60	ks	10,00	12,00	10,50	12,60	12,00	14,40	13,00	15,60	17,50	21,00	20,00	24,00	34,00	40,80
	80	ks	11,00	13,20	12,00	14,40	14,00	16,80	15,50	18,60	19,50	23,40	24,00	28,80	43,00	51,60
	100	ks	11,50	13,80	13,00	15,60	15,50	18,60	16,50	19,80	22,50	27,00	27,00	32,40	47,50	57,00
	130	ks	14,50	17,40	15,50	18,60	16,50	19,80	19,00	22,80	26,50	31,80	30,50	36,60	57,50	69,00
	150	ks	15,50	18,60	17,50	21,00	20,00	24,00	22,00	26,40	31,00	37,20	36,00	43,20	73,00	87,60

SRL - Alfa - vetracia mriežka hliníková	60	ks	9,50	11,40	10,50	12,60	12,00	14,40	12,50	15,00	17,00	20,40	18,50	22,20	32,50	39,00
	80	ks	10,50	12,60	11,50	13,80	13,50	16,20	15,00	18,00	19,00	22,80	22,00	26,40	38,50	46,20
	100	ks	11,00	13,20	13,00	15,60	15,50	18,60	16,00	19,20	21,00	25,20	24,50	29,40	44,50	53,40
	130	ks	12,00	14,40	15,00	18,00	17,00	20,40	18,00	21,60	24,50	29,40	28,50	34,20	52,50	63,00
	150	ks	13,00	15,60	17,00	20,40	19,50	23,40	21,50	25,80	30,50	36,60	35,00	42,00	67,00	80,40



STM STRIEBORNÁ
MATNÁ (C0)



OVERTE
CENU

	Výška plechu v mm	MJ	250 mm		400 mm		500 mm		600 mm		800 mm		1000mm		2000mm	
		Cena v €	bez DPH	s DPH	bez DPH	s DPH	bez DPH	s DPH	bez DPH	s DPH	bez DPH	s DPH	bez DPH	s DPH	bez DPH	s DPH
SRL - Alfa - vetracia mriežka hliníková 	60	ks	11,50	13,80	13,50	16,20	15,00	18,00	15,50	18,60	21,00	25,20	23,00	27,60	40,50	48,60
	80	ks	12,50	15,00	15,00	18,00	16,50	19,80	18,00	21,60	23,50	28,20	26,50	31,80	48,00	57,60
	100	ks	13,00	15,60	16,00	19,20	18,50	22,20	20,00	24,00	26,00	31,20	30,50	36,60	55,50	66,60
	130	ks	16,50	19,80	18,50	22,20	21,00	25,20	22,50	27,00	31,00	37,20	37,00	44,40	69,00	82,80
	150	ks	17,50	21,00	21,00	25,20	23,50	28,20	26,50	31,80	37,00	44,40	43,00	51,60	83,00	99,60

NEM NEREZ MATNÁ

SRL - Alfa - vetracia mriežka hliníková 	60	ks	10,00	12,00	11,50	13,80	13,00	15,60	13,50	16,20	17,50	21,00	19,50	23,40	34,50	41,40
	80	ks	11,00	13,20	12,00	14,40	14,00	16,80	15,50	18,60	20,00	24,00	23,00	27,60	41,50	49,80
	100	ks	11,50	13,80	13,50	16,20	15,50	18,60	17,00	20,40	22,50	27,00	26,00	31,20	47,50	57,00
	130	ks	14,50	17,40	16,00	19,20	18,00	21,60	19,00	22,80	26,00	31,20	30,00	36,00	56,50	67,80
	150	ks	15,50	18,60	17,50	21,00	21,00	25,20	23,00	27,60	32,50	39,00	37,50	45,00	72,50	87,00

ZLM ZLATÁ MATNÁ
(C4)

SRL - Alfa - vetracia mriežka hliníková 	60	ks	10,50	12,60	12,50	15,00	13,50	16,20	14,00	16,80	19,00	22,80	21,00	25,20	37,00	44,40
	80	ks	11,50	13,80	13,50	16,20	15,00	18,00	16,50	19,80	21,00	25,20	24,00	28,80	43,50	52,20
	100	ks	12,00	14,40	14,50	17,40	16,50	19,80	18,00	21,60	24,00	28,80	27,50	33,00	50,50	60,60
	130	ks	15,00	18,00	17,00	20,40	19,00	22,80	20,50	24,60	28,50	34,20	33,50	40,20	62,50	75,00
	150	ks	16,00	19,20	19,00	22,80	21,50	25,80	24,00	28,80	33,50	40,20	39,00	46,80	75,50	90,60

BRM BRONZ MATNÝ
(C33)

SRL - Alfa - vetracia mriežka hliníková 	60	ks	11,50	13,80	13,50	16,20	15,00	18,00	15,50	18,60	21,00	25,20	23,00	27,60	40,50	48,60
	80	ks	12,50	15,00	15,00	18,00	16,50	19,80	18,00	21,60	23,50	28,20	26,50	31,80	48,00	57,60
	100	ks	13,00	15,60	16,00	19,20	18,50	22,20	20,00	24,00	26,00	31,20	30,50	36,60	55,50	66,60
	130	ks	16,50	19,80	18,50	22,20	21,00	25,20	22,50	27,00	31,00	37,20	37,00	44,40	69,00	82,80
	150	ks	17,50	21,00	21,00	25,20	23,50	28,20	26,50	31,80	37,00	44,40	43,00	51,60	83,00	99,60

CIM ČIERNÁ MATNÁ
(C35)

MP - priezorník s krytkou



CHL CHRÓM LESKLÝ



NIM. LL NIKEL MATNÝ



ZLL ZLATÁ LESKLÁ



BRM BRONZ MATNÝ



CIM ČIERNA MATNÝ



MP predĺženie na priezorník o 1 cm

MP - priezorník set



CHL CHRÓM LESKLÝ



NIM. LL NIKEL MATNÝ



ZLL ZLATÁ LESKLÁ



BRM BRONZ MATNÝ



CIM ČIERNA MATNÝ

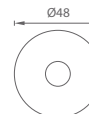

MATERIÁL: ZAMAK



MP - PRIEZORNÍK S KRYTKOU	CIM, CHL, NIM		BRM, ZLL	
	Cena v €		Cena v €	
	bez DPH	s DPH	bez DPH	s DPH
Priezorník s krytkou set	3,60	4,32	8,00	9,60
Predĺženie na priezorník o 1 cm kus	1,50	1,80	-	-

MP - PRIEZORNÍK SET	CIM, CHL, NIM		BRM, ZLL	
	Cena v €		Cena v €	
	bez DPH	s DPH	bez DPH	s DPH
Priezorník s krytkou a podložkou set	6,00	7,20	12,00	14,40
Predĺženie na priezorník o 1 cm kus	1,50	1,80	-	-

OVERTE
CENU

BETA 2



NEM NEREZ MATNÁ (F6)



CIM ČIERNA MATNÁ (F8)

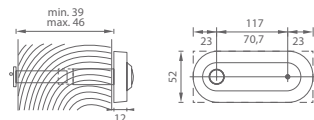

Otvor pre priezorník: Ø14 mm
Možnosť predĺženia priezorníka o 10 mm - str. 448

ATLAS 2 / OMEGA 2



NEM NEREZ MATNÁ (F6)



CIM ČIERNA MATNÁ (F8)

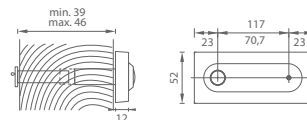

Otvor pre priezorník: Ø14 mm
Možnosť predĺženia priezorníka o 10 mm - str. 448

**AXA - MENOVKA S PRIEZORNÍKOM BETA 2**

	Cena za set v €	bez DPH	s DPH
menovka s priezorníkom Beta 2 - NEM		27,50	33,00
menovka s priezorníkom Beta 2 - CIM		30,20	36,24

AXA - MENOVKA S PRIEZORNÍKOM ATLAS 2/OMEGA 2

	Cena za set v €	bez DPH	s DPH
menovka s priezorníkom Atlas 2 - NEM		27,50	33,00
menovka s priezorníkom Omega 2 - CIM		30,20	36,24

OVERTE
CENU

0123456789

CIM ČIERNA MATNÁ

MATERIÁL: ZAMAK

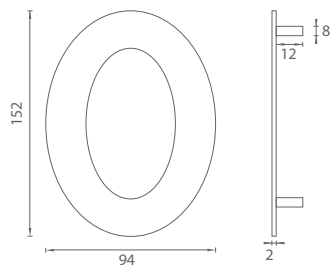

SS - ČÍSLICA 152 SO SKRUTKAMI

	Cena za kus v €	bez DPH	s DPH
číslica 152		11,50	13,80



OVERTE
CENU

218

0 1 2 3 4

5 6 7 8 9

NEM NEREZ MATNÁ

MATERIÁL: NEREZ

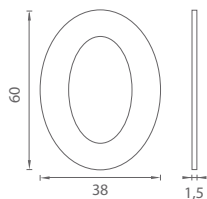

0 1 2 3 4

5 6 7 8 9

a b c d

NEM NEREZ MATNÁ

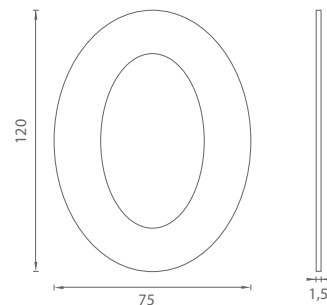

i Výška písmen **a, c** je 60 mm
Výška písmen **b, d** je 100 mm



LR - ČÍSLICA A PÍSMENO 60 NALEPOVACIE

	Cena za kus v €	bez DPH	s DPH
číslica 60		11,30	13,56



LR - ČÍSLICA A PÍSMENO 120 NALEPOVACIE

	Cena za kus v €	bez DPH	s DPH
číslica 120		13,80	16,56
písmeno		13,80	16,56



OVERTE
CENU

0 1 2 3 4
5 6 7 8 9
a b c d

NEM NEREZ MATNÁ

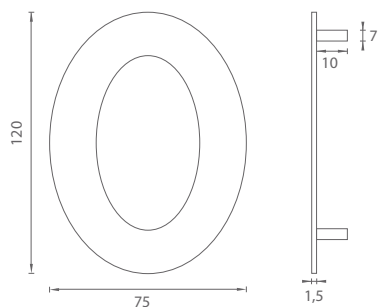

i Výška písmen **a, c** je 60 mm
Výška písmen **b, d** je 100 mm



LR - ČÍSLICA A PÍSMENO 120 SO SKRUTKAMI

	Cena za kus v €	bez DPH	s DPH
číslica 120		15,50	18,60
písmeno		15,50	18,60



OVERTE
CENU

MATERIÁL: NEREZ











A close-up photograph of a person's hand holding a key with a black strap. The hand is positioned near a silver door handle on a grey door. The lighting is soft, and the background is slightly blurred.

DOPLNKY







CYLINDRICKÉ
VLOŽKY
A UZAMYKACIE
SYSTÉMY

VYSVETLIVKY



BEZPEČNOSTNÉ PRVKY

-  **VP** voľný profil – výroba kópií kľúčov vo všetkých kľúčových službách
-  **LP** licenčný profil – výroba kópií kľúčov u všetkých licenčných partnerov spoločnosti **dormakaba** na Slovensku (napr. MP KOVANIA s.r.o.) výhradne po predložení bezp. karty
-  **MP** MP profil - výroba kópií v spoločnosti MP KOVANIA s.r.o., MP UZAMYKACIE SYSTÉMY s.r.o., (www.mp-kluce.sk) výhradne po predložení bezpečnostnej karty
-  **dormakaba** profil - výroba kópií kľúčov len v spoločnosti **dormakaba** v Rakúsku, výhradne po predložení bezpečnostnej karty
-  **b.t.3** bezpečnostná trieda 3
-  **b.t.3 NBU** bezpečnostná trieda 3 podľa **NBU**
-  **b.t.4 NBU** bezpečnostná trieda 4 podľa **NBU**
-  odolná proti SG metóde – vložka má patentovú ochranu proti odomknutiu touto nedeštruktívnou dynamickou metódou, nazývanou tiež „Bumping“ metóda.
-  odolná proti vyhmataniu – vložka má zvýšenú ochranu proti odomknutiu za pomoci šperhákov a planžiet.
-  odolná proti odvrtaniu v telese a bubienku, použitím špeciálnych prvkov z tvrdeného ocele
-  prekrytý profil zabraňuje prístupu plochým predmetom

ŠTANDARDNÉ PRVKY

-  **EF** vhodné na protipožiarnu dvere
-  **LONG LIFE** Long life – prevedenie z vysokokvalitných materiálov zaručujúcich dlhodobú životnosť
-  **5** 5 rokov záruka
-  **3** počet kľúčov ku vložke v balení 3 ks
-  **5** počet kľúčov ku vložke v balení 5 ks
-  **2** počet kľúčov k visiacemu zámku v balení 2 kľúče
-  určená výhradne pre uzamykacie systémy

PRÍPLATKOVÉ PRVKY

-  **BSZ** BSZ - odomykanie pri zasunutom a pootočenom kľúči na opačnej strane
-  možnosť zjednotenia viacerých vložiek na spoločný kľúč
-  **10z** možnosť dodania vložky s ozubeným kolieskom (10 zubov)
-  **18z** možnosť dodania vložky s ozubeným kolieskom (18 zubov)
-  **SAT** zvolenie dočasného prístupu
-  **TIC** cylindrická vložka s tepelným mostom
-  **BAZ** cylindrická vložka s možnosťou prekódovania (jamkové kľúče)
-  **SUZ** cylindrická vložka s možnosťou prekódovania (PEXTRA plus)
-  **SSW** cylindrická vložka odolná proti prachu a striekajúcej vode
-  **SBS** ochrana proti rozlomeniu vložky (na vonkajšiu stranu vložky)
-  **LAM** cylindrická vložka odolná voči rozlomeniu
-  **FZG** vložka s voľnoběžným palcom pre zámky s prevodom a panikovou funkciou



NIM NIKEL MATNÝ



NIM NIKEL MATNÝ



ZLL ZLATÁ LESKLÁ



ZLL ZLATÁ LESKLÁ



CIM ČIERNA MATNÁ

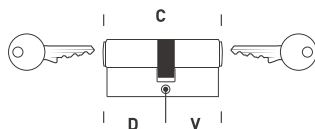

CIM ČIERNA MATNÁ

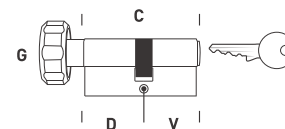

OVERTE
CENU

MP - STAVEBNÁ CYLINDRICKÁ VLOŽKA

	Cena za kus v €	bez DPH	s DPH
vložka AL 30/30 NIM		5,50	6,60
vložka 30/40 ZLL		10,00	12,00
vložka AL 30/30 CIM		5,50	6,60
vložka AL 30/35 CIM		6,00	7,20
vložka AL 30/45 NIM		7,00	8,40
vložka AL 30/45 CIM		7,00	8,40
vložka AL 40/40 NIM		7,50	9,00
vložka AL 40/45 NIM		8,00	9,60

MP - STAVEBNÁ CYLINDRICKÁ VLOŽKA S GOMBÍKOM

	Cena za set v €	bez DPH	s DPH
vložka s gombíkom AL 30/30G NIM		7,00	8,40
vložka s gombíkom AL 30/30G CIM		7,00	8,40
vložka s gombíkom AL 30/35G CIM		7,50	9,00
vložka s gombíkom 30/35G ZLL		11,50	13,80
vložka s gombíkom 30/40G ZLL		12,00	14,40
vložka s gombíkom AL 30/45G CIM		8,50	10,20
vložka s gombíkom AL 30/45G NIM		8,50	10,20



NIM NIKEL MATNÝ

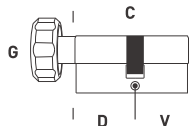

CIM ČIERNA MATNÁ

**MP - CYLINDRICKÁ VLOŽKA WC S GOMBÍKOM**

	Cena za kus v €	bez DPH	s DPH
vložka WC s gombíkom 26/17G NIM		10,10	12,12
vložka WC s gombíkom 26/17G CIM		10,10	12,12
vložka WC s gombíkom 17/26G NIM		10,10	12,12
vložka WC s gombíkom 17/26G CIM		10,10	12,12

**OVERTE
CENU**

základná vložka **AP1000 S**

Precízne spracovanie a kvalitné materiály zaručujú dlhú životnosť a funkčnosť cylindrickej vložky.

vložka **SAMOSTATNÁ**

AP1000 S

obojstranná vložka



dormakaba

- základná samostatná vložka bez prídavných bezpečnostných prvkov
- VP - voľný profil – kópiu kľúča vyrobia v ktorejkoľvek kľúčovej službe
- súčasťou vložky sú 3 kľúče
- BSZ funkcia - odomykanie pri zasunutom a pootočenom kľúči na opačnej strane je za príplatok
- možnosť zjednotenia viacerých vložiek na spoločný kľúč za príplatok
- 5-ročná záruka
- vhodná do protipožiarnych dverí

— - bezpečnostné prvky

— - štandardné prvky

— - príplatkové prvky

Cena bez DPH
od **19€**

Cena s DPH od **23€**



OVERTE
CENU A
DOSTUPNOSŤ

DK - SAMOSTATNÁ CYLINDRICKÁ VLOŽKA

AP1000 S

OBOJSTRANNÁ VLOŽKA	rozmer D+V v mm	rozmer C v mm	v € bez DPH	s DPH
AP1000 S	27,5 + 27,5	55	18,50	22,20
AP1000 S	30 + 30	60	18,50	22,20
AP1000 S	27,5 + 35,5	63	19,60	23,52
AP1000 S	30 + 35,5	65,5	19,60	23,52
AP1000 S	27,5 + 40	67,5	21,90	26,28
AP1000 S	30 + 40	70	21,90	26,28
AP1000 S	35,5 + 35,5	71	21,90	26,28
AP1000 S	27,5 + 45	72,5	24,30	29,16
AP1000 S	30 + 45	75	24,30	29,16
AP1000 S	35,5 + 40	75,5	24,30	29,16
AP1000 S	30 + 50	80	26,60	31,92
AP1000 S	40 + 40	80	26,60	31,92
AP1000 S	35,5 + 45	80,5	26,60	31,92
AP1000 S	30 + 55	85	28,90	34,68
AP1000 S	40 + 45	85	28,90	34,68
AP1000 S	35,5 + 50	85,5	28,90	34,68
AP1000 S	30 + 60	90	32,50	39,00
AP1000 S	40 + 50	90	32,50	39,00
AP1000 S	45 + 45	90	32,50	39,00
AP1000 S	35,5 + 55	90,5	32,50	39,00
AP1000 S	45 + 50	95	36,10	43,32
AP1000 S	40 + 55	95	36,10	43,32
AP1000 S	30 + 65	95	36,10	43,32
AP1000 S	35,5 + 60	95,5	36,10	43,32
AP1000 S	40 + 60	100	39,60	47,52
AP1000 S	45 + 55	100	39,60	47,52
AP1000 S	30 + 70	100	39,60	47,52
AP1000 S	50 + 50	100	39,60	47,52
AP1000 S	35,5 + 65	100,5	39,60	47,52
AP1000 S	45 + 60	105	43,20	51,84

OBOJSTRANNÁ VLOŽKA	rozmer D+V v mm	rozmer C v mm	v € bez DPH	s DPH
AP1000 S	30 + 75	105	43,20	51,84
AP1000 S	50 + 60	110	46,80	56,16
AP1000 S	55 + 55	110	46,80	56,16
Príplatok za 5 mm navych			8,50	10,20

NADŠTANDARDNÉ PREVEDENIA	Označenie	v € bez DPH	s DPH
Núdzová funkcia	BSZ	21,00	25,20
Zjednotenie vložiek	SK	10,00	12,00
Ozubené koliesko s 10 zubami	ZR10	10,10	12,12
Ozubené koliesko s 18 zubami	ZR18	14,10	16,92
Zastepovací inzert	BL	7,80	9,36
Prevedenie zlatá matná	ZLM	5,00	6,00
Prevedenie zlatá lesklá	ZLL	18,00	21,60
Prevedenie čierna matná	CIM	19,50	23,40
Vlastný kľúč VK-AP1000 S		3,50	4,20

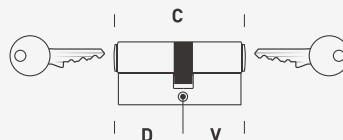

bezpečnostná vložka **EAP2pro S**

Precízne spracovanie a kvalitné materiály zaručujú dlhú životnosť a funkčnosť cylindrickej vložky.

bezpečnostná vložka **SAMOSTATNÁ**

EAP2pro S

obojstranná vložka

STN EN 1627 - b.t. 3

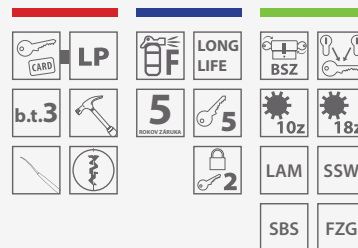

dormakaba

- samostatná bezpečnostná vložka, bez ochrany proti odvráteniu
- bezpečnostná trieda b.t. 3 s prekrytým profilom
- súčasťou vložky je 5 kľúčov + bezpečnostná karta
- LP - licenčný profil – výroba kópií kľúčov u všetkých licenčných partnerov spoločnosti dormakaba na Slovensku, výhradne po predložení bezp. karty
- BSZ funkcia - odomykanie pri zasunutom a pootočenom kľúči na opačnej strane je za príplatok
- možnosť zjednotenia viacerých vložiek na spoločný kľúč za príplatok
- odolná proti planžetovaniu a „bumping“ metóde
- možnosť kombinovať s vložkou AP2pro S
- 5-ročná záruka
- vhodná do protipožiarnych dverí

Cena bez DPH
od **30€**

Cena s DPH od **36€**



OVERTE
CENU A
DOSTUPNOSŤ

- bezpečnostné prvky

- štandardné prvky

- príplatkové prvky

DK - SAMOSTATNÁ CYLINDRICKÁ VLOŽKA

EAP2pro S

OBOJSTRANNÁ VLOŽKA	rozmer D+V v mm	rozmer C v mm	v € bez DPH	s DPH
EAP2pro S	23,5 + 23,5	47	29,70	35,64
EAP2pro S	23,5 + 30	53,5	29,70	35,64
EAP2pro S	27,5 + 27,5	55	29,70	35,64
EAP2pro S	23,5 + 35,5	59	29,70	35,64
EAP2pro S	30 + 30	60	29,70	35,64
EAP2pro S	27,5 + 35,5	63	30,10	36,12
EAP2pro S	23,5 + 40	63,5	30,10	36,12
EAP2pro S	30 + 35,5	65,5	30,10	36,12
EAP2pro S	27,5 + 40	67,5	30,50	36,60
EAP2pro S	30 + 40	70	30,50	36,60
EAP2pro S	35,5 + 35,5	71	30,50	36,60
EAP2pro S	27,5 + 45	72,5	33,70	40,44
EAP2pro S	30 + 45	75	33,70	40,44
EAP2pro S	35,5 + 40	75,5	33,70	40,44
EAP2pro S	30 + 50	80	36,90	44,28
EAP2pro S	40 + 40	80	36,90	44,28
EAP2pro S	35,5 + 45	80,5	36,90	44,28
EAP2pro S	30 + 55	85	40,20	48,24
EAP2pro S	40 + 45	85	40,20	48,24
EAP2pro S	35,5 + 50	85,5	40,20	48,24
EAP2pro S	30 + 60	90	45,10	54,12
EAP2pro S	40 + 50	90	45,10	54,12
EAP2pro S	45 + 45	90	45,10	54,12
EAP2pro S	35,5 + 55	90,5	45,10	54,12
EAP2pro S	45 + 50	95	50,10	60,12
EAP2pro S	40 + 55	95	50,10	60,12
EAP2pro S	30 + 65	95	50,10	60,12
EAP2pro S	35,5 + 60	95,5	50,10	60,12
EAP2pro S	40 + 60	100	55,10	66,12
EAP2pro S	45 + 55	100	55,10	66,12

OBOJSTRANNÁ VLOŽKA	rozmer D+V v mm	rozmer C v mm	v € bez DPH	s DPH
EAP2pro S	30 + 70	100	55,10	66,12
EAP2pro S	50 + 50	100	55,10	66,12
EAP2pro S	35,5 + 65	100,5	55,10	66,12
EAP2pro S	45 + 60	105	60,10	72,12
EAP2pro S	30 + 75	105	60,10	72,12
EAP2pro S	50 + 60	110	65,10	78,12
EAP2pro S	55 + 55	110	65,10	78,12
Príplatok za 5 mm navyš			8,50	10,20

NADŠTANDARDNÉ PŘEVEDENIA	Označenie	v € bez DPH	s DPH
Núdzová funkcia	BSZ	21,00	25,20
Zjednotenie vložiek	SK	10,00	12,00
Vložka s voľnobežným palcom	FZG	22,70	27,24
Ozubené koliesko s 10 zubami	ZR10	10,10	12,12
Ozubené koliesko s 18 zubami	ZR18	14,10	16,92
Vložka s oceľovou výstuhou	LAM	33,00	39,60
Ochrana proti prachu a vode	SSW	83,60	100,32
Ochrana proti rozlomeniu vložky	SBS	9,80	11,76
Zastepovací inžert	BL	7,80	9,36
Prevedenie zlatá matná	ZLM	5,00	6,00
Prevedenie zlatá lesklá	ZLL	18,00	21,60
Prevedenie čierna matná	CIM	19,50	23,40
Vlastný kľúč VK-EAP2pro S		5,00	6,00

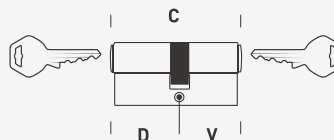

bezpečnostná vložka **AP2pro S**

Precízne spracovanie a kvalitné materiály zaručujú dlhú životnosť a funkčnosť cylindrickej vložky.

bezpečnostná vložka **SAMOSTATNÁ**

AP2pro S

obojstranná vložka

NBU certifikát - b.t. 3 - stupeň utajenia „tajné“

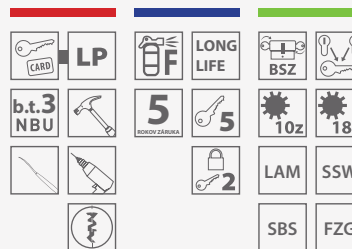

dormakaba

- samostatná bezpečnostná vložka, s ochranou proti odvrtaniu
- bezpečnostná trieda b.t. 3 s prekrytým profilom
- súčasťou vložky je 5 kľúčov + bezpečnostná karta
- LP - licenčný profil – výroba kópií kľúčov u všetkých licenčných partnerov spoločnosti dormakaba na Slovensku, výhradne po predložení bezp. karty
- BSZ funkcia - odomykanie pri zasunutom a pootočenom kľúči na opačnej strane je za príplatok
- možnosť zjednotenia viacerých vložiek na spoločný kľúč za príplatok
- odolná proti planžetovaniu a „bumping“ metóde
- možnosť kombinovať s vložkou EAP2pro S
- 5-ročná záruka
- vhodná do protipožiarnych dverí

Cena bez DPH
od **39€**

Cena s DPH od **46€**



OVERTE
CENU A
DOSTUPNOSŤ

- bezpečnostné prvky

- štandardné prvky

- príplatkové prvky

DK - SAMOSTATNÁ CYLINDRICKÁ VLOŽKA

AP2pro S

OBOJSTRANNÁ VLOŽKA	rozmer D+V v mm	rozmer C v mm	v € bez DPH	s DPH
AP2pro S	27,5 + 27,5	55	38,50	46,20
AP2pro S	30 + 30	60	38,50	46,20
AP2pro S	27,5 + 35,5	63	39,10	46,92
AP2pro S	30 + 35,5	65,5	39,10	46,92
AP2pro S	27,5 + 40	67,5	39,60	47,52
AP2pro S	30 + 40	70	39,60	47,52
AP2pro S	35,5 + 35,5	71	39,60	47,52
AP2pro S	27,5 + 45	72,5	42,90	51,48
AP2pro S	30 + 45	75	42,90	51,48
AP2pro S	35,5 + 40	75,5	42,90	51,48
AP2pro S	30 + 50	80	46,10	55,32
AP2pro S	40 + 40	80	46,10	55,32
AP2pro S	35,5 + 45	80,5	46,10	55,32
AP2pro S	30 + 55	85	49,30	59,16
AP2pro S	40 + 45	85	49,30	59,16
AP2pro S	35,5 + 50	85,5	49,30	59,16
AP2pro S	30 + 60	90	54,30	65,16
AP2pro S	40 + 50	90	54,30	65,16
AP2pro S	45 + 45	90	54,30	65,16
AP2pro S	35,5 + 55	90,5	54,30	65,16
AP2pro S	45 + 50	95	59,30	71,16
AP2pro S	40 + 55	95	59,30	71,16
AP2pro S	30 + 65	95	59,30	71,16
AP2pro S	35,5 + 60	95,5	59,30	71,16
AP2pro S	40 + 60	100	64,30	77,16
AP2pro S	45 + 55	100	64,30	77,16
AP2pro S	30 + 70	100	64,30	77,16
AP2pro S	50 + 50	100	64,30	77,16
AP2pro S	35,5 + 65	100,5	64,30	77,16
AP2pro S	45 + 60	105	69,20	83,04

OBOJSTRANNÁ VLOŽKA	rozmer D+V v mm	rozmer C v mm	v € bez DPH	s DPH
AP2pro S	30 + 75	105	69,20	83,04
AP2pro S	50 + 60	110	74,20	89,04
AP2pro S	55 + 55	110	74,20	89,04
Príplatok za 5 mm navyč			8,50	10,20

NADŠTANDARDNÉ PŘEVEDENIA	Označenie	v € bez DPH	s DPH
Núdzová funkcia	BSZ	21,00	25,20
Zjednotenie vložiek	SK	10,00	12,00
Vložka s voľnobežným palcom	FZG	22,70	27,24
Ozubené koliesko s 10 zubami	ZR10	10,10	12,12
Ozubené koliesko s 18 zubami	ZR18	14,10	16,92
Vložka s oceľovou výstuhou	LAM	33,00	39,60
Ochrana proti prachu a vode	SSW	83,60	100,32
Ochrana proti rozlomeniu vložky	SBS	9,80	11,76
Zastepovací inžert	BL	7,80	9,36
Prevedenie zlatá matná	ZLM	5,00	6,00
Prevedenie zlatá lesklá	ZLL	18,00	21,60
Prevedenie čierna matná	CIM	19,50	23,40
Vlastný kľúč VK-AP2pro S		5,00	6,00

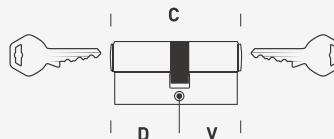

bezpečnostná vložka **EAP2000 S**

Precízne spracovanie a kvalitné materiály zaručujú dlhú životnosť a funkčnosť cylindrickej vložky.

bezpečnostná vložka **SAMOSTATNÁ**

EAP2000 S

obojstranná vložka

STN EN 1627 - b.t. 3

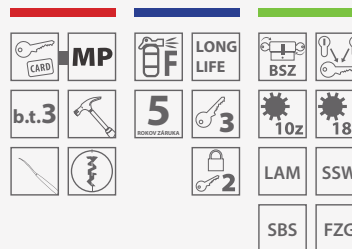

dormakaba

- samostatná bezpečnostná vložka, bez ochrany proti odvráteniu
- bezpečnostná trieda b.t. 3 s prekrytým profilom
- súčasťou vložky sú 3 kľúče + identifikačná karta
- MP profil – zvýšená ochrana kopírovania kľúčov. Výroba kópií kľúčov len v spoločnosti MP KOVANIA, výhradne po predložení bezpečnostnej karty
- BSZ funkcia - odomykanie pri zasunutom a pootočenom kľúči na opačnej strane je za príplatok
- možnosť zjednotenia viacerých vložiek na spoločný kľúč za príplatok
- odolná proti planžetovaniu a „bumping“ metóde
- 5-ročná záruka
- vhodná do protipožiarnych dverí

Cena bez DPH
od **22€**

Cena s DPH od **26€**



OVERTE
CENU A
DOSTUPNOSŤ

— - bezpečnostné prvky

— - štandardné prvky

— - príplatkové prvky

DK - SAMOSTATNÁ CYLINDRICKÁ VLOŽKA

EAP2000 S

OBOJSTRANNÁ VLOŽKA	rozmer D+V v mm	rozmer C v mm	v € bez DPH	s DPH
EAP2000 S	27,5 + 27,5	55	21,70	26,04
EAP2000 S	30 + 30	60	21,70	26,04
EAP2000 S	27,5 + 35,5	63	23,00	27,60
EAP2000 S	30 + 35,5	65,5	23,00	27,60
EAP2000 S	27,5 + 40	67,5	25,70	30,84
EAP2000 S	30 + 40	70	25,70	30,84
EAP2000 S	35,5 + 35,5	71	25,70	30,84
EAP2000 S	27,5 + 45	72,5	28,40	34,08
EAP2000 S	30 + 45	75	28,40	34,08
EAP2000 S	35,5 + 40	75,5	28,40	34,08
EAP2000 S	30 + 50	80	31,20	37,44
EAP2000 S	40 + 40	80	31,20	37,44
EAP2000 S	35,5 + 45	80,5	31,20	37,44
EAP2000 S	30 + 55	85	33,90	40,68
EAP2000 S	40 + 45	85	33,90	40,68
EAP2000 S	35,5 + 50	85,5	33,90	40,68
EAP2000 S	30 + 60	90	38,10	45,72
EAP2000 S	40 + 50	90	38,10	45,72
EAP2000 S	45 + 45	90	38,10	45,72
EAP2000 S	35,5 + 55	90,5	38,10	45,72
EAP2000 S	45 + 50	95	42,30	50,76
EAP2000 S	40 + 55	95	42,30	50,76
EAP2000 S	30 + 65	95	42,30	50,76
EAP2000 S	35,5 + 60	95,5	42,30	50,76
EAP2000 S	40 + 60	100	46,50	55,80
EAP2000 S	45 + 55	100	46,50	55,80
EAP2000 S	30 + 70	100	46,50	55,80
EAP2000 S	50 + 50	100	46,50	55,80
EAP2000 S	35,5 + 65	100,5	46,50	55,80
EAP2000 S	45 + 60	105	50,70	60,84

OBOJSTRANNÁ VLOŽKA	rozmer D+V v mm	rozmer C v mm	v € bez DPH	s DPH
EAP2000 S	30 + 75	105	50,70	60,84
EAP2000 S	50 + 60	110	54,90	65,88
EAP2000 S	55 + 55	110	54,90	65,88
Príplatok za 5 mm navyč			8,50	10,20

NADŠTANDARDNÉ PŘEVEDENIA	Označenie	v € bez DPH	s DPH
Núdzová funkcia	BSZ	21,00	25,20
Zjednotenie vložiek	SK	10,00	12,00
Vložka s voľnobežným palcom	FZG	22,70	27,24
Ozubené koliesko s 10 zubami	ZR10	10,10	12,12
Ozubené koliesko s 18 zubami	ZR18	14,10	16,92
Vložka s oceľovou výstuhou	LAM	33,00	39,60
Ochrana proti prachu a vode	SSW	83,60	100,32
Ochrana proti rozlomeniu vložky	SBS	9,80	11,76
Zastepovací inžert	BL	7,80	9,36
Prevedenie zlatá matná	ZLM	5,00	6,00
Prevedenie zlatá lesklá	ZLL	18,00	21,60
Prevedenie čierna matná	CIM	19,50	23,40
Vlastný kľúč VK-EAP2000 S		6,00	7,20

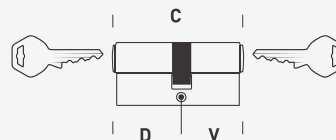

bezpečnostná vložka **EAP2000 US**

Precízne spracovanie a kvalitné materiály zaručujú dlhú životnosť a funkčnosť cylindrickej vložky.

bezpečnostná vložka **DO SYSTÉMOV**

EAP2000 US

obojstranná vložka

STN EN 1627 - b.t. 3

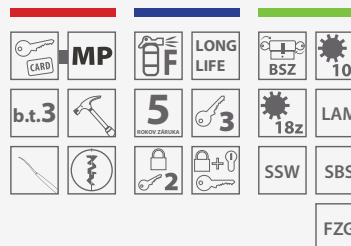

dormakaba

- **systemová bezpečnostná vložka, bez ochrany proti odvrátniu**
- **bezpečnostná trieda b.t. 3 s prekrytým profilom**
- **súčasťou vložky sú 3 kľúče + identifikačná systémová karta**
- **MP profil – zvýšená ochrana kopírovania kľúčov. Výroba kópií kľúčov len v spoločnosti MP KOVANIA, výhradne po predložení bezpečnostnej karty**
- **BSZ funkcia - odomykanie pri zasunutom a pootočenom kľúči na opačnej strane je za príplatok**
- **odolná proti planžetovaniu a „bumping“ metóde**
- **5-ročná záruka**
- **vhodná do protipožiarnych dverí**

Cena bez DPH
od **49€**

Cena s DPH od **59€**



OVERTE
CENU A
DOSTUPNOSŤ

— - bezpečnostné prvky

— - štandardné prvky

— - príplatkové prvky

DK - CYLINDRICKÁ VLOŽKA DO UZAMYKACÍCH SYSTÉMOV EAP2000 US

OBOJSTRANNÁ VLOŽKA	rozmer D+V v mm	rozmer C v mm	v € bez DPH	s DPH
EAP2000 US	27,5 + 27,5	55	48,80	58,56
EAP2000 US	30 + 30	60	48,80	58,56
EAP2000 US	27,5 + 35,5	63	49,80	59,76
EAP2000 US	30 + 35,5	65,5	49,80	59,76
EAP2000 US	27,5 + 40	67,5	52,00	62,40
EAP2000 US	30 + 40	70	52,00	62,40
EAP2000 US	35,5 + 35,5	71	52,00	62,40
EAP2000 US	27,5 + 45	72,5	54,30	65,16
EAP2000 US	30 + 45	75	54,30	65,16
EAP2000 US	35,5 + 40	75,5	54,30	65,16
EAP2000 US	30 + 50	80	56,50	67,80
EAP2000 US	40 + 40	80	56,50	67,80
EAP2000 US	35,5 + 45	80,5	56,50	67,80
EAP2000 US	30 + 55	85	58,70	70,44
EAP2000 US	40 + 45	85	58,70	70,44
EAP2000 US	35,5 + 50	85,5	58,70	70,44
EAP2000 US	30 + 60	90	62,10	74,52
EAP2000 US	40 + 50	90	62,10	74,52
EAP2000 US	45 + 45	90	62,10	74,52
EAP2000 US	35,5 + 55	90,5	62,10	74,52
EAP2000 US	45 + 50	95	65,60	78,72
EAP2000 US	40 + 55	95	65,60	78,72
EAP2000 US	30 + 65	95	65,60	78,72
EAP2000 US	35,5 + 60	95,5	65,60	78,72
EAP2000 US	40 + 60	100	69,00	82,80
EAP2000 US	45 + 55	100	69,00	82,80
EAP2000 US	30 + 70	100	69,00	82,80
EAP2000 US	50 + 50	100	69,00	82,80
EAP2000 US	35,5 + 65	100,5	69,00	82,80
EAP2000 US	45 + 60	105	72,40	86,88

OBOJSTRANNÁ VLOŽKA	rozmer D+V v mm	rozmer C v mm	v € bez DPH	s DPH
EAP2000 US	30 + 75	105	72,40	86,88
EAP2000 US	50 + 60	110	75,90	91,08
EAP2000 US	55 + 55	110	75,90	91,08
Príplatok za 5 mm navyč			8,50	10,20

NADŠTANDARDNÉ PŘEVEDENIA	Označenie	v € bez DPH	s DPH
Núdzová funkcia	BSZ	21,00	25,20
Vložka s voľnobežným palcom	FZG	22,70	27,24
Ozubené koliesko s 10 zubami	ZR10	10,10	12,12
Ozubené koliesko s 18 zubami	ZR18	14,10	16,92
Vložka s oceľovou výstuhou	LAM	33,00	39,60
Ochrana proti prachu a vode	SSW	83,60	100,32
Ochrana proti rozlomeniu vložky	SBS	9,80	11,76
Zastepovací inzert	BL	7,80	9,36
Prevedenie zlatá matná	ZLM	5,00	6,00
Prevedenie zlatá lesklá	ZLL	18,00	21,60
Prevedenie čierna matná	CIM	19,50	23,40
Vlastný kľúč VK-EAP2000 US		7,00	8,40
Hlavný kľúč HK-EAP2000 US		9,00	10,80
Generálny kľúč GK-EAP2000 US		9,00	10,80

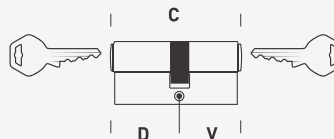

MPK®

DOPLNKY

KOVANIA
NA SKLO





VYSVETLIVKY



obsahuje vratný mechanizmus
kľučky - pružinu



súčasťou balenia je sada skrutiek
na preskrutkovanie cez dvere

set na sklo bez otvoru P

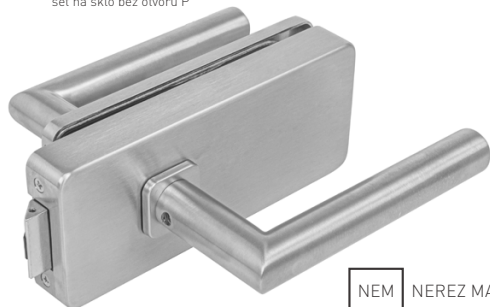

set na sklo bez otvoru Z



set na sklo PZ



NEM NEREZ MATNÁ

set na sklo BBQ

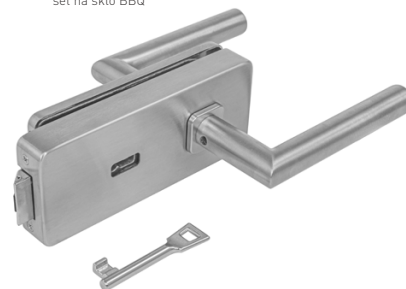

set na sklo WC



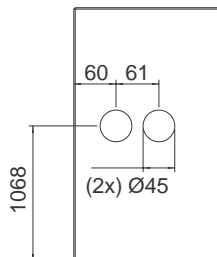
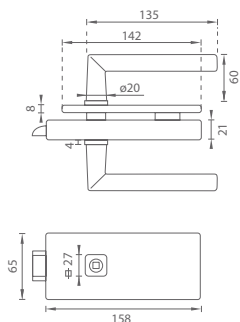

MATERIÁL: NEREZ



i Pre hrúbku skla 8 - 10 mm



MP - SET NA SKLO UNIQUE R8 - FAVORIT

	Cena za set v €	bez DPH	s DPH
zámok na sklo bez otvoru P		87,50	105,00
zámok na sklo bez otvoru Z		87,50	105,00
zámok na sklo BBQ otvor		94,50	113,40
zámok na sklo PZ otvor		89,50	107,40
zámok na sklo WC set		105,50	126,60
protikus na sklo		70,00	84,00

OVERTE CENU



protikus

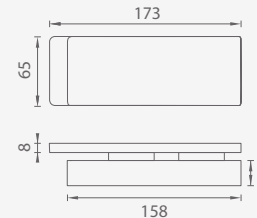

set na sklo bez otvoru P



CIM ČIERNA MATNÁ

set na sklo bez otvoru Z



set na sklo PZ



set na sklo BBQ

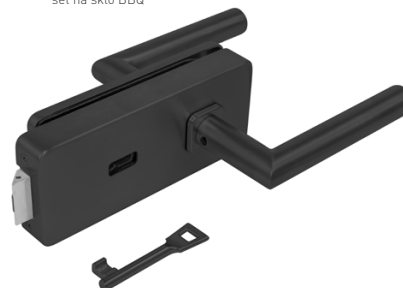

set na sklo WC

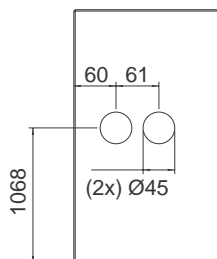
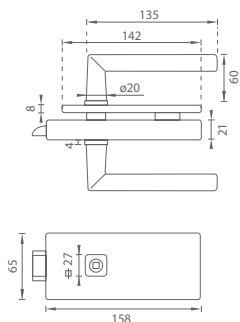



i Pre hrúbku skla 8 - 10 mm

MATERIÁL: NEREZ



MP - SET NA SKLO UNIQUE R8 - FAVORIT

	Cena za set v €	bez DPH	s DPH
zámok na sklo bez otvoru P		97,50	117,00
zámok na sklo bez otvoru Z		97,50	117,00
zámok na sklo BBQ otvor		104,50	125,40
zámok na sklo PZ otvor		99,50	119,40
zámok na sklo WC set		115,50	138,60
protikus na sklo		75,00	90,00

OVERTE CENU



protikus

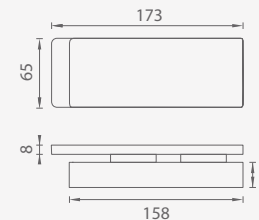

set na sklo bez otvoru P

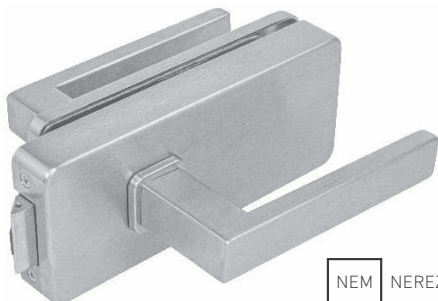

set na sklo bez otvoru Z

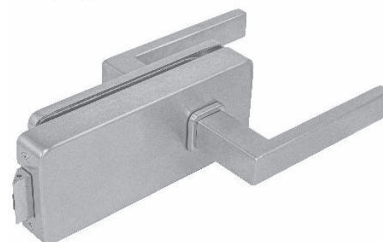

set na sklo PZ

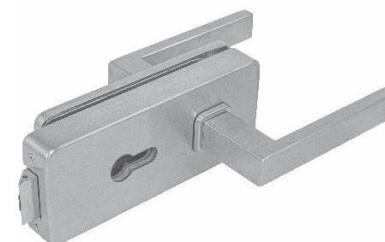

NEM NEREZ MATNÁ

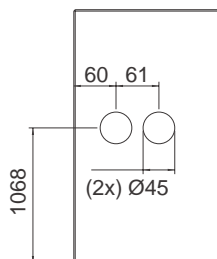
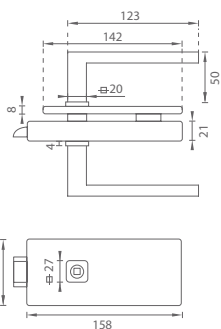

set na sklo BBQ

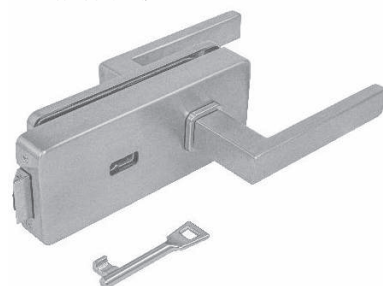

set na sklo WC

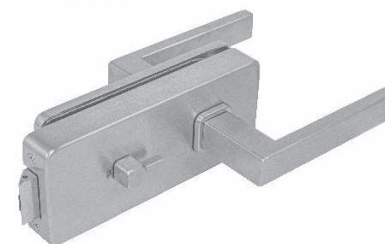



MATERIÁL: NEREZ

i Pre hrúbku skla 8 - 10 mm



MP - SET NA SKLO UNIQUE R8 - QUADRA

	Cena za set v €	bez DPH	s DPH
zámok na sklo bez otvoru P		95,00	114,00
zámok na sklo bez otvoru Z		95,00	114,00
zámok na sklo BBQ otvor		102,00	122,40
zámok na sklo PZ otvor		97,00	116,40
zámok na sklo WC set		113,00	135,60
protikus na sklo		70,00	84,00

OVERTE CENU



protikus

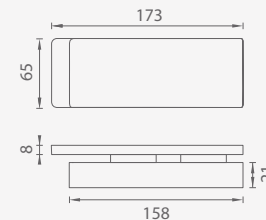

set na sklo bez otvoru P



CIM ČIERNA MATNÁ

set na sklo bez otvoru Z

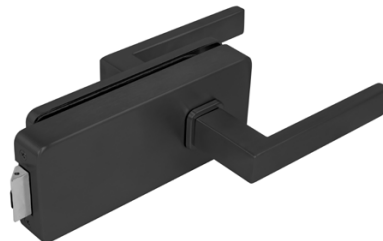

set na sklo PZ

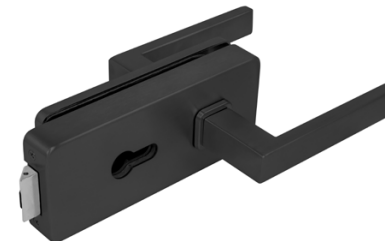

set na sklo BBQ



set na sklo WC

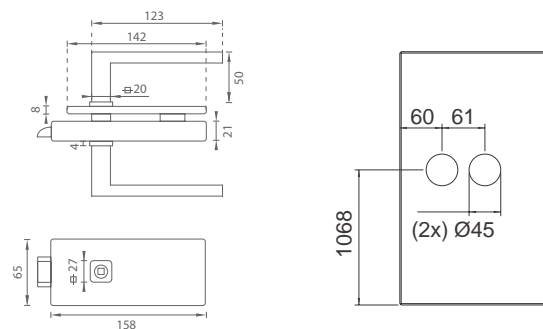
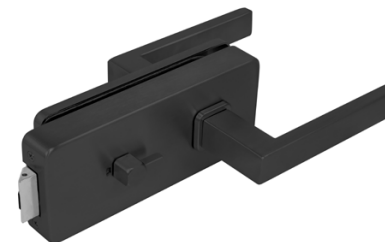

i Pre hrúbku skla 8 - 10 mm

MATERIÁL: NEREZ



MP - SET NA SKLO UNIQUE R8 - QUADRA

	Cena za set v €	bez DPH	s DPH
zámok na sklo bez otvoru P		105,00	126,00
zámok na sklo bez otvoru Z		105,00	126,00
zámok na sklo BBQ otvor		112,00	134,40
zámok na sklo PZ otvor		107,00	128,40
zámok na sklo WC set		123,00	147,60
protikus na sklo		75,00	90,00

OVERTE CENU



protikus

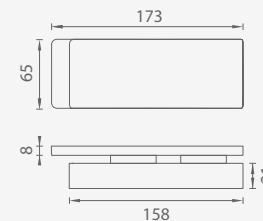

pánt vertikálny
s platničkou

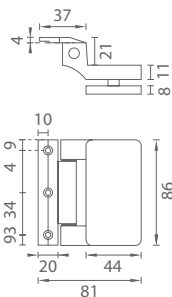
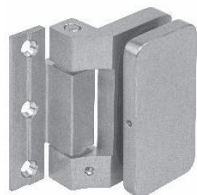

pánt vertikálny

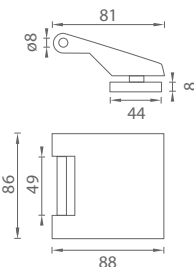

pánt horizontálny
s platničkou

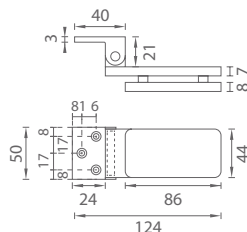
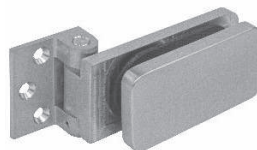

pánt horizontálny

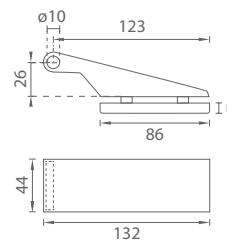
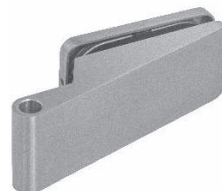

PZ predženie

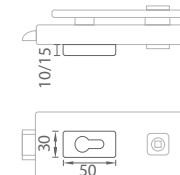

MATERIÁL: NEREZ

NEM NEREZ MATNÁ

i Pre hrúbku skla 8 - 10 mm



MP - DOPLNKY - UNIQUE R8

	Cena v €	bez DPH	s DPH
pánt vertikálny s platničkou - pár		99,00	118,80
pánt vertikálny - pár		78,00	93,60
pánt horizontálny s platničkou - pár		94,00	112,80
pánt horizontálny - pár		74,00	88,80
PZ predženie 10 mm samolepiace - kus	15,00		18,00
PZ predženie 15 mm samolepiace - kus	18,00		21,60

**OVERTE
CENU**

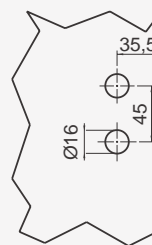

Pre záves vertikálny
a vertikálny s platničkou

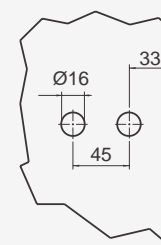

Pre záves horizontálny
a horizontálny s platničkou

pánt vertikálny
s platničkou

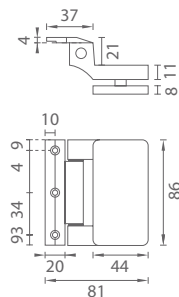

pánt vertikálny

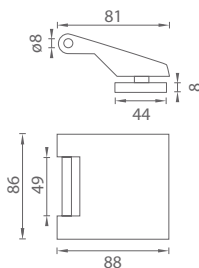

pánt horizontálny
s platničkou

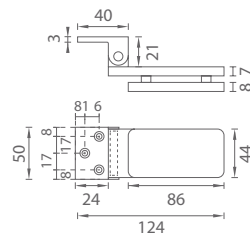

pánt horizontálny

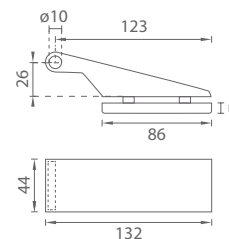

PZ predĺženie

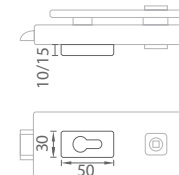

CIM ČIERNA MATNÁ

i Pre hrúbku skla 8 - 10 mm



MP - DOPLNKY - UNIQUE R8

	Cena za set v €	bez DPH	s DPH
pánt vertikálny s platničkou - pár		104,00	124,80
pánt vertikálny - pár		83,00	99,60
pánt horizontálny s platničkou - pár		99,00	118,80
pánt horizontálny - pár		79,00	94,80
PZ predĺženie 10 mm samolepiace - kus	16,00		19,20
PZ predĺženie 15 mm samolepiace - kus	19,00		22,80

OVERTE
CENU

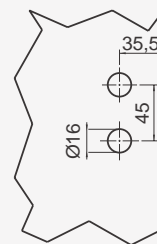

Pre záves vertikálny
a vertikálny s platničkou

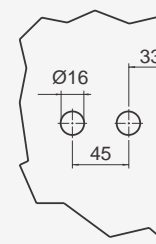

Pre záves horizontálny
a horizontálny s platničkou

ABECEDNÝ ZOZNAM

AGB - MAGNETICKÝ ZÁMOK MEDIANA POLARIS	384
AGB - PROTIPLÉCH MEDIANA POLARIS	385
AGB - ZÁSTRČ DVERÍ F16 - H150	397
AGB - ZÁSTRČ DVERÍ F16 - H250	397
AS - BRISA - RT 7S	233
AS - CARLINA - RT 7S	230
ASG - GUAVA - RT	236
ASG - GUAVA - RT S UZAMYKANÍM	236
ASG - HEDERA - RT	234
ASG - HEDERA - RT S UZAMYKANÍM	234
AS - ISMENA - HR 7S	226
AS - LILA - HR 7S	228
AS - LUPINA - RT 7S	232
AS - MELA - HR 7S	229
ASM - MARI GOLD 3 - R 7S	220
AS - PINA - HR 7S	227
AS - PLUMERIA - RT 7S	231
AT - ARABIS - HR 7S	224
AT - ARABIS - R 7S	216
AT - FRAGOLA - R 7S	217
AT - MOLINIA - DKO 7S	278
AT - MOLINIA - R 7S	218
AT - SULLA - HR 7S	225
AXA - BETA 2 PLUS - SOK	292
AXA - MENOVKA S PRIEZORNÍKOM ATLAS 2/OMEGA 2	449
AXA - MENOVKA S PRIEZORNÍKOM BETA 2	449
AXA - OMEGA 2 PLUS - SHK	294
AXA - ROZETA ATLAS 2 PLUS/OMEGA 2 PLUS - UHR	295
AXA - ROZETA BETA 2 PLUS - UOR	293
BA - CLAUDIA - R	30
BA - CLAUDIA - SO	30
BA - LUCIA - DKH	264
BA - LUCIA - OLIVA	266
BA - LUCIA - POLOLIVA	265
BA - LUCIA - R	23
BA - LUCIA - ROZVORA	267
BA - LUCIA - SH	22
BA - LUXOR B - SO	20
BA - LUXOR - R	21
BA - LUXOR - R	28
BA - LUXOR - SO	28
BA - MIRA - R	27
BA - MIRA - SO	26
BA - NERO - R	33
BA - NERO - SO	33
BA - NEVADA - R	32
BA - NEVADA - SO	32

BA - TORNADO - R	31
BA - TORNADO - R	25
BA - TORNADO - SO	31
BA - TORNADO - SO	24
CE - CASTA - R	34
CE - CASTA - R	34
CE - FLAT - HR	35
CE - FLAT - HR	35
CO - PRAHOVÁ VÝSUVNÁ LIŠTA - 1700 MINI	401
CO - PRAHOVÁ VÝSUVNÁ LIŠTA - 1712	401
CO - PRAHOVÁ VÝSUVNÁ LIŠTA - 1750	403
CO - PRAHOVÁ VÝSUVNÁ LIŠTA - 1773 ACU	402
CO - PRAHOVÁ VÝSUVNÁ LIŠTA - 1800 XNS	403
CO - PRAHOVÁ VÝSUVNÁ LIŠTA - 1812	402
DK - CYLINDRICKÁ VLOŽKA DO UZAMYKACÍCH SYSTÉMOV EAP2000 US	467
DK - D1/1B	424
DK - D2/1H-1D-1B	425
DK - KOMPONENTY ZO SETOV	424
DK - KOMPONENTY ZO SETOV	425
DK - KOVANIE	426
DK - KOVANIE PHT 10 - SHK NEM	438
DK - KOVANIE PHT 10 - SHK STM	438
DK - PHA 1000 - D1/1B - NEM	430
DK - PHA 1000 - D1/1B - STM	430
DK - PHA 1000 - D1/1H-1D - NEM	431
DK - PHA 1000 - D1/1H-1D - STM	431
DK - PHA 1000 - D2/1H-1D-1B - NEM	432
DK - PHA 1000 - D2/1H-1D-1B - STM	432
DK - PHA 1000 - D2/2H-2D - NEM	433
DK - PHA 1000 - D2/2H-2D - STM	433
DK - PHB 1000 - D1/1B - NEM	434
DK - PHB 1000 - D1/1B - STM	434
DK - PHB 1000 - D1/1H-1D - NEM	435
DK - PHB 1000 - D1/1H-1D - STM	435
DK - PHB 1000 - D2/1H-1D-1B - NEM	436
DK - PHB 1000 - D2/1H-1D-1B - STM	436
DK - PHB 1000 - D2/2H-2D - NEM	437
DK - PHB 1000 - D2/2H-2D - STM	437
DK - SAMOSTATNÁ CYLINDRICKÁ VLOŽKA AP2pro S	463
DK - SAMOSTATNÁ CYLINDRICKÁ VLOŽKA AP1000 S	459
DK - SAMOSTATNÁ CYLINDRICKÁ VLOŽKA EAP2pro S	461
DK - SAMOSTATNÁ CYLINDRICKÁ VLOŽKA EAP2000 S	465
FO - ALILA - HR	256
FO - ASTI - HR	248
FO - ASTI HS PORTAL - SHK	286
FO - ASTI HS PORTAL - SHK	287
FO - BOSTON - HR	250
FO - CARINA - R	246
FO - CARINA - SO	247
FO - CHICAGO - R	242

ABECEDNÝ ZOZNAM

FO - CRYSTAL - HR	249
FO - DIANA - HR	255
FO - FAN - R	244
FO - FAN - SO	245
FO - ICON - RT	259
FO - LORENA - HR	251
FO - MILLY - R	240
FO - MINERVA - HR	254
FO - NAXOS - HR	252
FO - PARIS - HR	257
FO - PENTA - RT	258
FO - ROUND - R	241
FT - K00/Ø30 - MADLO	316
FT - K00/Ø30 - MADLO	317
FT - K01/Ø32 - MADLO	312
FT - K01/Ø32 - MADLO	313
FT - K02K/25X25 - MADLO	320
FT - K02K/25X25 - MADLO	321
FT - K10/Ø30 - MADLO	318
FT - K10/Ø30 - MADLO	319
FT - K14T/Ø32 - MADLO	314
FT - K14T/Ø32 - MADLO	315
FT - K41C/40X10 - MADLO	322
FT - K41C/40X10 - MADLO	323
FT - MUŠLA HRANATÁ 3663	330
FT - MUŠLA HRANATÁ 3663 S UZAMYKANÍM	331
FT - MUŠLA OVÁLNÁ 3665	328
FT - MUŠLA OVÁLNÁ 3665 S UZAMYKANÍM	329
FT - SPOJOVACÍ MATERIÁL	310
FT - SPOJOVACÍ MATERIÁL	311
FT - ZÁMOK NA POSUVNÉ DVERE - BB 60/50	386
FT - ZÁMOK NA POSUVNÉ DVERE - PZ 62/50	388
FT - ZÁMOK NA POSUVNÉ DVERE - WC 61/50	389
GA - KONSTANZ - SO	181
GK - AVUS ONE	212
GK - AVUS ONE - S2L	210
GK - R8 ONE	208
GK - R8 ONE - S2L	206
GZ - SAMOZATVÁRAČ TS - 1000	412
GZ - SAMOZATVÁRAČ TS - 1500	413
GZ - SAMOZATVÁRAČ TS - 1500 G	416
GZ - SAMOZATVÁRAČ TS - 2000 NV	414
GZ - SAMOZATVÁRAČ TS - 3000	417
GZ - SAMOZATVÁRAČ TS - 4000	415
GZ - SAMOZATVÁRAČ TS - 5000, TS - 5000 L	418
JNF - MUŠLA HRANATÁ	332
JNF - POSUVNÝ SYSTÉM IN.15.900 NA SKLO	372

JNF - POSUVNÝ SYSTÉM IN.15.901	368
JNF - POSUVNÝ SYSTÉM IN.15.903	370
JNF - STAVAČ DVERÍ	396
JNF - ZARÁŽKA DVERÍ - IN.13.121.20	392
JNF - ZARÁŽKA DVERÍ OVÁLNÁ	393
JNF - ZARÁŽKA DVERÍ OVÁLNÁ	393
KE - LAURA - SO	18
KE - MICHAELA - SO	19
KZ - SKRYTÝ ZÁVES ATOMIKA - K 8060/8080	376
KZ - SKRYTÝ ZÁVES KUBICA - K 2460	378
KZ - SKRYTÝ ZÁVES KUBICA - K 5080	379
KZ - SKRYTÝ ZÁVES KUBICA - K 6200	377
LR - ČÍSLICA A PÍSMENO 60 NALEPOVACIE	452
LR - ČÍSLICA A PÍSMENO 120 NALEPOVACIE	452
LR - ČÍSLICA A PÍSMENO 120 SO SKRUTKAMI	453
LR - TILLY - SHU	179
LR - TILLY - SO	180
LR - TILLY - UOR	178
MADIELKO DO ČELA HRANATÉ	345
MADIELKO DO ČELA OVÁLNE	344
MP - ALT WIEN - DKO	142
MP - ALT WIEN GUĽA PEVNÁ - SO	141
MP - ALT WIEN - POLOLIVA	144
MP - ALT WIEN - ROZVORA	143
MP - ALT WIEN - SO	140
MP - APOLO - HR 3SM	89
MP - APOLO - HR 3SM	89
MP - BISKIT - DKH	271
MP - BISKIT - DKH	271
MP - BISKIT - HR	120
MP - COSLAN - R	42
MP - COSLAN - SO	59
MP - COSLAN ŠPECIÁL - SO	62
MP - COSLAN ŠPECIÁL - SOK	64
MP - COSLAN - UOR	74
MP - CYLINDRICKÁ VLOŽKA WC S GOMBÍKOM	457
MP - CYNTHIA - DKH	273
MP - CYNTHIA - DKH	273
MP - CYNTHIA - HR	118
MP - CYNTHIA - HR SQ6	102
MP - DANIELA - HR	55
MP - DANIELA - HR	55
MP - DANIELA - R	43
MP - DANIELA - SH	66
MP - DANIELA - SO	61
MP - DOPLNKY - UNIQUE R8	474
MP - DOPLNKY - UNIQUE R8	475
MP - ELEGANT - DKO	160
MP - ELEGANT GUĽA PEVNÁ - SO	159
MP - ELEGANT - POLOLIVA	162

ABECEDNÝ ZOZNAM

MP - ELEGANT - ROZVORA	161
MP - ELEGANT - SO	158
MP - ELIPTICA - DKO	270
MP - ELIPTICA - DKO	270
MP - ELIPTICA - R S6	96
MP - ESSO - HR	52
MP - ESSO - HR	52
MP - ESSO - R	44
MP - ESSO - R	44
MP - FAN ECO - SO	137
MP - FAVORIT - DKO	268
MP - FAVORIT - DKO	268
MP - FAVORIT - HR	48
MP - FAVORIT - HR	48
MP - FAVORIT - HR 3SM	88
MP - FAVORIT - HR 3SM	88
MP - FAVORIT - R	40
MP - FAVORIT - R	40
MP - FAVORIT - R 3SM	84
MP - FAVORIT - R 3SM	84
MP - FAVORIT - SH	66
MP - FAVORIT - SHU	70
MP - FAVORIT - SO	58
MP - FAVORIT - SO	58
MP - FAVORIT ŠPECIÁL - SO	62
MP - FAVORIT - UOR	72
MP - FAVORIT - UOR	72
MP - GUĽA PEVNÁ - HR	57
MP - GUĽA PEVNÁ - R	135
MP - GUĽA PEVNÁ - R	125
MP - GUĽA PEVNÁ - R	47
MP - GUĽA PEVNÁ - R	47
MP - GUĽA PEVNÁ - R	47
MP - GUĽA PEVNÁ - R 3SM	87
MP - GUĽA PEVNÁ - R S6	97
MP - GUĽA PEVNÁ - SH	68
MP - GUĽA PEVNÁ - SO	61
MP - GUĽA PEVNÁ ŠPECIÁL - SO	63
MP - GUĽA PEVNÁ ŠPECIÁL - SOK	64
MP - GUĽA PEVNÁ VYOSENÁ - UOR	77
MP - GUĽA PEVNÁ VYOSENÁ - UOR	78
MP - GUĽA VYOSENÁ PEVNÁ PLOCHÁ - UOR	76
MP - GUĽA VYOSENÁ PEVNÁ PLOCHÁ - UOR	76
MP - GUĽA VYOSENÁ - UOR	77
MP - GUĽA VYOSENÁ - UOR	78
MP - HIT - DKH	276
MP - HIT - HR SQ6	106
MP - HOLLY - DKH	272

MP - HOLLY - DKH	272
MP - HOLLY - HR	114
MP - HOLLY - HR SQ6	98
MP - JASPER - HR	116
MP - JULIA - SO	176
MP - KOORDINÁTOR ZATVÁRANIA	426
MP - LAURA ECO - SO	136
MP - LAURA GUĽA PEVNÁ - SO	139
MP - LAURA - SO	138
MP - LEONTINA - DKO	277
MP - LEONTINA - R	132
MP - LEONTINA - SO	132
MP - MADLO PEVNÉ - HR	123
MP - MADLO PEVNÉ - HR 3SM	91
MP - MADLO PEVNÉ - HR SQ6	109
MP - MADLO PEVNÉ VYOSENÉ - HR	57
MP - MADLO PEVNÉ VYOSENÉ - SH	68
MP - MADLO PEVNÉ VYOSENÉ - SHU	71
MP - MARENA - R 3SM	85
MP - MODERNA - HR	50
MP - MONA - R	41
MP - MONA - SO	59
MP - MONA - UOR	74
MP - MUŠĽA HRANATÁ 039	327
MP - MUŠĽA OVÁĽNA 040	326
MP - NERO - HR	50
MP - NERO - R	41
MP - NERO - SO	60
MP - NERO - UOR	73
MP - NERO - UOR	73
MP - OKOPOVÝ PLECH - FÓLIOVANÝ, SAMOLEPIACI - KUS	442
MP - PRADO - R 3SM	85
MP - PRIEZORNÍK SET	448
MP - PRIEZORNÍK S KRYTKOU	448
MP - PRIMA - DKH	275
MP - PRIMA - HR SQ6	104
MP - QUADRA - DKH	269
MP - QUADRA - DKH	269
MP - QUADRA - HR	53
MP - QUADRA - HR	53
MP - QUADRA - SH	67
MP - QUADRA - SH	67
MP - QUADRA - SHU	70
MP - ROMEO A JULIA GUĽA PEVNÁ - SO	177
MP - ROMEO - SO	174
MP - ROZETA - HR	56
MP - ROZETA - HR	56
MP - ROZETA - HR	122
MP - ROZETA - HR 3SM	90
MP - ROZETA - HR SQ6	108

ABECEDNÝ ZOZNAM

MP - ROZETA - R	46
MP - ROZETA - R	46
MP - ROZETA - R	125
MP - ROZETA - R	134
MP - ROZETA - R 3SM	86
MP - ROZETA - R S6	97
MP - ROZETA - UOR	75
MP - ROZETA - UOR	75
MP - SET NA SKLO UNIQUE R8 - FAVORIT	470
MP - SET NA SKLO UNIQUE R8 - FAVORIT	471
MP - SET NA SKLO UNIQUE R8 - QUADRA	472
MP - SET NA SKLO UNIQUE R8 - QUADRA	473
MP - SPIRIT - R	124
MP - SPIRIT - R	130
MP - STAVEBNÁ CYLINDRICKÁ VLOŽKA	456
MP - STAVEBNÁ CYLINDRICKÁ VLOŽKA S GOMBÍKOM	456
MP - SUNNY - HR	54
MP - SUNNY - HR	54
MP - SWING - HR	51
MP - SWING - R	42
MP - TORNADO - HR	51
MP - TORNADO - R	43
MP - TORNADO - SO	60
MP - VETRACIA MRIEŽKA HLINÍKOVÁ	446
MP - VIVA - DKH	274
MP - VIVA - DKH	274
MP - VIVA - HR SQ6	100
MP - ZÁMOK 72	382
MP - ZARÁŽKA DVERÍ - POLKOPULKA	392
NI - ALT WIEN - DKO	156
NI - ALT WIEN GULA PEVNÁ - SO	147
NI - ALT WIEN - OLIVA	153
NI - ALT WIEN PLUS - SO SPEVNENÉ KOVANIE	150
NI - ALT WIEN - POLOLIVA MALÁ 1	154
NI - ALT WIEN - POLOLIVA MALÁ 2	155
NI - ALT WIEN - POLOLIVA VEĽKÁ	157
NI - ALT WIEN - ROZVORA	152
NI - ALT WIEN - SO	146
NI - ALT WIEN - SO SPEVNENÉ KOVANIE	148
NI - ELEGANT - DKO	166
NI - ELEGANT GULA PEVNÁ - SO	165
NI - ELEGANT - OLIVA	170
NI - ELEGANT - POLOLIVA MALÁ	171
NI - ELEGANT - POLOLIVA VEĽKÁ	168
NI - ELEGANT - ROZVORA	169
NI - ELEGANT - SO	164
NI - RAMA GULA PEVNÁ - SO	173

NI - RAMA - SO	172
OV - BEZPEČNOSTNÁ POISTKA - SALVADITA	394
OV - TAŠKA NA ZÁVES JR 519	381
OV - ZÁVES 101/100	381
OV - ZÁVES 495	380
PR - MUŠĽA HARANTÁ 1096Z WC	337
PR - MUŠĽA HRANATÁ	336
PR - MUŠĽA HRANATÁ 1097Z	338
PR - MUŠĽA HRANATÁ 1158Z NA POSUVNÉ SKLENENÉ DVERE	339
PR - MUŠĽA OVÁĽNA	340
PR - ÚCHYTKA PUSH	343
PR - VÝKLOPNÁ ÚCHYTKA 1032Z	342
SAB - HOOKY ZERO - HR S UZAMYKANÍM	347
SAB - HOOKY ZERO - R S UZAMYKANÍM	346
SC - KOMPONENTY 100 SILENT DO 40 KG SP2	359
SC - KOMPONENTY 100 SILENT DO 40 KG SP2	361
SC - KOMPONENTY 100 SILENT DO 80 KG	351
SC - KOMPONENTY 100 SILENT DO 80 KG	353
SC - KOMPONENTY 100 SILENT DO 80 KG SP2	363
SC - KOMPONENTY 100 SILENT DO 80 KG SP2	365
SC - KOMPONENTY 100 SILENT DO 120 KG	355
SC - KOMPONENTY 100 SILENT DO 120 KG	357
SC - KOMPONENTY LEGGERA DO 70 KG	349
SC - POSUVNÝ SYSTÉM 1800 HIDDEN 40 / 80 KG SP	366
SC - SET 100 SILENT 1D 1500/80	350
SC - SET 100 SILENT 1D 1500/120	354
SC - SET 100 SILENT 1D 2000/80	350
SC - SET 100 SILENT 1D 2000/120	354
SC - SET 100 SILENT 2D 3000/80	352
SC - SET 100 SILENT 2D 3000/120	356
SC - SET 100 SILENT 2D 4000/80	352
SC - SET 100 SILENT 2D 4000/120	356
SC - SET 100 SILENT S 1D 1500/40 SP	358
SC - SET 100 SILENT S 1D 1500/80 SP	362
SC - SET 100 SILENT S 1D 2000/40 SP	358
SC - SET 100 SILENT S 1D 2000/80 SP	362
SC - SET 100 SILENT S 2D 3000/40 SP2	360
SC - SET 100 SILENT S 2D 3000/80 SP2	364
SC - SET 100 SILENT S 2D 4000/40 SP2	360
SC - SET 100 SILENT S 2D 4000/80 SP2	364
SC - SET LEGGERA 1D 1500/70	348
SC - SET LEGGERA 1D 2000/70	348
SRL - VETRACIA MRIEŽKA HLINÍKOVÁ	446
SS - ČÍSLICA 152 SO SKRUTKAMI	450
TD - DREVENÝ PRAH BUK - BRÚSENÝ	408
TD - DREVENÝ PRAH BUK - MORENÝ A LAKOVANÝ	409
TD - DREVENÝ PRAH DUB - BRÚSENÝ	404
TD - DREVENÝ PRAH DUB - KARTÁČOVANÝ A OLEJOVANÝ	406
TD - DREVENÝ PRAH DUB - MORENÝ A LAKOVANÝ	405

ABECEDNÝ ZOZNAM

TI - CINTO - DKH 2732Q	283
TI - CINTO - HR 5S 2732Q	193
TI - CUBO/NELA - R 3233/4158	298
TI - CUBO/SQUARE - HR 3230/2275	299
TI - ELIPTICA - DKH 3098Q	285
TI - ELIPTICA - DKO 3098	284
TI - ELIPTICA - HR 5S 3098Q	191
TI - ELIPTICA - R 5S 3098	190
TI - FAVORIT - DKH 2002Q	280
TI - FAVORIT - DKO 2002	280
TI - FAVORIT - R 5S 2002	188
TI - FORTE PLUS/SQUARE 3214/2275 - SHK	296
TI - GORDO - RT5 4084 S UZAMYKANÍM	202
TI - GORDO - RT 4084	201
TI - LINHA 2 - HR 5S 2730Q	194
TI - MAGNETICKÝ ZÁMOK	383
TI - MELODY - RT 3099	198
TI - MUŠLA HRANATÁ 4181 5S	334
TI - SALINAS - RT 4130	200
TI - SALVO/SQUARE 3199/2275 - SHU	297
TI - SQUARE - DKH 2275Q	281
TI - SQUARE - HR 5S 2275Q	192
TI - SUPRA - DKH 3097Q	282
TI - SUPRA - HR 5S 3097Q	196
TI - TIGA - HR 5S 4154Q	197
TI - ZARÁŽKA DVERÍ HRANATÁ - 2617	391
TI - ZARÁŽKA DVERÍ OVÁLNA - 115	390
WA - FELIX 2 - SHU	300
WA - FELIX 3 - SHU	301
WA - FELIX - UHR	302
WA - FELIX - UHR	303
WA - MADLO FELIX - UHR	304
WA - MADLO FELIX - UHR	305
ZPT - VETRACIA MRIEŽKA PLASTOVÁ	444
	5/5



MP[®]
KOVANIA

S VAMI OD ROKU 2002

MP KOVANIA®

KOVANIA NA DVERE, STAVBY A NÁBYTOK



MP KOVANIA s.r.o.

Nová Rožňavská 1 | 831 04 Bratislava

+421 2 444 555 85 | mp@mp-kovania.sk

mp-kovania.sk